

CIRCULATION LARGER THAN ALL OTHER RADIO MAGAZINES COMBINED

RADIO NEWS

REG. U.S. PAT. OFF.

20 Cents

August

1921

Over 100 Illustrations

Edited by H. GERNSBACH

RADIO IN A
NEW YORK STOCK EXCHANGE
SEE PAGE 102



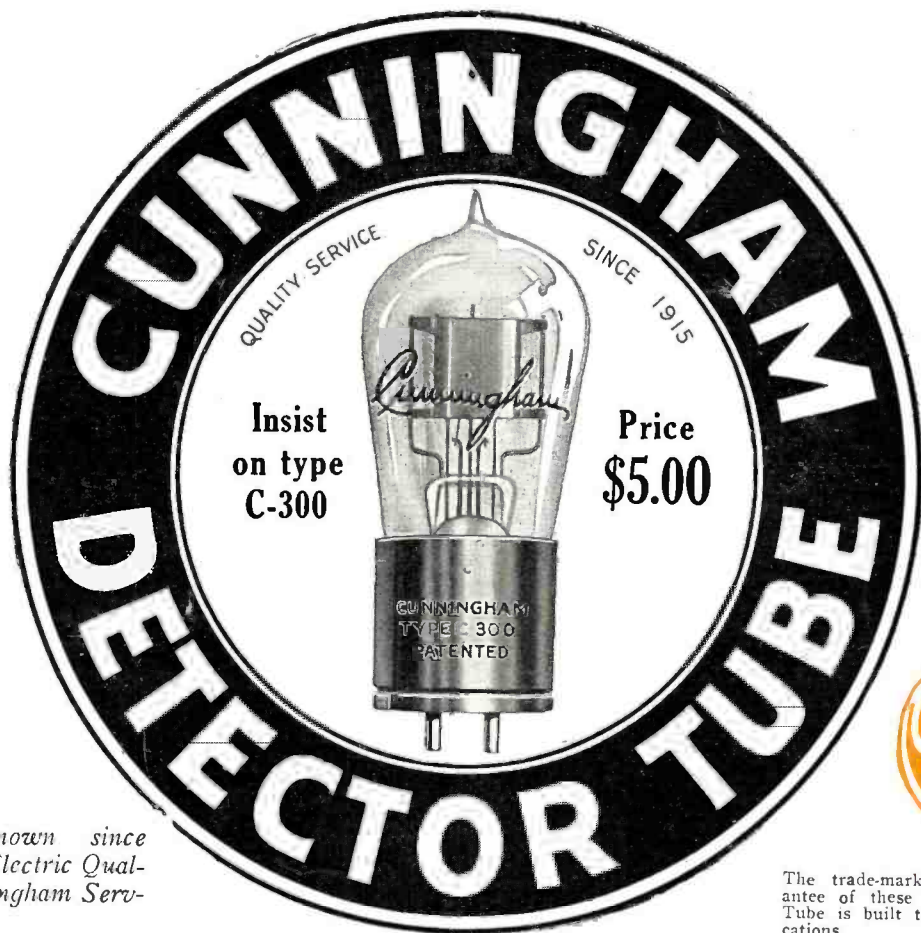

Nationally known since 1915 General Electric Quality Plus Cunningham Service.

The trade-mark GE is the guarantee of these quality tubes. Each Tube is built to most rigid specifications.

Why the Amateur chooses Cunningham Tubes ==

CUNNINGHAM Detector Tube type C-300 functions as a highly sensitive detector of spark radiation, a tone frequency amplifier and an oscillator for regenerative amplification and C.W. reception; also as a radiophone detector and amplifier. It possesses these combination properties to a greater degree with the added advantages of low B battery and quietness in operation.

It possesses almost perfect uniformity in plate voltage, signal audibility and sensitiveness, sustained thruout the operating life, plus all the operating properties of the Ideal Amateur Tube. The mechanical assembly

is entirely by machine, further assisting in uniformity of operation and appearance.

The customary hissing or "bubbling" has been practically eliminated in type C-300, resulting in extreme quietness in operation, and a completely silent telephone receiver in the absence of incoming signals. This permits the reading of faint signals and exact adjustment for maximum sensitiveness.

The amateur realizes that in Cunningham Tubes he has all that five years of service and General Electric Quality can mean to the Radio field.

DEALERS: Standard Packages f.c.b. Cleveland, San Francisco, New York. Broken packages f.o.b. San Francisco.

Trading as Audiotron Mfg. Company
Since 1915

35 MONTGOMERY STREET

SAN FRANCISCO, CAL.

"ATLANTIC RADIO"

AUGUST BULLETIN



U. V. 712
Intervalve Transformer
"Radio Corporation"
\$7.00



U. T. 541
Tube Socket for Radiotron
U. V. 203
\$2.50



P. R. 536
"A" Battery Potentiometer (200 ohms)
"Radio Corporation"
\$2.00



R. C.
KENOTRON
RECTIFIER

U. V. 216, 20 watt, for use with Radiotron U. V. 202, **\$7.50**

U. V. 217, 150 watt, for use with Radiotron U. V. 203, **\$26.50**

SPECIAL

WE HAVE in stock six Type F-1 ACME 500-watt radio transformers which originally sold at \$25.00. This transformer is one of the best ever made, possessing a remarkably high efficiency,—80 to 90%.

Specially Priced at \$19.50

Don't miss this opportunity.

T. A. W. Hot Wire Meters

Just a few left!

This is your opportunity to purchase a reliable hot wire instrument,—O-1, O-2.5,—O-5, ampere ranges,—at the low price of Five Dollars!

Order now:

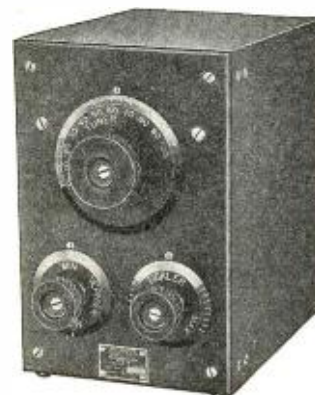

WESTINGHOUSE RADIO EQUIPMENT

Westinghouse Radio Equipment embodies the latest ideas in receiving equipment, providing a most efficient set for telegraph and telephone reception over the amateur and normal ship wave-length ranges.

Type R. A. Short Wave tuner, Style 307189, responds to a wave-length of 180 to 700 meters and is especially selective. Type D. A. detector-amplifier, Style 307190, combines a vacuum tube detector with a two-stage amplifier. Both units are mounted on Micarta panels attached to a polished mahogany cabinet. Simple in design—easy to operate—single-tuning circuit. Highly efficient.

- Type R. A. Tuner.....\$65.00
- Type D. A. Detector Amplifier.. 65.00
- Type R. C. (Combination of above mounted in single cabinet)....125.00

Have You Received Catalogue "E" ?

It completely describes the new DeForest InterPanel equipment. Unusually interesting. *Send on request.*

ATLANTIC RADIO COMPANY, Inc.

88 Broad Street
Boston 9, Mass.

REQUEST "BULLETIN 14"

Branch: 15 Temple St.
Portland, Me.

Please include sufficient postage with all mail orders

RADIO NEWS



CONTENTS

VOL. 3

FOR AUGUST

No. 2

	PAGE		PAGE
Editorial.....By H. Gernsback	93	Radio Digest	110
Radio Helps Fight Forest Fires, By S. R. Winters	94	Improved Circuit for V. T. Supplied with A. C.....By V. H. Brown	111
The Radio Controlled Ship <i>Iowa</i>	95	"A" and "B" Batteries Replaced by Volts A. C.....By Prof. M. Moyer	111
Power Amplification of Audio Frequen- cies.....By H. Metcalf	95	A Method of Measuring the Strength of Wireless Signals, By Hattie Tappenbeck	111
Reporting the Big Scrap by Radiofone, By Pierre Boucheron	97	Filament and Plate Voltage from Volts D. C....By Fred. G. Reifenberg	112
Radio in a Country Town, By Armstrong Perry	98	Fone Reception without Antenna, By Harold S. Potter	112
A New Arc Transmitter, By Charles R. Lentz	99	Who's Who in Radio—General G. Ferrié	113
Radio Apparatus for Amateurs, By G. Y. Allen	100	The Value of a Radio Operator, By Charles J. O'Shea	113
Radio Experiments with Kites, By A. Henry	101	Construction of H. T. Transformers, By H. Winfield Secor	114
Awards of \$100 Portable Radio Prize Contest	101	Labor Saving Table, By Frederick Rumford	116
New Radio Apparatus.....	102	Mechanical Interrupter for D. C. Trans- mitter.....By A. Greenberg	117
Construction of a 1-K.W. Arc Converter, By D. R. Clemons	103	Double Speed Key....By Paul G. Watson	117
Radio at N. Y. Stock Exchange. By Arthur H. Lynch	104	When Romance Meets Up with Science, By Harold Van Riker	118
Broadcasting Radio Market News by the Missouri State Board of Agriculture, By Daniel C. Rogers	105	The Derelict of the Storm, By Charles Reberger	119
Operation of Vacuum Tubes in Parallel, By Jesse Marsten	106	With the Amateur.....	120
Radio Frequency Ammeters, By S. Solomon	107	Junior Course	122
The Clark Radiofone. By Roger R. Smith	108	Junior Constructor	123
A Simple Radiofone Operated on Six Volts.....By Ernest Granger	109	Correspondence from Readers.....	124
		Club Gossip	125
		I-Want-To-Know	126
		Radiofone Goulash	128
		The First National A. R. R. L. Conven- tion and Radio Show.....	128

RADIO NEWS is published on the 25th of each month at 233 Fulton Street, New York. There are 12 numbers per year. Subscription price is \$2.00 a year in U. S. and possessions. Canada and foreign countries, \$2.50 a year. U. S. coin as well as U. S. Stamps accepted (no foreign coins or stamps). Single copies, 20 cents each. A sample copy will be sent gratis on request. Checks and money orders should be drawn to order of EXPERIMENTER PUBLISHING CO., INC. If you should change your address notify us promptly, in order that copies be not mis-carried or lost. No copies sent after expiration.

All communications and contributions to this journal should be ad-dressed to: Editor, RADIO NEWS, 233 Fulton Street, New York. Unaccepted contributions cannot be returned unless full postage has been

Published by EXPERIMENTER PUBLISHING CO., INC.

Publishers of Radio News and Science and Invention

H. GERNSBACK, President

S. GERNSBACK, Treasurer

R. W. DE MOTT, Secretary

included. ALL accepted contributions are paid for on publication. A special rate is paid for novel experiments; good photographs accompanying them are highly desirable.

RADIO NEWS, Monthly. Entered as second-class matter June 6th, 1919, at the Post Office at New York, N. Y., under the Act of March 3, 1897. Title registered U. S. Patent Office. Copyright, 1921, by E. P. Co., Inc., New York. The Experimenter Publishing Co., 233 Fulton Street, N. Y., N. Y. The contents of this magazine are copyrighted and must not be reproduced without giving full credit to the publication.

RADIO NEWS is for sale at all newsstands in the United States and Canada; also at Brentano's, 37 Avenue de l'Opera, Paris.

233 Fulton Street, New York City



Get Into An Uncrowded Profession STUDY CHEMISTRY AT HOME



DR. T. O'CONNOR SLOANE,
A.B., A.M., LL.D., Ph.D.
Noted Instructor, Lecturer and Author. Formerly Treasurer American Chemical Society and a practical chemist with many well known achievements to his credit. Not only has Dr. Sloane taught chemistry for years but he was for many years engaged in commercial chemistry work.

Dr. T. O'Connor Sloane Will Teach You

Never before has the world seen such wonderful opportunities for chemists as exist today. The war has awakened the United States to the need of trained chemists and chemical engineers. Everywhere the demand has sprung up. In factories, mills, laboratories, electrical shops, industrial plants of all kinds, the lack

of trained chemists is acutely felt. In every branch of human endeavor the need for chemists has arisen. No profession offers such alluring opportunities—and the next ten years are going to show the greatest development in this science that this country has ever seen. You be one of the fortunate to get in now.

EARN BIG MONEY Good Chemists Command High Salaries

Many industrial firms pay their chemists as high as \$15,000 a year. Salaries of \$10,000 to \$12,000 a year are very common. Why be satisfied with small pay and hard, thankless work—be your own boss and train yourself in a few short months to have a real profession. The work of the chemist is extremely interesting—if you are fond of experimenting,

if you like exciting and intensely interesting work, take up Chemistry. To the man who is dissatisfied with his present job, to the young man just deciding on his life work, Chemistry holds alluring charms, and countless opportunities. If you want to earn more money, the way is open through Chemistry.

You Can Study Chemistry At Home

Dr. T. O'Connor Sloane will teach you Chemistry by a practical, intensely interesting method. Our home study course written by Dr. Sloane himself is practical, logical and remarkably simple. It is illustrated by so many experiments that are performed right from the start of the course that no one, even with the most common education, will have any trouble in mastering this science. Dr. Sloane teaches you in your own home by the same successful system by which he has already taught thousands in the class room. This method is a short cut gained through years of experience which will save you weeks of time. And, Dr. Sloane personally examines and corrects all examination papers, pointing out your mistakes and correcting them for you. This personal training will be of inestimable value in your future career.

BIG CHEMISTRY OUTFIT Given Absolutely FREE To Every Student



We give to every student absolutely free this valuable chemical outfit. It includes everything you need for the entire course. You couldn't buy so complete an outfit anywhere for one cent less than \$25.00. There are forty-two pieces of laboratory apparatus and supplies and seventeen different chemicals and reagents all enclosed in a fitted heavy wooden box with hinged front and cover. Full particulars about this free outfit are given in our free book "Opportunities for Chemists." Remember we do not charge you one cent for the outfit.

SPECIAL 30 DAY OFFER

Besides giving absolutely free to every student a valuable chemistry outfit, we are making an additional special offer for a short while only. You owe it to yourself to find out about it. Write today for full information and free book "Opportunities for Chemists." Send the coupon right now while it is fresh in your mind. Or just write your name and address on a postal and mail it to us. But whatever you do, act today before this offer is withdrawn.

CHEMICAL INSTITUTE of NEW YORK
Home Extension Division
150 NASSAU ST. NEW YORK CITY

Pay As You Go Along

You don't have to have even the small price of the course to start. You can pay for it in small monthly amounts as you go along—so small that you won't feel them. The cost of the course is very low and our plan of monthly payments places it within the reach of everyone. Write us and let us explain our plan in full—give us the opportunity of showing you how you can qualify for a highly trained technical position without even giving up your present job.

DIPLOMA GIVEN TO EVERY GRADUATE

To every student successfully completing our course we give a handsome diploma all ready for framing. Graduates of our school are qualified to take positions as chemists. With conscientious work ambitious graduates find promotion very rapid.

CHEMICAL
INSTITUTE
OF NEW YORK
Home Extension
Division
150 Nassau Street.
New York City.

Please send me at once without any obligation on my part, your free Book "Opportunities for Chemists," and full particulars about the valuable chemistry outfit given free to every student. Also please tell me about your plan of payment and your special 30 day offer.

NAME

ADDRESS

CITY
R. N. AUG. '21.

"RASCO HAS IT."

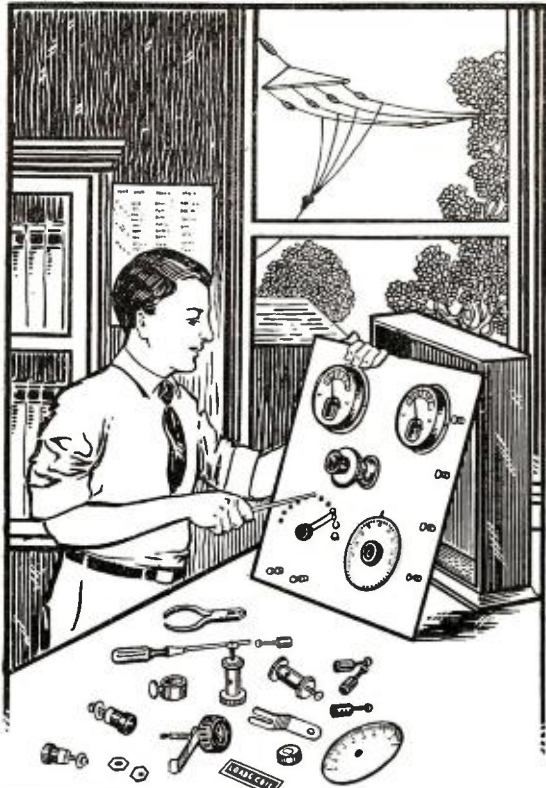

96-98 Park Place
New York.

"RASCO HAS IT"

FOR the past few months we have shown the amateur fraternity what prompt shipments mean. 99% of all orders are shipped within 24 hours and sometimes a good deal sooner. The radio fraternity today understands perfectly that the word "Rasco" is synonymous for service—marvelous service at that. We are showing a few *unsolicited* testimonials on this page, selected at random from hundreds that have reached us, and we only wish that we had sufficient space to print all of the enthusiastic letters. This company is unique in that it sells practically no complete apparatus or instruments—only parts, raw material, etc., are sold. If you are interested in any of the goods listed below, it is vitally necessary that you have our catalog in which you will find all these goods.

WHAT THEY SAY

Gentlemen:

I received my vario-coupler rotor some time ago and it was *even better than I had expected*. The vario-coupler I am using sure brings the stations in Q. S. A.
Wilson Kohli,
351 So. Monroe St.,
Tiffin, Ohio.

Gentlemen:

Enclosed you will find an order for some of your small parts, some of which I have found to be entirely satisfactory. If this order is given the same prompt attention as my first, it will afford me the utmost satisfaction.
W. E. Zingg,
112 Abbott Ave.,
Ocean Grove, N. J.

Gentlemen:

I received the order you sent me in good condition. I certainly do appreciate your promptness in sending out orders. I have dealt with other large

firms, but none of them give as much satisfaction as you do.
Leonard Mayers,
3809Hollybeach Ave.,
Woldwood, N. J.

Gentlemen:

I like your service. Herewith find another order.
W. L. Fick,
3391 Hayward Place,
Denver, Colo.

Gentlemen:

The enclosed order is taken from the catalogue of a friend, who was very enthusiastic about your rapid service.
Milton Weidling,
870 Rockdale Ave.,
Cincinnati, O.

Gentlemen:

Have received two of your "Rasco" Dials promptly, and think there is nothing on the market equal to "Rasco" Dials, considering quality and price.
Stephen S. Peszel,
210 Fourth Ave.,
Schenectady, N. Y.

Gentlemen:

I received your catalog and I am very much pleased with it. I have two of the latest and supposed to be best books on radio and I find that there are only seven of the fifty hook-ups in those books shown in your catalog. Your catalog is small in size, but I have learned my lesson not to buy a book because it is big and nice-looking.
Richard W. Silbert,
3821 N. 13th St.,
Philadelphia, Pa.

Gentlemen:

I received the small shipment of parts from you some days ago and am much pleased with your promptness and care in executing the little order. I enclose another order for an assortment of small parts amounting to \$2.86.
W. S. McGann,
Berry, Demoville & Co.,
Nashville, Tenn.

WE GUARANTEE EVERY ORDER SHIPPED WITHIN 24 HOURS

DEALERS GET OUR SPECIAL PROPOSITION



THE "RASCO" CATALOG A COLOSSAL EVENT

There are many radio catalogs, but the "Rasco" catalog marks a radical change for the simple reason that it **CONTAINS 50 VACUUM TUBE HOOK-UPS**

This is the one and only radio catalog containing such wonderful free information. Complete hook-ups of all important vacuum tube circuits are given in clear diagrams with complete explanation. Just to name a few:—The V.T. as a detector; detector and one-step amplifier; regenerative circuit; De Forest ultraudion; V.T. to receive undamped and spark signals; Armstrong circuits; one step radio frequency amplifier and detector; three stage audio-frequency amplifier; short wave regenerative circuits; V. T. radio telephone; 4-stage radio frequency amplifiers; radio and audio frequency amplifier, inductively coupled amplifier; Armstrong superautodyne; radio frequency amplifier and crystal detector; C.W. transmitters; self-rectifying 2 tube C.V. transmitter; V.T. transmitter with 6 volt battery; radiophone using plate and grid modulation; one tube radio transmitter and receiver; experimental radiophone; radiophone using Colpitt oscillator circuit.

This list is only a partial one. You must positively see this wonderful book to appreciate it. It is made to fit the pocket—has heavy covers to withstand the wear and tear which it is sure to have at your hands because it will be your constant companion.

And Oh yes! Before we forget it. If you are in need of the following, remember "Rasco has it." These are only a few things contained in this catalog. Lugs, Nuts, Dials, Knobs, Washers, Crystals, Litz Wire, Selenium, Cord Tips, Cap Nuts, Tin Foils, Name Plates, Spring Posts, Switch Parts, Metal Ribbon, Carbon Balls, Binding Posts, Switch Points, Switch Levers, Carbon Grains, Metal Pointers, Contact Points, Low Melting Metal, Carbon Diaphragms, Screws, Copper Strip, "Spaghetti," Name Plates, Sliders, Mica, Switches, Resistance Wire, Vario-coupler Rotors, Test Clips, Condenser Plates, Condensers, Antenna Connectors, Threaded Brass Rod, Ground Clamps, Etc., Etc.

The catalog contains 185 illustrations. On account of its great cost, this catalog cannot be distributed free of charge. It will only be mailed upon receipt of **15c in stamps or coin.**

Remember that this business was originated with the sole purpose to cater to the amateur who has small orders. ALL OF OUR ORDERS ARE SMALL and that is why your small order will never be side-tracked by us. One trial order will make you a life customer. You can order from the above illustrations. "We can only stick you once." Try us with a 50c order.



96-98 PARK PLACE, NEW YORK CITY

Factories: Brooklyn, N. Y.—Elkridge, Md.



RASCO SWITCH POINTS
Our switch points are made of brass, nickel plated and polished. The following seven sizes have been found the most popular.

No. 201, 1/4" x 1/2", 1/2" thread.....	each, \$0.03; dozen, \$0.35
No. 202, 1/4" high, 1/4" dia., 1/2" thread.....	each, \$0.03; dozen, \$0.35
No. 203, 1/4" x 1/2", 1/2" thread.....	each, \$0.03; dozen, \$0.35
No. 204, 1/4" dia., 1/2" thick; stem 1/2".....	each, \$0.03; dozen, \$0.40
No. 205, 1/4" dia., 1/2" thick; stem 4-30.....	each, \$0.03 1/2; dozen, \$0.40
No. 206, 1/4" dia., 1/2" thick; stem 4-30.....	each, \$0.03 1/2; dozen, \$0.40
No. 207, 1/4" dia., 1/2" thick; stem 4-30.....	each, \$0.03 1/2; dozen, \$0.40

Just a Sample Page from our Catalog. Order from this page if you wish. All goods sent prepaid.



RADIO NEWS

H. GERNSBACK—Editor
ROBERT E. LACAULT—Associate Editor



Vol. 3

AUGUST, 1921

No. 2

A COLD-CATHODE VACUUM TUBE

WE have often stated in these columns that present vacuum tubes have not reached their ultimate state of perfection, nor do we think that they will ever reach that state.

While the present audion type is a marvelous piece of apparatus that has done more than anything else to revolutionize radio, still even the most enthusiastic user has often felt that in many respects the audion is a nuisance. In the first place, the filament has a habit of burning out at a most unpropitious time. Then again, in order to light up this very troublesome filament, we require the use of a heating battery as well as a rheostat. All of this tends to cut down the general usefulness of the tube, particularly when it is desired to use it for portable sets where weight and space are at a premium.

Suppose we had a vacuum tube without any heating element or filament. It would certainly be welcomed as one of the greatest boons to radio, and this is exactly what is being developed now.

For several years past, Dr. Julius E. Lilienfeld, Professor of Physics of the University of Leipzig, has made certain researches that bid well to revolutionize not only our vacuum tubes but our preconceived ideas as to ionic bombardments that take place inside of vacuum tubes.

Dr. Lilienfeld who at present is in New York has already given a public demonstration of his new tube before the Department of Physics of Columbia University as well as before the New York Roentgen Society. For be it known that the new principle of this tube does not only confine itself to audions. The principle was primarily evolved, and is now practically used in a new X-ray tube by Dr. Lilienfeld. There is no secret and no hokus-pokus about the new invention. As a matter of fact every radio man and every electrician will ask himself at once why it has not been realized before. It is the old story of Columbus and the egg.

In a few words, the new tube as used for radio work consists of a plate which may be of Tungsten, or any other metal to which is opposed a somewhat pointed electrode, and

that is all. These two electrodes are enclosed in the ordinary type of bulb, but it should be stated here that the vacuum in these bulbs must be of an extraordinarily high degree. An ordinary form of evacuation will not do.

Under these conditions a pure electronic flow will take place between the metallic point and the metallic plate even at potentials of an order of magnitude as low as only 100 volts.

In an interview with Dr. Lilienfeld, the writer asked him many interesting questions, but due to the patent situation, it is impossible at the present time to disclose further information of the tube. The writer may say, however, that Dr. Lilienfeld stated that any metals can be used either for anode or cathode or both, and that the metals themselves do not seem to make any material difference. It is not possible at the present time to disclose the circuits that are used with this tube, as far as radio work is concerned, but Dr. Lilienfeld has promised to write an article for RADIO NEWS in the near future regarding his new invention. Dr. Lilienfeld recently demonstrated at Columbia University his new X-ray tube which consists of a target of Tungsten opposed to which is a metallic point. The distance between the two electrodes is about 1/5 of an inch.

This tube worked remarkably well on a 5 K.W. Transformer and its glass wall remained cold for over one-half hour under steady load where some of the known tubes become fearfully hot in less than two minutes. In connection with the pointed electrode, it may be mentioned as interesting, that this point does not wear away whatsoever as might be thought. It retains its shape indefinitely. We have here to do with a pure, *natural* electronic stream given off by the cathode which remains cool and which does not heat up. This is a phenomenon which a year ago would have been thought impossible. We predict great things for this new tube as far as radio is concerned, for, not only can it be used as an audion but as an amplifier and a generator of C. W. as well.

H. GERNSBACK.

IMPORTANT TO NEWSSTAND READERS:

In order to eliminate all waste and unsold copies, it has become necessary to supply newsdealers only with a sufficient amount of copies for which they have actual orders. Please note that your newsdealer will be glad to reserve a copy for you every month. This costs you nothing and you

will be assured of your copies. Hand your newsdealer a slip of paper on which write your name and address with a request to reserve a monthly copy of RADIO NEWS for you. This will be the only way to assure you of your copy hereafter.

THE PUBLISHERS.

Radio Helps Fight Forest Fires

By S. R. WINTERS



On the left, the fotograf shows the complete radiofone set used in detecting and reporting fires occurring in the forests. Thanks to these apparatus the fire-fighting squads may promptly be notified and directed right to the fire.

FIRES originating in the National forests exact a toll ranging from \$25,000,000 to \$40,000,000 annually. Detection and suppression of these conflagrations, altho largely preventable by organized forces, are the available means for arresting their ravaging effects. Statistics in possession of the United States Forest Service indicate a direct relationship between the dispatch of a fire-fighting crew to the scene of the blaze and its resultant levy on woodland resources. Differently expresst, any system of detection is well-nigh valueless, unless information of discovery is speedily communicated to active suppression forces.

The airplane is a prompt detection agency, while radio equipment affords a hurry-up method of conveying the news of an outbreak to the fire-fighting crew. Aerial patrol of the vast woodlands of Uncle Sam is ineffectual in the absence of a wireless outfit as a companion instrument. Consequently, a cooperative agreement has been negotiated between the Forest Service and the Air Service of the United States Army whereby air-going machines and wireless communication become standard fire-suppression agencies. Congress has appropriated \$50,000 in projection of the service during the current year, and 12 wireless outfits have been borrowed from the Navy Department.

Montana, California and Idaho will constitute the base of operations, experimental efforts having heretofore been conducted in Montana and California. Thunder Mountain, a vast area in excess of 1,000,000 acres in southern Idaho, recently acquired by the Federal government, has been selected by reason of the rigid requirements involved in the successful operation of the airplane and wireless telephone. This territory is rugged and inaccessible, and in the execution of aerial patrol its efficiency as a fire-combatting agency can be scientifically determined. Forest conflagrations are not partial to location with respect to their origin—not unlikely the outbreak occurring in remote places, rarely invaded by man. Soaring above the topographical difficulties the air-exploring vehicle, fitted with radio equipment, will be enabled to patrol the vast wilderness, detect potential blazes, and promptly report their locations by harnessed electric waves to forest-ranger stations. The dispatch of an organized crew to the desig-



The upper fotograf shows a portable station installed in a tent. On the right is a view of one of the fixt stations installed by the U. S. Forest Service. Note the aerial fixt to the pole.

(Fotos by courtesy of the U. S. Forest Service.)



nated outbreaks will result in quelling the conflagration a-borning.

The original cooperative plan of the Forest Air Service contemplates a comprehensive system of radio communication, the fruition of which is of future realization. Every airplane would be equipit with a wireless outfit, with a liberal distribution of ground stations capable of the transmission of messages irrespective of the location of the machine. The planes are to be supplied with SCR 68 and 67 radio sets, the ground equipment being SCR 74. The umbrella type of antenna is suggested. The standard requirements as outlined are: For each wireless station to be installed in conjunction with fire-patrol service there shall be maintained one small hut 8' x 10' in dimensions, or a room of equal size in a house. Ample clearance around the hut or house is to be provided to permit the erection of a radio mast, with an unobstructed space of 100' radius from the base of the mast. Provisions are specific in including facilities for charging batteries, and for board and lodging of two wireless operators.

Responsibility for the equipment and maintenance of the service is jointly shared by the Forest Service, Air Service, and Signal Corps. The latter is to furnish equipment and personnel for ground stations, supplied with one-way sets. The Forest Service is to provide the housing facilities, while the Air Service is responsible for wireless fixtures installed on airplanes. The communication of discoveries of fires to the local telephone exchange from landing fields and radio stations, is a duty devolving on the guardian of the National forests, namely, the Forest Service. From July 1 to September 30, 1920, the airplane, as fire-detection vehicle, revealed the presence of 772 blazes, radio communication being the connecting link between the revealing agent and the active fire-fighting crew. Here is a concrete example taken from a report transmitted from a forest ranger in California to the Washington office of the Forest Service:

"On Mill Creek fire of the Lassen the most intensive use of the airplane in conjunction with fire suppression was developit. This fire, which covered about 3,000 acres in a very inaccessible territory, created a very severe problem in patrol due to the rugged topograpy and length of the fire line. A radio-receiving set, with an operator, was dispatched to the central fire camp and an airplane was assigned for daily patrol on this fire. The observations were received at the ground station and were immediately available to the fire chief who dispatched his patrol forces as well as sup-

(Continued on page 144)

The Radio Controlled Ship "Iowa"

AMONG the bombing tests conducted jointly by the Army and Navy air forces the latter part of June and the first part of July, the most spectacular and interesting from the public viewpoint was the search problem and accuracy of bombing test on the radio controlled *Iowa* on June 28.

In one respect war conditions were accurately simulated in this problem, for the old *Iowa*, under the control of a distant ship, maneuvered as an enemy ship, just as tho she had a crew aboard, except that her speed was somewhat reduced. Starting at a point somewhere between 50 and 100 miles at sea off the Virginia Capes, the *Iowa* steamed toward shore while the planes from shore, starting at the same hour, flew out to locate her. When this was accomplished, the bombing with dummy bombs began.

For this operation the Army used only the seven seaplanes it obtained from the Navy and four airships, all of its land planes having been withdrawn from this test. The Navy had four of the "NC" type of flying boats and 12 "F-5-Ls" in the search problem and four Martin bombers, land planes, aiding in the accuracy of bombing tests. The Navy dirigible took part in the search problem.

In order to use the *Iowa* for a moving target, she was fitted out with special apparatus that enabled her to be controlled by wireless from a ship at a distance. Some extensive changes in the *Iowa's* power plant were necessary in order to have the propelling machinery capable of running for a considerable time without attention. The boilers were changed to burn fuel oil instead of coal, and automatic devices for feeding the fuel to the burners and supplying water for the boiler were provided.

The apparatus for controlling the ship consisted of a standard radio transmitter aboard the controlling ship, a receiving aerial on the *Iowa* with special radio receivers, amplifiers, relays, etc., for converting the radio signals into a form so that they would operate the electrical devices which control the steering gear and the throttle of the main engines.

The officer in charge of sending

On the right is a picture of the battle-ship "Iowa," which was used for a bombing test from airplanes. The ship is entirely controlled by radio.

(Official photo of U. S. Navy.)

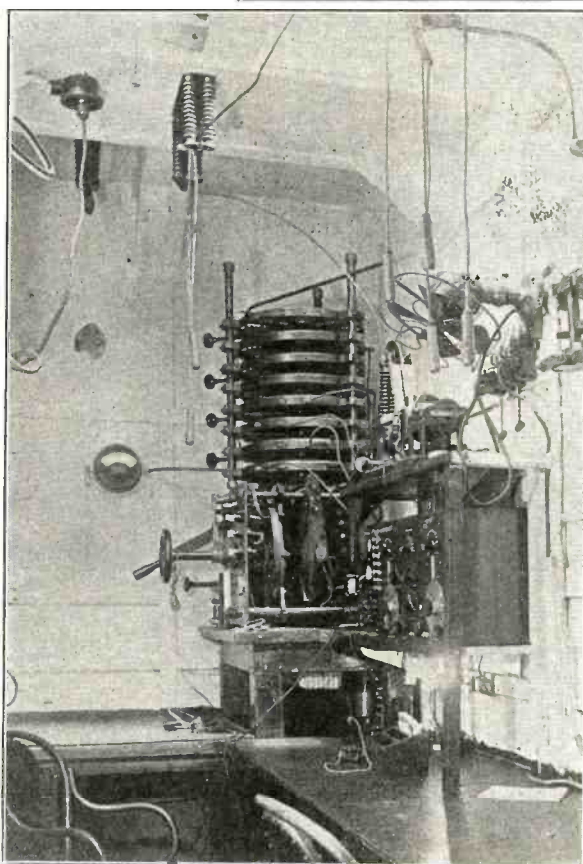
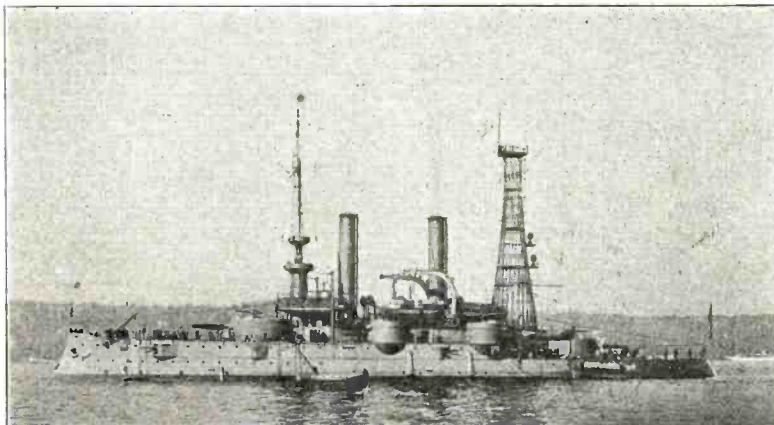

Above is a View of the Radio Room Aboard the "Iowa." On the Left is an Airplane View of the Ship. Note the White Targets on the Deck.

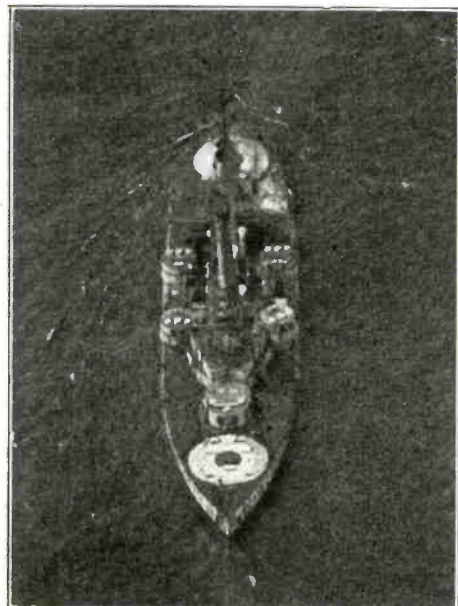

out the radio signals from the control ship had absolute control of the starting of the *Iowa*, steering her in any direction and stopping her when desired. The various operations which took place were as follows:

When everything on board the *Iowa* was ready, the main engines were started up and were left running very slowly. The ship was then abandoned and the officer aboard the controlling ship had control of the *Iowa*. The first radio signal sent out was intercepted by the aerial on the *Iowa* and received by the radio receiver located well below deck.

This signal was then amplified by means of special vacuum tube amplifiers and was made to operate a very sensitive relay or switch, which in turn operated a larger relay. This large relay closed an electrical circuit which operated an electrically controlled pneumatic valve. When this valve opened, it admitted compressed air to the

throttle control of the main engines, which caused the throttle to open and bring the ship up to full speed.

The above mentioned relay also operated a device called a commutator, which is a special switch having control of the steering mechanism.

The steering gear consisted of a standard steam engine-driven rudder gear, the throttle valve of the engine being geared to a small electric motor. The commutator was connected to the control panel of this motor and was thus able to operate the electric motor, which in turn caused the steam engine to drive the rudder to either starboard or port, as desired.

A very novel feature of this installation was the automatic steering, which was made possible with the aid of a gyro-compass. The compass was electrically connected to the control panel of the electric motor on the steering gear, so that the ship could be made to hold any course, and the gyro-compass immediately operated the steering gear to return the ship to her course. The officer sending the control signals could steer the *Iowa* to either starboard or port, or could put the gyro-compass in control and hold a steady course.

The commutator might be considered the mechanical brains of the *Iowa*; it received the radio signals and interpreted them, passing them on directly to the electric motor controlling the steering engines, if the order was either starboard or port, or else giving the gyro-compass control, if that was the order.

If the officer in control desired to stop the *Iowa*, he would send a long signal of about ten seconds' duration. This would operate a special relay which would open the circuit on an electrically controlled pneumatic valve, which would shut off the various fuel oil and feed water pumps, thus shutting down the power plant and stopping the ship.

A special safety device was provided in the form of a time clock, which automatically shuts everything down in case the radio receiving apparatus should become inoperative, or in case no control signals were received after a certain lapse of time.

The radio receiving instruments and amplifiers were of Navy type. The special relays for converting the radio signal to a form which could be made to control the electrical devices, were furnished by John Hays Hammond, Jr. The electrically operated pneumatic valves and their controlling relays for controlling the throttle

(Continued on page 160)

Power Amplification of Audio Frequencies

A Super-Power Amplifier—Output 40 Amperes

By HERBERT E. METCALF*

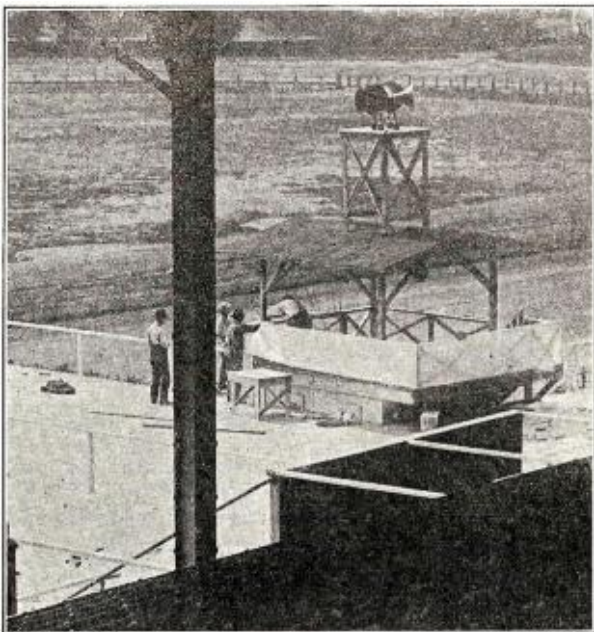

In This Photograph May be Seen Four Loud Talkers Installed on a Sporting Field to Give the Results to a Large Crowd. This "Battery" of Telemegafones Increases the Voice to a Tremendous Volume.

Perhaps also it was the great use of audio amplifiers in the amplification of speech that led us along that line.

To begin with, it is necessary to get the idea of power, in reference to the amount of sound produced. We all know what a *v e r y* infinitesimal amount of power it takes to produce an audible signal in a pair of high-resistance receivers, and we also know that this power must be greatly increased in order that the same signal may be "heard all over the room," with any type of receiver. In order that signals might be thus heard the demand for radio two and three stage amplifiers has developed until today all radio men are familiar with this type of apparatus.

Two and three stage

radio amplifiers, as we know them, have two or three amplifying tubes placed in cascade circuit of some type, usually transformer coupled. This gives us amplification up to a certain point of loudness, and then the output limitations of the tube do not permit further amplification. We know, too, that once this point is reached, no further amplification can be obtained in any manner by adding amplifiers of new stages using the same tubes or transformers. Perhaps the output of these tubes at the very most is only a few milliamperes—say 10,

according of course to the design and tube used.

In a discussion of this sort one always feels the lack of **UNIT OF SOUND**. Such a unit is not available at the present time and any unit that depends on the ability of the human ear to judge the volume, is imperfect, for no two human ears will judge the same. Therefore we must speak in watts, amperes and volts, passing in the circuit thru the voice reproducer or receiver. In order that we may get squared away in some manner, we will take the Magnavox electrodynamic loud-speaker or telemegafone for a standard loud-speaking unit, as it was with this type of receiver that the experiments were performed, and which formed the basis of the Commercial installations.

No lengthy description of the electrodynamic receiver will be given here, as it is already well known, consisting of a coil firmly attached to a diaphragm, floating in a strong magnetic field, being acted on by the voice currents (Fig. 7). In early experiments, with receiver coil wound to 20 ohms, connected in circuit with a four-button transmitter thru the proper induction coil delivered between 150 and 200 milliamperes thru the telemegafone coil, when talking into the transmitter in a firm tone of voice, or playing the average fonograf record with the transmitter attached to the tone-arm.

It must be noted that in all the above and the following experiments, nothing is flowing in the telemegafone circuit except actual voice currents, due to the fact that an induction coil is always used. The current used may be measured by a hot wire ammeter or a thermogalvanometer, inserted in series with the little coil and the secondary of the induction coil.

150-200 milliamperes in this circuit produces a sound in the telemegafone much louder than a man can talk, or a fonograf play, without any true amplifier (such as a vacuum tube). Fonograf

(Continued on page 132)



This is a Power Amplifier Used to Boost up the Current of a Microfone Circuit in Order to Operate a Telemegafone at Maximum Efficiency.

WITH the increase of modern radio telephone popularity, it has become more and more evident that something beyond just hearing music or the voice in a pair of headphones is being demanded. Radio dances are being held, and radiofone music amplified to an enormous degree.

Again, modern public speaking has made demands upon loud-speaking apparatus, until to-day no assemblage of people is too great for the human-amplified voice to cover.

As early as 1915 the first electrodynamic loud speaker, or Magnavox Telemegafone, was used to talk to a crowd of 50,000, and since that time it has been used in practically every public gathering where a crowd of 10,000 or more has congregated. The reason for the use of the electrodynamic receiver in these cases is due to the inherent characteristics of its patented design—that of reproducing sound in direct proportion to the amount of input. Naturally engineers turned to the audion amplifier to supply increased input, and now for the first time the results of these experiments are to be made public. The results are well known by all, but the actual engineering principles back of the enormous magnification of sound have been more or less a mystery.

As the same principles apply to the amplification of radio signals after they have been rectified, the following discussion may be applied to all audio-frequency amplification, including the human voice, radio telegraf signals, music of all kinds, and radio telephone music and voice.

In the amplification of radio signals, this country has not progressed along the same lines as England. The latter has developed the radio frequency resistance amplifier, and rarely uses over three stages of audio-frequency amplification, while we have been more taken up with the amplification of radio signals after they are rectified, and this has led us into somewhat different channels of that.

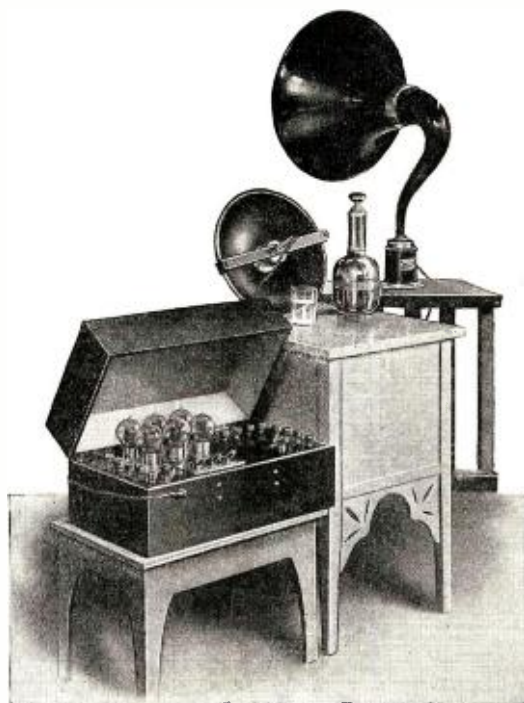

This Complete Outfit is Used When a Lecturer or Speaker Addresses a Large Crowd, Especially Outdoors. On the Table May be Seen the Bowl-type Microfone and on the Left the Power Amplifier.

*Formerly Radio Officer U. S. Army Air Service.

Reporting the Big Scrap by Radiofone

By PIERRE BOUCHERON

WHILE referee Harry Ertle counted "one, two, three, four, five, six, seven, eight, nine," and finally the fateful "ten," more than 300,000 "ear witnesses" to the big Dempsey-Carpentier fight were breathlessly "listening-in" and hearing the same words by means of their Radio telephone receiving apparatus. These amateur and professional Radio men were located on land and sea at points far removed from the fight arena. In fact, practically every Radio fan in New Jersey, New York, Pennsylvania and other surrounding States was at hand, as well as nearby friends and neighbors, to hear for the first time the returns of an international sporting event by Radio telephone. Then, too, many stations caught the words and in turn relayed the news farther on to more remote points so that the event was heard thruout the United States from the Atlantic to the Pacific coast in the same unique manner. In addition to the amateurs, hundreds of vessels, near and far from New York harbor, had also "tuned in" and passengers and crew alike heard, not meaningless telegraphic signals, but the actual voice of the Radiofone reporter announcing in the same manner as an eye witness would, the essential features of what was going on in the arena.

This scientific feat which marks a new era for Radio telephony was made possible by the combined efforts of the General Elec-

tric Company and the Radio Corporation of America; the first organization, by furnishing the necessary apparatus, and the second by installing and placing the set in operation and performing the multitude of details which this feat involved to make it a success.

In recent years much has been said concerning the wonders of wireless, but the "stunts" mentioned were in most instances isolated cases which did not particularly benefit any great number of people or mean much to the average person. This latest

project, however, was singularly unique in that it gave out timely news to thousands of Americans without the thot of mercenary remuneration. It is probably the greatest achievement of Radiofone broadcasting up to date.

The project was primarily devised to help the Committee for Devastated France as well as our own Navy League. Wireless amateurs within a radius of 200 miles were asked to help by offering their services in erecting suitable receiving equipment at local theatres, halls, sporting clubs, auditoriums, Elk, Masonic and K. C. Club houses and other public gathering places; nearly 100 in all. A nominal admission fee was charged on the day of the fight and the voice

bulletins sent by the big station at Hoboken were heard by the crowds almost simultaneously with the time of their actual happening at Jersey City. The returns from these sources were turned over to the two organizations mentioned above.

THE APPARATUS

The central Radio telephone transmitter was located at the Delaware, Lackawanna and Western Railway station, Hoboken, N. J., utilizing the great steel tower which this railroad used some years ago in its train-dispatching-by-wireless system. The apparatus consisted of a 1,500-watt Radiofone transmitter employing six 250-watt Radiotron vacuum tubes.

A special motor-generator was erected near the set which furnisht a potential of 2,000 volts necessary for the plate excitation of these tubes. The filaments of the tubes were heated by means of a separate low voltage winding arranged on the machine. The vacuum tubes and all other auxiliaries are contained in one unit as shown in the accompanying illustration, the panel of which contains all necessary switches for power control and wave-lengths.

THE ANTENNA

The antenna, which is clearly shown in the second illustration, was stretched between the skeleton steel Radio tower shown and the clock tower of the D. L. & W. ter. (Continued on page 156)



Inside View of the Radio Station Installed in Hoboken, N. J. for the Broadcasting of the Results of the Dempsey-Carpentier Fight. In the Background May Be Seen the 3 K.W. Radiofone Set With the Operator Speaking Into the Microfone.

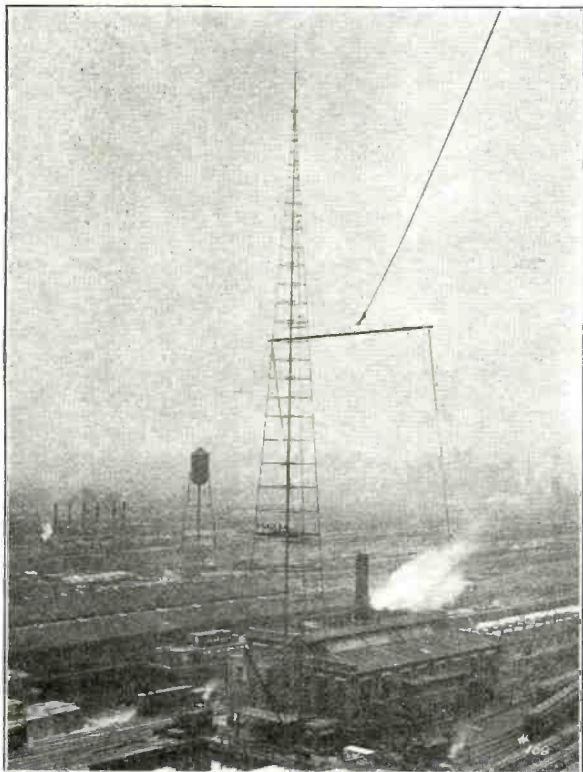

The Steel Tower of the D. L. & W. R. R. Station to Which Was Fixt the Aerial of the Transmitter. Note the Lead in on the Left of the Tower.

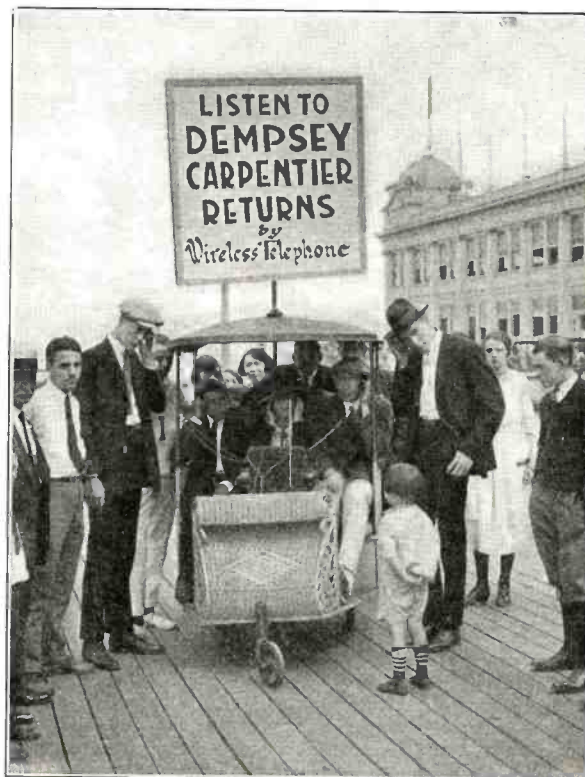

At Asbury Park, N. J., the Reports of the Fight Could be Heard by Several Persons While Comfortably Installed in the Roller Chairs Equipt with Receivers.

Radio in a Country Town

By ARMSTRONG PERRY

ON the first of May I took my wireless outfit under my arm and started for the country to see if radio would interest small town folks. I picked the town of Canton, Penn., as my *terrain*.

It is a typically American rural town, the center of a farming section. Most of the villagers have farmed more or less, and a garden plot or pen of chickens keeps each family in intimate contact with the soil. On the other hand, Canton is not a "rube" town. It is wide-awake and up-to-date, and keeps in touch with all the modern movements so far as possible. It has an efficient public library, a visiting nurse, a Village Improvement Society and an athletic field. Its 2,500 people take an intelligent interest in science and invention.

I want you to get this background, because there are 26 Cantons in the United States, and 35,000 other towns of equal possibilities just waiting for someone to tell them about radio.

The morning after my arrival I went out to put up an aerial. There was no very high place to attach it to, but by crawling up on a shed roof and anchoring one end to the gable of the barn, swinging an elbow from an apple tree by means of a cord long enough to clear the branches, and attaching the other end at the peak of the house roof I constructed an antenna that gave promise of bringing in something.

Before it was finished, I was approached by a Boy Scout in the shy but persistent manner of the country. A few well-aimed questions brot down from the top of my ladder the information that he wanted. After assisting with the lead-ins and battery connections, he took the fones at my suggestion and his eyes glowed with suppressed excitement as he heard NSS's silvery tones come purling in. After that it was only a matter of minutes before he was multiplied by three, and then the stampede began.

I wish that all those men who sit at desks in cities, worrying over the problem of promoting interest in radio and increasing sales could have seen what happened during the next four weeks. It would help them to realize that all they need to do to interest folks in radio is to show them a station that is working, explain how it works and let them hear some signals. In all that town I found just one man who had ever heard a radio signal before. They were all eager to see and hear and know. They came for miles. It was news to them that the town could get the weather forecasts, the latest market reports on farm produce, official news service from New York and Washington, correct time from the Naval Observatory at Arlington. The more they thot about it, the more they wanted it as a regular thing.

The time tick from Arlington seemed to interest them most of all. That was something they could all understand. The jewelers who came to get the time said that their only means of correcting their clocks and watches was to make a trip to the railroad station and interview the telegraf operator. That is a distinct disadvantage, for country folks buy the best watches they can get and are as fussy about the performance of their chronometers as a train dispatcher, even when a glance at the sun is all they

need for practical purposes in their daily routine. A jeweler who cannot guarantee his time is apt to lose trade. It was worth the trip just to see the oldest inhabitant catch the tick and point proudly to the fact that his ancient silver timepiece, after 40 years of service, could be used to set the Naval Observatory clock by, if the seventy-fifth meridian should be knocked out of true by some careless airman.

A miss of 17, who made the front porch of the house across the street easy to look at, came over to listen. (I did the other two things advised by the sign at the railroad crossing.) "We ought to have you lecture at our high school," she said after a while.

"Just ask me," I suggested.

The principal did the asking and made room for me in the busy schedule just preceding the final examinations. I explained as much as I could about radio in 30 minutes and then stayed long enough for every pupil to hear the signals as they whistled in from the high-power arc stations thru the audion receiver which I had set up.

Afterwards I learned that some of the little sub-debs had faked me. The antenna wire was laid across the floor, as there was not time enough to erect a regular aerial and the signals, tho readable, were not loud. I asked each one who took the 'fones if

and my accuracy, but the next day's papers proved our case and the enemy was captured. Thereafter he fed out of the Scout's hand and asked for more, while news by radio became as undeniable as anything that was printed in the local paper.

Not long after I started my campaign of propaganda for radio, I detected expressions of anxiety on the faces of a lot of parents, some of whom had been my schoolmates in the red brick schoolhouse. It required no unusual intuition to associate this with the talk that was going around among the boys about vacuum tubes being \$5 and \$6 apiece, storage batteries \$15 to \$20 apiece, and cabinet sets like mine costing several hundred.

Now we city men, even tho we may have grown up in the country, quickly forget how big a dollar looks back there in the small town. When associated with a boy's hobby, which as all parents know is apt to be short-lived. The weight which parents attach to that ounce of silver or its paper equivalent is not due to miserliness, as so often misrepresented, but to the comparative inactivity of coin of the realm in country districts. A city man pays five dollars for twenty cents' worth of food, gives the waiter a dollar to send out of the country and makes his customers pay for it all. The small town man gets a dollar's worth of grub out of a cent's worth of seed plus a

little elbow grease, gives half of it to the neighbors, has three square meals out of the rest and does not disturb the small change in the pocket of his jeans all day.

The city man, used to doing everything with money, faces an expenditure of \$100 on a son's hobby without having to take digitalis to restore his heart action, but \$100 in cold cash represents to many a country man a year's savings or more. If he is going to be drawn into spending that much money he prefers to buy a farm or a Liberty Bond or something else that will grow while he sleeps.

I hastened to put the brakes on the runaway dreams of the budding Jack Binnses. I pointed out that it was folly to buy expensive outfits before they could copy the signals that would be brot in. I advised pooling of funds and purchases. If I had been a salesman of the kind that visits a town once and cleans up, I believe I could have sold a thousand dollars' worth of regenerative sets, amplifiers and loud speakers and left the town dead for a decade so far as radio is concerned. Not being a salesman of any kind I did not sell anything. I merely started to work out with interested citizens a plan whereby the town can establish in the immediate future at least one reliable receiving station at which a competent operator will stand watch daily to pick up important broadcasts such as the reports from the United States Bureau of Markets, the Navy time signals and weather forecasts, the New York Police Department alarms for stolen automobiles, the amateur schedule from the Navy Amateur Bureau, and the Navy press.

Included in the plan is a transmitting outfit of sufficient range to reach every boy in the township who has the "pep" to build for himself a receiving outfit.

This plan requires intelligent supervision. This has been volunteered by a Scoutmas-

(Continued on page 164)

WE commend the entire radio fraternity including our radio interests at large to read Mr. Perry's article thoughtfully. It seems that right along we have been too close to the grindstone with our noses, and have never seen how large a thing this radio game of ours can be made. Mr. Perry takes a lofty view of radio in general and shows us how to put 35,000 U. S. towns on the map as far as radio is concerned. There are thousands of small cities and villages all over the country that have never seen the sight of an aerial. All this territory is virgin field for our radio interests and presents a gold mine to them if they go about it in the right way.—Editor.

he or she could hear the sounds distinctly. Each girl, with an ear piece held lightly against a "cootie garage" as they call them things up thar, solemnly assured me that everything was QSA and perfectly wonderful, but two or three of them told afterward that they didn't hear a thing. But then even Audrey Munson wouldn't show her ears. Mercy, no! A very large majority of both boys and girls heard the signals produced by the radio waves and acquired a reasonably correct conception of the method by which those waves are transmitted and pickt up. A lot of the boys are already at work building receiving sets.

As none of those who listened in during the month could understand what they heard—the Boy Scouts knew the general service code, of course, but they could not copy at commercial speed—I needed to prove to them that much of the traffic was of value to them. My most valuable publicity assistant was the Scout who saw me first. Sometimes he stayed late enough to get the day's scores of the big baseball leagues. Armed with this information he would circulate where gossip was thickest and share his knowledge.

"What!" said a sporting "wiseacre" the first night, "Cincis beat the Giants ten to nothing? Forget it! You're all wrong."

It was a severe test of the Scout's faith

A New Arc Transmitter

By CHARLES R. LEUTZ*

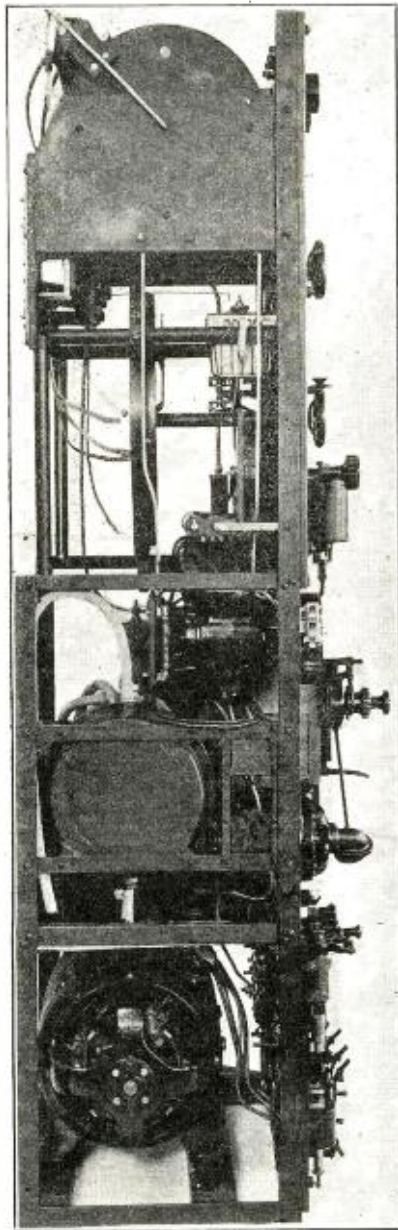

Left Side View of the 5-K.W. Arc Set. At the Bottom May Be Seen the Motor Generator.

TO the layman an arc transmitter seems extremely complicated, while actually it is probably the most simple form of apparatus for radio transmission, and has many advantageous features over the spark and power tube transmitters.

The spark method of transmission will rapidly be replaced by apparatus emitting continuous waves, as the latter method has two distinct advantages, first, sharp tuning at the receiving end, and second, the apparent ability of continuous waves to travel further with a given antenna input compared to damped oscillations.

An arc transmitter simply consists of an electric arc, the two terminals of which are connected to the antenna and ground of the station. Of course certain associated apparatus is necessary to maintain the arc at whatever powers are desired and to emit energy at frequencies depending upon the transmitting wave-lengths required.

This particular transmitter, a 5-k.w. (arc input) unit, was designed primarily for installation on shipboard and occupies a mini-

mum of space, approximately 6' 6" x 24" x 24", including everything but the cooling tank and lightning switch.

Fig. 1 shows a left-side view and Fig. 2 shows a three-quarter front view. All the apparatus is contained within this angle iron frame, the upper portion is confined to radio frequency equipment as far as practical, and the lower section is devoted to the direct current controls.

At the extreme top of the panel are three Weston meters, an 0 to 500 voltmeter and an 0 to 30 ammeter to read the power input to the arc. A radio frequency 0 to 30 ammeter is also provided to read the antenna current or the current flowing in the absorbing circuit, depending upon the position of the relay key. Under the meter is the wave-length control switch, allowing transmission on either 600, 1,800, 2,100 or 2,400 meters. Provision to transmit on 300 meters is also possible, by using a stabilizing circuit in shunt to the arc proper. Continuous wave transmission on 300 meters is not all that can be desired, but when modulated with the special modulating device, a steady note with slight damping is emitted and readily copied with a crystal or non-oscillating audion.

This wave-length control switch controls two inductances, a main inductance and a compensating inductance consisting of the conventional spiral of strip copper. Inasmuch as Litzendraht is composed of a large number of small copper wires, all insulated from each other, it is apparent that a tap cannot be taken at random. Furthermore, considering that the emitted wave-length of the transmitter is determined, in addition to the antenna constants, by the amount of inductance in series with the antenna, it is necessary to adjust this series inductance very accurately. This is accomplished by taking as many Litzendraht taps as possible, for example eight sections of Litzendraht on the main loading coil with an average ship antenna, would give a wave-length of 2,050 meters, and the desired wave-length was 2,100 meters. The additional inductance necessary to lower the frequency to 2,100 meters can then be adjusted, with the transmitter in operation, with the control wheel directly under the wave-length control wheel. A permanent clip with a flexible lead can then replace the revolving contact and that adjustable contact used for some other wave-length adjustment, and the four wave-lengths calibrated in that manner.

To the right of the wave-length control switch is the low-power switch, this switch simply short circuiting a non-inductive resistance, which is in series with the antenna, consequently reducing the antenna current, and transmitting range. Reduced power is also obtained by reducing the arc input, but the first mentioned method is quicker.

To the right of the other control wheel, the relay key's auxiliary handle protrudes thru the panel. This relay is remotely controlled, electro-magnetically from the operating table, but in case the solenoids fail, the key can be operated by hand. This relay key provides one of the advantageous features of this transmitter, being so arranged that no "compensating wave" is emitted. In other words, when the operator is not transmitting, the arc is still ignited, but no energy is transferred to the antenna. This is accomplished by the relay key automatically switching the antenna to an absorbing circuit which has approximately the same constants as the antenna. This circuit consists of a high tension condenser, two standard .004 M.F. sections in parallel,

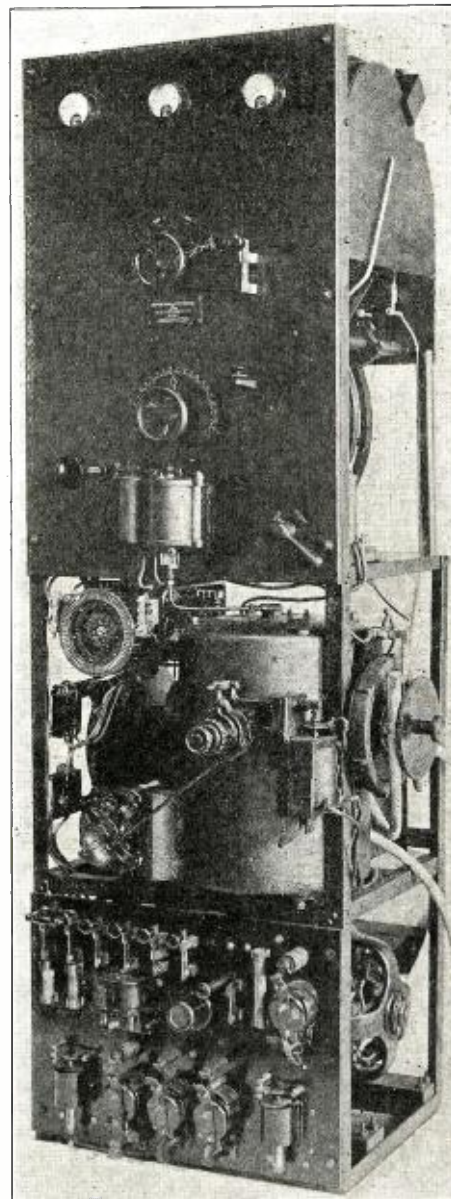

This New Ship-type of Arc Set Embodies Several Novel Features. Efficiency and Compactness are its Keynotes.

a fixed resistor, and an adjustable iron plate resistor. The handle for the adjustable resistor is to the left of the panel and on the end of this shaft is an iron plate, the distance from the iron plate to a bank wound inductance coil being variable. It is, of course, apparent that the closer this iron plate is to the inductance, the more resistance the inductance will have. This circuit must be designed to dissipate the same amount of energy as the antenna handles and in some cases more.

The alcohol reservoir and hydro-carbon magnetic needle valve are located on the lower part of the high-frequency panel. This device also has a level glass which shows the quantity of alcohol in the reservoir and a sight feed glass so that the rate of flow of alcohol to the arc chamber can be noted. For the readers who are not familiar with arc transmitters, it may be well to mention that the alcohol is fed into the chamber to enable the arc to handle more current with a given arc distance and to maintain oscillations with a higher degree

(Continued on page 140)

*Formerly Designing Engineer, Liberty Electric Corporation.

Radio Apparatus for Amateurs

By G. Y. ALLEN

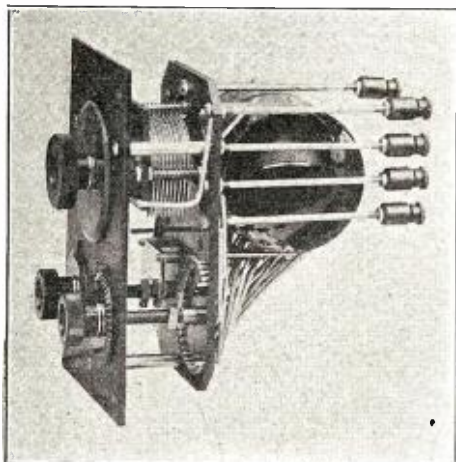

Inside View of the New Short-wave Regenerative Set. Note the Disposition of the Switches, Avoiding Capacity Effect From the Operator's Body.

THERE are those in the amateur radio field today who can well remember the average amateur radio station of 10 years ago, and as they allow themselves to reminiscently review those days of long ago, they wonder how those cigar box tuners and tin cracker-box condensers ever did work. The receiving set usually comprised a tightly coupled tuning coil, generally homemade and wound on practically any available form from one inch to a foot in diameter; an electrolytic or crystal detector, and a pair of held telephones weighing a pound or more. The transmitter usually consisted of a one-inch spark coil direct connected to the antenna. There were no Government regulations and the waves emitted were so highly damp that it was impossible to do any tuning. Only two amateurs could work at one time in the same vicinity, and it was amusing to hear one after another endeavor to get temporary command of the ether. The situation ensuing can easily be imagined when an amateur in Newark, N. J., for instance, was straining his ears to catch a long-distance message from some friend in New York, about the time some five-year-old in the next block opened up with his new spark coil. Needless to say, the ether warmed up to a white heat, and all to no purpose, for the would-be juvenile operator probably did not know the signal for the first letter in the alphabet and was entirely ignorant of the crime he had committed.

Today, such conditions have largely been removed. The Government has assigned a specified wave to amateurs and the rigidity of the requirements has acted as an impetus to the amateur to use better apparatus. Instead of the tuning coil crystal combination of a decade ago, the amateur's receiver now comprises tuned circuits using tapt reactors and variable condensers with vacuum tube detectors and amplifiers using the regenerative Armstrong feed-back circuits. Instead of the spark coil with its high decre-

ment, and low carrying power, the modern amateur has installed a fone set. In other words, the modern amateur's installation is on a par with the best commercial practice and the results obtained have kept pace with the strides made in station equipment. Trans-Atlantic radiophone using but 10 watts in the antenna is now a matter of history and the nightly feats of our amateurs proclaim again and again of the efficiency attained in the modern amateur's station.

Manufacturers of amateur equipment have been quick to realize the advance made in the radio art, and instead of a display of loose couplers, tuning coils, helices, etc., the manufacturers' catalogs today list cabinet receiving sets and panel type transmitters.

One of the many accomplishments of the war was the explosion of the prejudice against the single circuit tuner. Before the war, the amateur would not think of anything but a coupled tuning device when efficiency was desired. And with the old high resistance crystal detector as his only salvation, who could blame him for his stand? However, the complicity of tuning a coupled circuit, and the absolute requirement of reliability, together with the serious personnel problems in the Army and Navy prompted the investigation of the efficiency of the

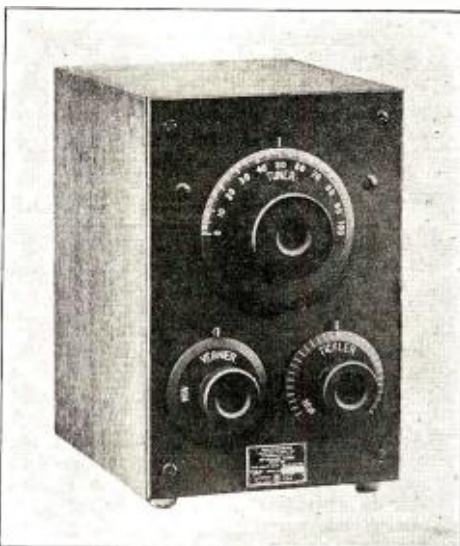

External View of the New Single Circuit Tuner.

single circuit tuner, with the result that it was widely used, particularly in the Army.

Contrary to the pre-war opinion, the single circuit tuner is efficient and can tune accurately. The objection due to inherent lack of selectivity to waves of high decrements has largely been removed by the increase in the use of efficient quenching on spark transmitters and by the increased use of continuous wave transmitters. Also by the incorporation of the Armstrong regenerative circuits, the selectivity of the single circuit receiver has been greatly enhanced.

A single circuit tuner which has recently been placed on the market includes so many novel features that it is worthy of description. It is designed to cover a wave-length range from 180 to 170 meters, using an antenna of approximately 500 microfarads capacity or more.

The front view of the tuner is shown in Fig. 1, and the internal view in Fig. 2, while Fig. 3 shows the internal wiring diagram.

It will be noted that the oscillating circuit consists simply of a variometer reactor and variable condenser connected in series

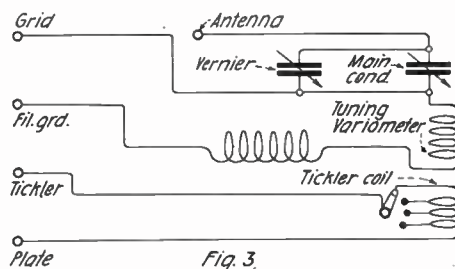

Hook-up of the Short-wave Receiver.

with the antenna and ground. Both the inductance and capacitance of the circuit are varied simultaneously by turning the large knob at the top of the receiver.

The advantages that accrue thru this arrangement are several. In the first place, a greater range can be covered than would be the case if only the capacitance or inductance alone were varied, unless the value of these quantities is increased considerably. Also, the efficiency of the oscillating circuit is maintained practically constant thruout the entire range of the receiver because the ratio of inductance to capacity remains practically constant.

The receiver is provided with a "tickler coil," which is inductively coupled to the main variometer and which permits regenerative amplification of the received signal. The tickler is adjustable by taps which are divided finely enough to give complete control of the feed-back coupling. The inherent amplification and selectivity of this circuit when used with a vacuum tube detector are well known in the amateur world.

In order to permit of accurate tuning at the short wave-lengths for which the tuner is designed, it has been found desirable to include some form of fine adjustment. This feature is provided in this tuner in the form of a single plate variable condenser connected in parallel with the main condenser. When receiving continuous waves or sharply tuned spark signals, the vernier is of great assistance in obtaining maximum intensity of signals.

An innovation in radio practice is embodied in the design in placing all terminals in the rear of the instruments. All wiring is thus removed from the face of the panel and placed on the back, where it is out of sight.

Appreciating that such desirable features as the Armstrong regenerative circuits are in demand by the amateur of today, and at the same time realizing that at the close of the war the market was woefully lacking in
(Continued on page 169)

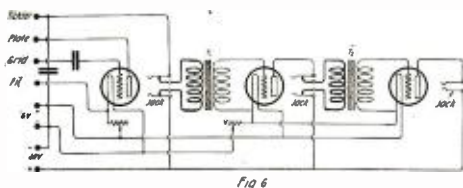
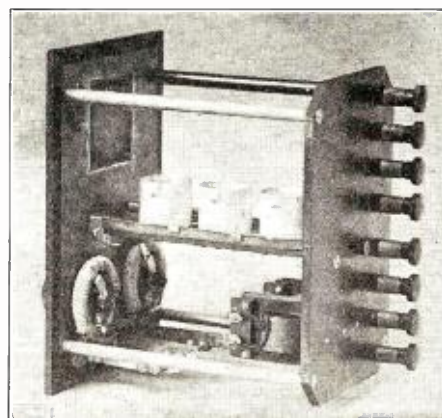

Diagram of Connections of the Improved Detector and Two-Stage Amplifier Shown on the Right of This Page.



Internal View of a New Model of Amplifier Embodying New Features. Note the Shielded Front Panel.

(Fotos by courtesy of the Westinghouse Co.)

Radio Experiments With Kites

By A. HENRY

SO much attention has recently centered about the use of kites for radio work, that a few remarks upon different designs, which have been found to be satisfactory, should be timely. The author, by reason of being connected with certain units of the Army, which did a great deal of kite and captive balloon work, while in France, as well as quite a bit of kite flying before the war, and making further experiments within the past few months, has been able to glean a few facts which may be of value to those who desire to avail themselves of the advantages the kite antenna offers.

After a series of tests with all manner of kites and captive balloons, it has been observed that for ordinary purposes there are three forms of kites which lend themselves readily as well as satisfactorily to this work. The captive balloon, because it is expensive, unwieldy and requires a supply of gas for its operation, may well be dropped from consideration at the outset. Even from a point of stability in the air, it is not to be considered the equal of one or more good kites.

THE THREE TYPES OF KITES

After eliminating the man-carrying kite, for the reason that it is a dangerous contraption, requiring the attention of more than one to get it up and keep it up and the attention of three or four to get it down, if there is any sort of a wind; the Japanese dragon kite, which is more picturesque than serviceable and one or two others of the same class, such as the hoople and star kites, we can confine our efforts to the Eddy, the Malay and the aeroplane kites, each of which may be used to serve a given purpose.

Of these three, the Eddy kite is by far the most satisfactory for all-round use, for the reason that it is easy to make, is quite portable and will fly with less wind than is required by either of the other two. The Eddy kite is shown at the left of one of the illustrations and it will be seen that the frame consists of but two sticks, placed at right angles to each other. The Malay kite is shown at the right of the same illustration and is quite the same in construction, with the addition of two cones, sewn to the front of the kite cover with an upright stick in the center of the cones. The arrangement of the bridle is somewhat different from that of the Eddy kite and its

These types of kites are particularly suitable for raising an elevated aerial. On the left is the "Eddy" kite, while on the right is the "Malay" type.



design is quite apparent. This form of kite has been found to withstand a very severe wind, when the other two types have been unsatisfactory, but it is rarely necessary to use it in conjunction with radio.

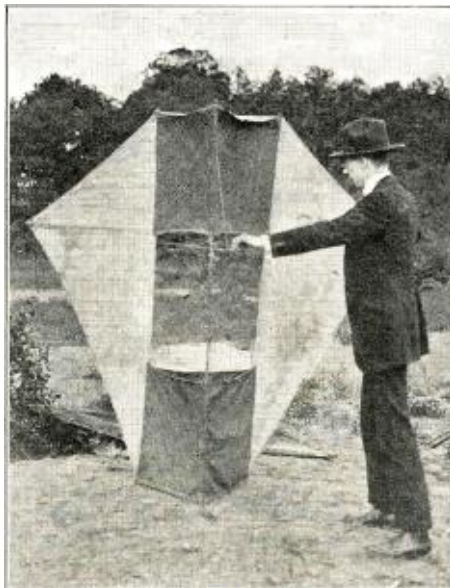

The Aeroplane Type of Kite. Note the Form of the Bridle.

The third form of kite, which may be used to advantage, is the aeroplane kite, which has something of the same general appearance of the ordinary kite we find strung

over the telegraf wires thruout the country. It differs, however, in that it, like the Malay kite, is supplied with two cones as well as an open space in the center. This kite is made with four sticks: two pass thru casing made in the colth which forms the cover, one each side of the rectangular hole in the center and passing from top to bottom: the third extends from tip to tip, across the back of the kite and the fourth passes thru the extended cones, from top to bottom. The bridle for this kite is made by fastening a string to the fourth stick at a point one-quarter the distance of the upper cone from its top and fastening its other end midway between the top and bottom of the lower cone; a second string extends from tip to tip and meets the bridle at a point in the same plane as the cross stick. This form of bridle may be seen in the illustration. The aeroplane kite will withstand a very heavy wind, but not quite as much as the Malay type. It is a very steady flier, if properly designed and requires less wind for its raising than the Malay kite. It has a very strong pull, for its size, altho it is not at all practical if it is made less than four feet in height, and five feet is much better.

THE EDDY KITE

Altho the Eddy kite will not stand a gale, it may safely be used in more than ordinarily strong winds by taking a few precautions, but first let us see how it is made.

Two sticks are necessary, both of the same length. A five, six or seven foot kite will serve very well for use with a wire "string." The general dimensions, it is necessary to remember, are very simple, as is

(Continued on Page 128.)

AWARDS OF \$100 PORTABLE RADIO PRIZE CONTEST FIFTH HONORABLE MENTION

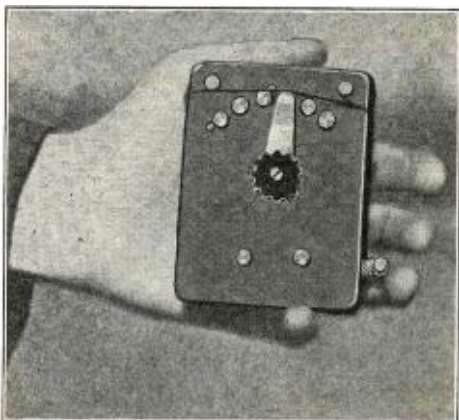

Here is Mr. A. L. Osborne's Portable Set Which is the Simplest Form of Receiver.

The set which I enter in the contest is $3\frac{1}{2}$ " long, 3" wide and $1\frac{1}{2}$ " high, and I have been receiving with it steadily for about three months. I made the outfit as a sort of experiment. The detector consists of a small oil cup filled with grains of galena silicon and iron pyrites, thru the top of which I have a cat-whisker which is attached to a thumb screw in the side of the box. This appears to work very well as a detector, and is very easy to adjust. The coil is somewhat on the style of the DeForest honeycomb coil, only my wire is wound on the inside, as well as on the outside of the cardboard cylinder. With this coil I can tune up to 800 to 1,000 meters, and receive amateurs, commercial Navy and ships. I have received these on a single strand, 50' aerial.

In my estimation, my outfit works fine and could not be better for its size.

ARTHUR L. OSBORNE,
1383 Nostrand Ave., Brooklyn, N. Y.

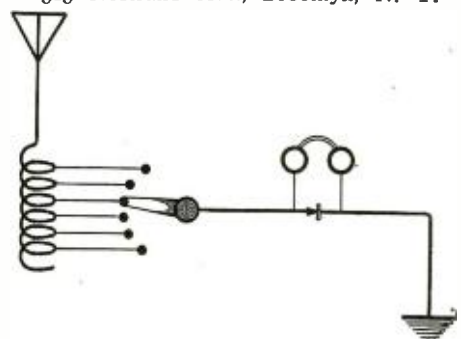

Hook-up of the Portable Set Shown in the Fotograf.

New Radio Apparatus

The Vocaloud

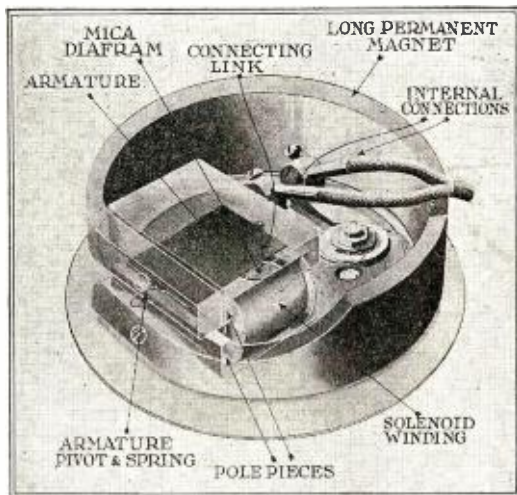

The Above Fotograf Shows the Inside of the Special Vocaloud Receiver. On the Left is a View of the Complete Apparatus Taken Out of the Cabinet.

The Vocaloud is an instrument used to greatly amplify Radio signals whether in the form of Radiofone or code.

The instrument, as its name implies, is one which has correct tone qualities for the reproduction of the voice.

A careful study of the fotograf will show that a balanced armature is employed, which is actuated by a magnetic field between four pole pieces, which field is caused to vary in accordance with the audio frequency component of incoming signal currents as the

energy is passed thru the single solenoid.

The movement of the balanced armature is conducted to the mica diafram by a small connecting link.

It will be seen that the action of this reproducer is exactly similar to that of a fonograf reproducer, except that in the latter case, the movement is set up by the vibration of the fonograf needle over the face of the record, whereas, in the former case, the movement is primarily set up in the armature. That is to say, the arma-

ture and connecting link is equivalent to the record and needle in the fonograf reproducer. This similarity between the fonograf and the vocaloud reproducer accounts for the perfect reproduction of Radio telephone concerts.

It does not matter greatly if the incoming signals take the form of a high pitched violin solo or the reproduction of a trombone or bass singer—the sound waves set up by the mica diafram will be just as true as those set up from the very best fonograf reproducer.

The Vocaloud further follows fonograf practice in the matter of the sound chamber. There is a certain fonograf on the market, using a moulded horn which not only amplifies the reproduced tone, but also gives true tone reproduction. The design of this particular sound chamber is adaptable for mounting inside a fonograf cabinet. The manufacturer is an acoustical expert and he, with his associates, developed the sound chamber as employed in the Vocaloud.

A study of Fig. 1 will show that the Vocaloud sound chamber very closely resembles the human ear, and indeed it is not unlike the trumpets used in ancient days. Any volume on Biblical History is sure to include pictures of trumpets very similar in design to the Vocaloud sound chamber. They too, no doubt, recognized the amplifying characteristics of the human ear.

The Vocaloud sound chamber is made of a specially prepared wood composition. This composition has unusual sound amplifying characteristics without causing distortion of the amplified sound waves. The

(Continued on page 128)

A Real New Crystal Detector

Altho the V. T. detector is today used by almost every amateur, there are still a good many who use the crystal type of rectifier. The crystal detectors are also used in portable sets and at several stations where batteries cannot easily be charged.

The new detector, described here, is a real novelty, in that to adjust it, the turning of a knob is all that is necessary. By means of an eccentric mounting, the cat whisker is automatically lifted from the crystal and again put in contact at another point.

The functioning of the device is extremely simple in principle, but at the same time it constitutes an ingenious application of cinematic motion.

The eccentric E, which is secured to the control head B (see Fig. 1), provides not only for the reproating movement of the exploring point, but also gives it a slight rotary motion in order to afford a change in the explored point at each revolution.

It should be remarked that this rotation is proportional to the distance between the axis and the surface C of the collar, and is therefore a maximum at the end of the rear stroke (as shown in Fig. 1) and zero at the end of the forward stroke (see Fig. 2), since the collar C passes thru the axis. In this manner no rotation is produced when the point is in contact with the crystal.

The above method will be better understood by comparison with a rotating disc which operates a friction roller adapted to move along a radial line, and in this combination the speed of rotation of the roller will be proportional to its distance from the center of rotation of the disc, this speed being zero when the roller is situated on the axis of the disc.

The same device makes it an easy matter to carry out the adjustment of pressure of the point, since it regulates the alternating stroke of the exploring point by simply turning the head in either direction.

The eccentric position of the axis A with reference to the horizontal axis affords a means for renewing the exploring region. The exploring point in fact describes a circle about its axis A and all that is required is to rotate the crystal cup thru a small angle in order to at once obtain a new exploring circle.

The device is automatically set in the fixt position by two special methods, which are used in conjunction.

1. The exploring wire is curved at its last spiral S in order to touch the socket upon which it is mounted.
2. The cover of the crystal cup carries a fine gauze or grating in insulating material into which the exploring point is caused to

penetrate, and it is thus automatically held fast.

It should be observed that this insulating grating has no prejudicial effect upon the proper contact of the exploring point upon the crystal.

The detector has a handsome appearance and is a very nice piece of apparatus, entirely made of moulded bakelite with polished brass parts. The base is fitted with two brass strips in which notches are provided to allow the detector to be mounted between two binding posts, either on a separate base or on a panel; this is very convenient in several ways. For instance, it may be adjusted in a minute on a V. T. set in case the V. T. ceases to function, and removed if not in use constantly.

This detector is a recent French invention and is patented under the name of "Exentro Detector."

Photo by courtesy of Bonnefont Co.

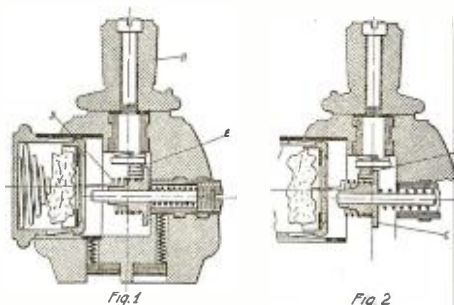
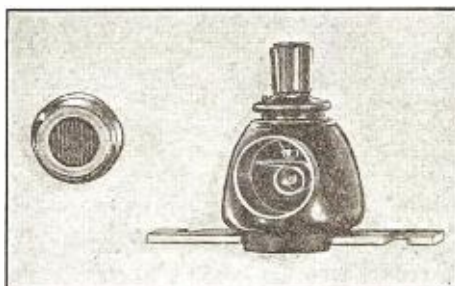

This New Crystal Detector Embodies Some Interesting Features. On the Left is a View of the Detector With the Crystal Cup Removed, Showing the Automatic Spot Finder, Which is Operated by Merely Turning the Top Knob. On the Right the Diagram Shows How the Contact is Made on the Crystal, and the Mechanism That Revolves the Cat Whisker.

Construction of a 1-K.W. Arc Converter

By D. R. CLEMONS

SEVERAL years ago it was thot improbable that the arc converter would ever compare favorably with the standard spark systems then so popular for marine use. Several commercial steamships were equipt with arcs and did creditable work with stations of the same system, but on proceeding to foreign ports, they experienced considerable difficulty in maintaining good service with coastal stations and vessels in those waters. The arc was considered an intruder in the field, for they, with their tikkers, did not appear as a possible competitor against our quencht units with carborundum mounts. Standard and efficient forms of converter are now constructed for marine use, and where operators were formerly trained in spark and tube systems, they are now also introduced to this very interesting device that has held its own with time.

In constructing an arc the builder is first embarrassed by the amount of lathe work required, and the cost of the raw material for its parts. Many desire an inexpensive and practical arc converter that can be constructed quite economically and not involve the extensive use of the more elaborate powered tools for shaping its parts. A recently constructed form of arc converter of 1-k.w. capacity is illustrated here. In designing this instrument an effort was made to avoid complicated parts, and to produce a practical unit that compares favorably with more elaborate instruments of equal power.

The arc is mounted vertically before an asbestos panel and cabinet base that also supports the switches, terminals, and carbon rotating motor. Two 20-ohm starting resistances and a flanged water cooling radiator are mounted behind the panel. The arc proper is assembled about a heavy box-

shaped bronze arc chamber provided with flanges for attaching it to the panel front. Both electrodes enter the gas-tight chamber by passing thru heavy brass bushings mounted in bakelite discs covering large openings. These openings are very large to provide suitable insulation for the electrodes, and are accurately machined to offer a good facing for the gaskets and insulating material covering them. Similar openings are provided for the iron core pieces of the blow-out coils above and below the arc chamber. A heavy brass cover is clamped in place by six heavy wing nuts and is provided with an ample pop-valve at its center to release the pressure of exploding gases when the arc is relighted after an extended idleness.

Grain or denatured alcohol is introduced into the chamber by the glass dropper shown above the upper pole. Alcohol passes thru a small hole in the upper pole and on into the vicinity of the flame where it is vaporized. Two large blow-out coils provide a strong traverse field about the arcing space. These are heavily insulated with asbestos, fibre, and sheathed in bakelite coverings. The field strength may be varied by altering the number of turns included in the lower coil

which is tapt at three values. Normally both coils are in series and in the positive side of the line.

During operation the arc is maintained between copper and carbon electrodes. An intense heat naturally results, and, as the copper terminal must be kept reasonably cool, some form of water cooling by circulation should be provided. If this were not done, the copper electrode would be burned away in a very few minutes. Generally, in commercial arcs, the water is pumped thru the circulatory system. Other forms may employ direct pressure water supply if this is available. The syfon system may also be where the power is not great or period of operation too long. In the syfon system, the heated water passes into a reservoir where it is cooled and again returned thru a small tube directed against the interior surface of the copper terminal. With efficient cooling, a copper terminal may last several hundred hours.

The activity of the blow-out magnets drives the arc flame outward from the arc centers, tending to increase its tension and efficiency of the generated oscillations. Ordinarily carbon burns away slowly, and may be fed in by hand, but the blow-out coils

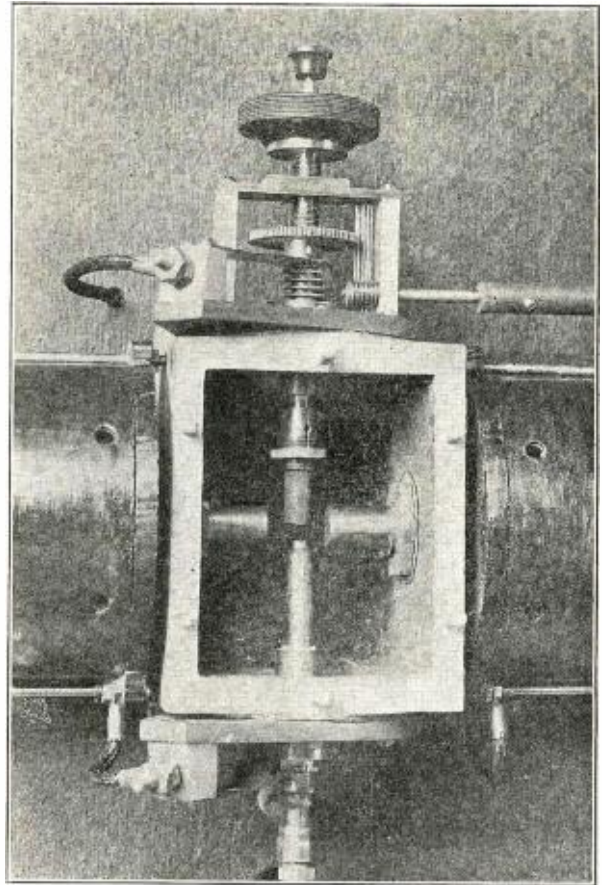

Inside View of the Arc Chamber. Atop of it May be Seen the Reducing Gears Rotating the Carbon Electrode to Make it Burn Evenly.

hold the flame to one side of the carbon which burns away at that point until the unburned portion may protrude across the gap and so cause a temporary short circuit. Then, too, the irregular surface that results, would cause the arc flame to wander from point to point and continually alter the characteristics of the arc and its emitted energy. To prevent this, the carbon may be rotated slowly by some mechanical arrangement which allows the surface presented to be effected equally. The speed of rotation is slightly less than one turn per minute.

The positive terminal is constructed as follows: a hollow copper electrode is brazed into the end of a heavy brass tube. A bronze compression coupling is threaded over the outer end and is provided with an outlet tube, and an inlet tube which passes thru the inside of the mount so that water is directed against the copper tip and returned thru the mount to its outlet. Rubber tubing conducts the water thru a large flanged tank mounted behind the panel. A heavy bronze strip connects the positive electrode and bushing with a large brass terminal block mounted upon a projection of the bakelite structure.

The carbon element and its controls are illustrated. A short section of solid carbon is clamped into a three-jawed compression chuck rotated by the reduction gearing shown. A spiral spring returns the electrode to its adjusted distance after the arc has been struck. Adjustment of the arc length is made by the large rubber knob at the extreme right. A hollow spindle passes thru the adjustment and terminates in a smaller knob. By pressing inward on the small knob, the entire part moves inward until both electrodes touch; and when released, the part returns to its adjusted position.

(Continued on page 162)

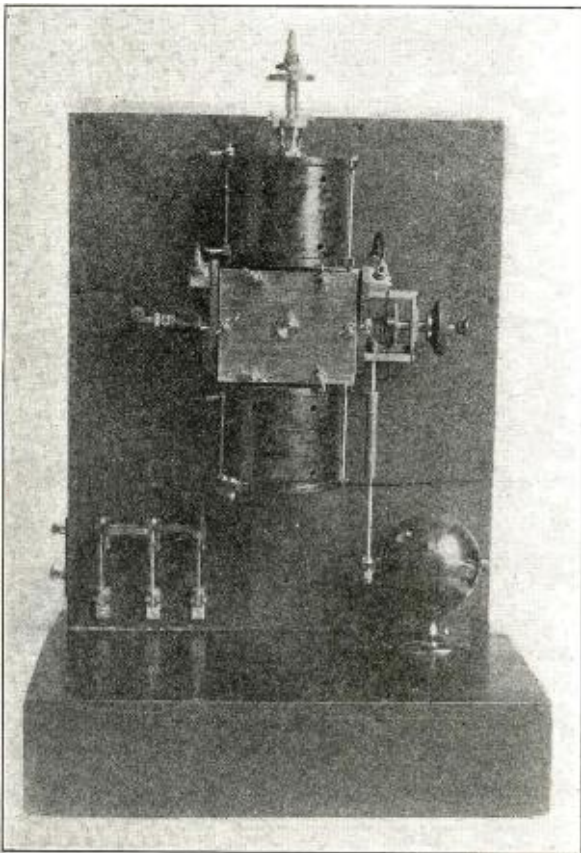

This Fotograf Shows the Complete Converter Mounted on a Panel. Note the Motor Rotating the Electrode.

Radio at N. Y. Stock Exchange

By ARTHUR H. LYNCH

PERHAPS there is no one place in the world where there is more money represented per square foot than in the New York Consolidated Stock Exchange, where trading is done in a single day amounting to millions of dollars. To the man or woman who has never been there before, there is something about the very atmosphere of the place which simply seems to savor of money, MONEY, MONEY.

From the public gallery, where visitors may watch the frantic actions and yelling of the traders, a very satisfactory view of the entire exchange may be had and it is never more interesting than just before the closing hour. So let us consider that we are in the gallery and that there has been an afternoon of very brisk trade and that the telephone wires, which are connected to the many extensions in little booths around the walls to our right and left, have had a most busy time of it. Most of the language of the traders is unintelligible to us and some of the signals from traders in the center of the floor to their telephone operators in the booths remind us of the semaphore method so frequently used by man-o'-warsmen. There is a shuffle of many feet and the strident voices seem to penetrate our very natures. Boys are running here and there, on very important errands. On two of the walls there are galleries similar to ours, tho a little lower, and upon them there are several stock tickers, from which men read the reports of trades, soon after they occur, and chalk them up on huge boards which are used for that purpose.

In the center of the floor there is a little desk upon which a very peculiar sort of machine, something similar to a typewriter, except that it has fewer keys, and these are in the form of a circle rather than as is the usual custom, may be seen. We notice that many of the boys run to the desk in the center and pass in little slips of paper. These are really records of the trades which have been made, and the operator of the typewriter-looking machine is the man who punches out the news which is received by the tickers on the balconies as well as other parts of the city and thruout the country. As soon as he has punched out a record of the sale, he places the little slip on file and the message, automatically received by the ticker on the balcony is tabulated by the chalkers.

LIGHTNING SPEED IN TRADE

In order to get in before the proverbial bottom drops out, it is sometimes necessary to know of the trading immediately after it has been done, but that is another story and needs no reiteration here. Of all things which go to make trading in the exchange, there is no more important consideration than speed and it is for this reason that no more time than is necessary is lost in getting the reports of the trading upon the boards, for the information of the members.

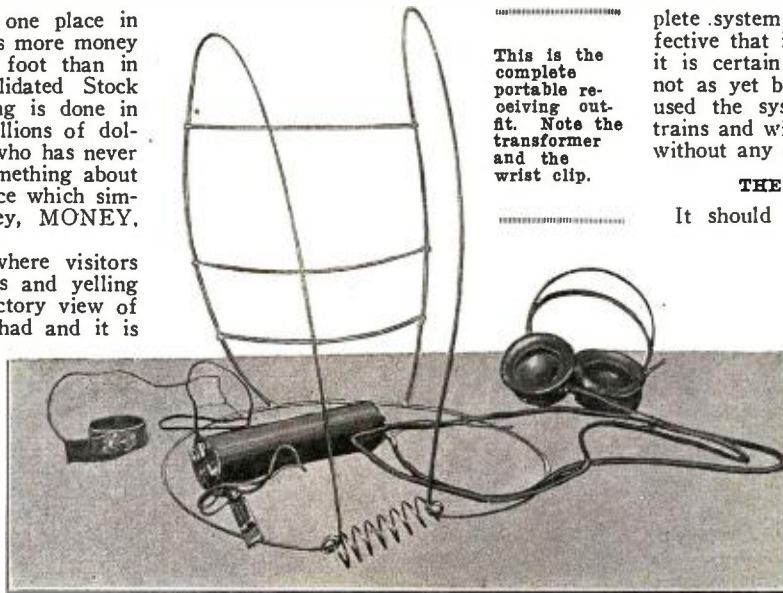

This is the complete portable receiving outfit. Note the transformer and the wrist clip.

plete system is so simple and so very effective that it will prove very valuable and it is certain to find adoptions which have not as yet been tried, tho the inventor has used the system for talking with moving trains and with the driver of an automobile, without any antenna or ground.

THE SIMPLEST RADIOFONE

It should be remembered that the men who put the figures on the boards are the men who will have to be satisfied that such a system as this works, and they proclaim that they are "tickled to death" with it. They are very enthusiastic rooters for it, and one of the principal reasons for this is that in addition to eliminating the necessity of their going back and forth to and from the ticker or listening to a man shouting at them thru a megafone, they hear the stock quotations, while most of the surrounding din is eliminated by the telephone receiver and they are not hampered with a bulky radio set, such as we would ordinarily expect to see. Can you imagine anything so simple as a receiving set which consists merely of an antenna in the form of a wire vest connected to one terminal of a transformer about the size of a telephone repeater coil with the opposite side of the same winding connected to a bracelet which is worn on the operator's wrist and the two terminals of the other winding simply connected to a pair of telephone receivers? That is all there is to the receiver, tho a few changes are soon to be effected, which will even eliminate the transformer, and the telephone receivers will be directly connected to the "aerial" and "ground," so that all the operator will need are the fones, the vest and the bracelet.

THE AUDIO FREQUENCY RADIOFONE TRANSMITTER

Mr. William Wallace Macfarlane, of Elkins Park, Penn., is the originator and developer of the complete system, as well as the holder of many patents, in this country and other places, relating to this and other forms of audio frequency wireless telephoning. He is very enthusiastic about radio and its possibilities and this application in the Consolidated Stock Exchange is but one of many similar exploits. In developing the various systems which Mr. Macfarlane has conclusively proven to be effective for forms of communication not found in use today, there is associated Mr. D. W. Mulford and the arrangements for the trial at the exchange were made thru Mr. Louis Gilbough, Chairman of the Arrangements Committee.

Mr. Macfarlane makes use of the simplest transmitter, just as he does of the simplest receiving circuit. All there is to the transmitter is the 12-volt battery for supplying the power, a microphone transmitter of the ordinary telephone type having a button on the handle to cut it in and out of circuit, so as not to waste the battery (Continued on page 170)

With six or seven tickers in operation, and each being the source of information for a chalker, who has charge of a given length of the huge board upon which his particular stocks are to be found, and brisk trading in progress, the action is very great and the entire layout is very interesting to all but those who are so unfortunate as to be losing their fortunes, for just as sure as some win, others lose. In most instances the information which the tickers on the balcony tick is read by a man with a megafone, who then shouts it above the din to the chalker in that section, who in turn gets it up on the board. But, even with all this precaution to secure speed, there are times when the reports of trades do not appear on the boards for some minutes, and huge sums may be lost in that time, so we find that any new device which is designed to save time is welcomed at the exchange and it is here that our versatile art finds a very unique and satisfactory application, which it is expected will soon do away with several of the tickers, or, at least put them on the inactive list, except at such times as when something may go wrong with the radio outfit, which will be an almost impossible condition, if reasonable care is taken of it. The com-

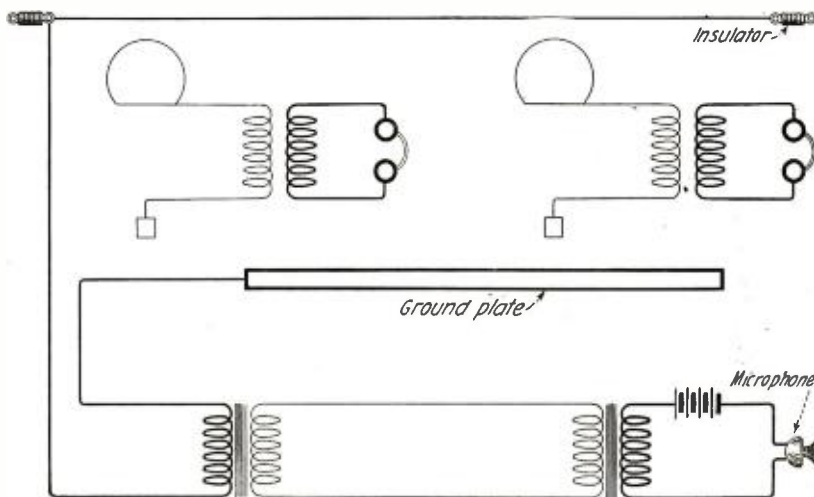

This Diagram Shows the Complete Audio Frequency Radiofone Installation of the New York Consolidated Stock Exchange. Two Portable Sets Are Shown. They Consist of a Cage Aerial With Ground Made Thru the Body of the Man Wearing the Set. If High Resistance Telephones Are Used, the Telephone Transformer May be Dispensed With.

Broadcasting Radio Market News By the Missouri State Board of Agriculture

By DANIEL C. ROGERS
State Marketing Bureau, Jefferson City, Mo.

THE Missouri State Marketing Bureau of the Board of Agriculture, with headquarters at Jefferson City, Mo., is working out extensive plans for giving Missouri farmers government market news by Radiofone.

The government market news information will be received at the Radio office of the State Marketing Bureau off the leased wire of the United States Bureau of Markets. That wire will connect Jefferson City with the office of the Bureau at Washington, as well as with practically all of the large grain, live stock, hay, fruits and vegetables, dairy products, and other markets in the United States.

A powerful transmitting set will be installed at the offices of the State Marketing Bureau at Jefferson City, located in Missouri's beautiful new capitol building whose dome is 280' from the ground. From this central point of the State the Radiofone should operate at its maximum efficiency to the advantage of Missouri farmers. The service is expected to be begun early in the fall.

The Missouri State Marketing Bureau will organize the wireless amateurs in that State, of which there are several thousand widely scattered in rural communities, into a State organization for receiving and distributing the market news information. A continued campaign will be made to install Radiofone receiving outfits in every town of any size in the State. Newspapers, banks, rural telephone exchanges, farm bureau offices, live stock shipping associations, elevators and other headquarters interested in receiving and distributing government market news information on farm products will be requested to cooperate in this new undertaking.

During the strawberry shipping season from Southwest Missouri last May, the Missouri State Marketing Bureau purchased a Radio receiving outfit for receiving strawberry market news at Monett, Mo., which was undoubtedly the first Radio equipment ever purchased by a State or national agency for the purpose of receiving and distributing market news information for the farmer.

Similar service is being rendered in the watermelon district of Southeast Missouri, with the big watermelon shipping season opening up in that part of the State the latter part of July.

The purchasing cost of a Radio receiving set does not exceed and may be less than the cost of transmitting the market news information for a single season, to market news field stations by the commercial telegraph company. There is no comparison between the swiftness of sending the news information by commercial telegraph companies and Radio to a field station from either St. Louis or Kansas City.

A Radio receiving set is now being operated by the State Marketing Bureau at Jefferson City to receive government market news information now broadcasted daily from the KDEL office operated by the Post Office Department at St. Louis, Mo. This information is being given to local newspapers and the Associated Press.

The plans for putting into operation this most elaborate system of distributing market news information to farmers ever un-

dertaken by any State, or even the Federal Government, has been generally pronounced feasible by the majority of the larger manufacturers and jobbers of Radio equipment.

At first no attempt will be made to expand the work in Missouri further than installing receiving sets at some important office in each of the several important towns of every one of the 114 counties in Missouri.

Sufficient interest has already been expressed in the project to warrant the belief that farmers, bankers, county agents, newspapers, rural telephone exchanges, dealers in farm products, merchants and others, will liberally subscribe to the purchase and maintenance of one of these Radiofone outfits in their respective communities, which cost would be only trivial when thus apportioned between the leading citizens of a given community. In fact, the cost for maintaining such a service by individuals is not expected to be prohibitive within the near future. In view of which fact, the State Marketing Bureau of Missouri is looking forward to encouraging the installation of inexpensive Radiofone equipment in thousands of farm homes throughout Missouri.

If this ambitious program is worked out to a success, there will be a new version in

With the standards of the peoples plunging thro' the thunder-storm;

*"Till the war-drum throb'd no longer, and the battle-flags were furled,
In the Parliament of man, the Federation of the world."*

Truly, it does not seem to be such a "dip" into the future as far as Tennyson professed concerning commerce and naval engagements by air craft to the realization of the wonderful possibilities of the wireless telephone and telegraph. By "dipping into the future" only a few years, however, the Missouri State Board of Agriculture believes that thousands of Missouri citizens may be able to sit in their homes and hear the debates in the Legislative Halls of Jefferson City relative to the "farmers' monopoly on food products," the question of "regulating airship traffic," and other important future topics for Legislative consideration.

The first really big step in the Missouri program will be a Radio exhibit at the Centennial State Fair to be held in Sedalia, August 8-20, 1921. This new idea in connection with a market exhibit at an agricultural State fair will certainly fit into the Centennial program—Missouri's celebration of her 100th birthday. One does not have to go back into Missouri history or the history of the Nation 100 years to make a comparison of the slow means of communication of former years to that of the wireless telephone as it has been so excellently perfected within recent years. This and other comparisons between modes of travel, communication, and living in Missouri in 1821, when that empire State was admitted into the Union, and 1921, will be made by hundreds of other exhibits at this great mid-western Centennial State Fair.

Doubtless, the Radio market news furnished to the farmers attending the Missouri State Fair will remind them that marketing problems in the State in 1821 were quite different from those of today. Most any kind of news in that early day in Missouri was more of a curiosity than an every-day occurrence, or necessity. Certainly market news of any kind for the farmer was unheard of in 1821. If it had been available, the crop of the next season would have been ready for market before the market news concerning the preceding crop could be received.

Who will venture to picture the state of affairs that will exist, not only in agriculture but in every activity of life, when the wheels of evolution shall have brot Missouri farmers back to Sedalia in 2021 to celebrate the State's second anniversary?

When the State Fair has ended, then commences the circuit of county fairs which last until the middle of October. While it may be impossible to get into each of the 114 counties of that big State, the Missouri Board of Agriculture intends that its State Marketing Bureau shall establish Radio connections with many of the county fairs and its offices at the State Capitol at Jefferson City. This work will bring the feasibility of distributing government market news from the offices of the State Marketing Bureau at Jefferson City to the farmers in every county of Missouri in an

(Continued on page 162)

THE present article will certainly interest the entire Radio Fraternity. It is the first time that any state of the Union has not only recognized Radio officially, but is going to the trouble to make Radio a state-wide utility. The State of Missouri will very shortly broadcast market news throughout the State, and is now taking steps to install Radio apparatus in all the principal Cities and every County in the State.

Would it not be well for our Radio Fraternity to take steps in all of the States in the Union to have the State authorities follow the lead of the State of Missouri? Amateurs living in the capitals of the various States have a big opportunity before them that should not be overlooked—Editor.

Missouri of the old poem entitled "Why Boys Leave the Farm." In addition to receiving valuable market information on wheat, live stock, cotton, fruits and vegetables and other farm products, farmer boys and girls in Missouri will be able to sit in their homes and entertain their friends by listening to a concert given by the Minneapolis Symphony Orchestra at Minneapolis, or to Galli-Curci or Caruso in Chicago or New York. Hundreds of other events of intense interest are witnessed daily by boys all over the United States who have installed Radio outfits at their homes.

Alfred Tennyson in his poem entitled "Locksley Hall," written in 1842, said:

*"For I dipt into the future, far as human eye could see,
Saw the Vision of the world, and all the wonder that would be;*

*"Saw the heavens fill with commerce, argosies of magic sails,
Pilots of the purple twilight, dropping down with costly bales;*

*"Heard the heavens fill with shouting, and there rain'd a ghastly dew
From the nations' airy navies grappling in the central blue;*

"Far along the world-wide whisper of the south-wind rushing warm,

Operation of Vacuum Tubes in Parallel

By JESSE MARSTEN

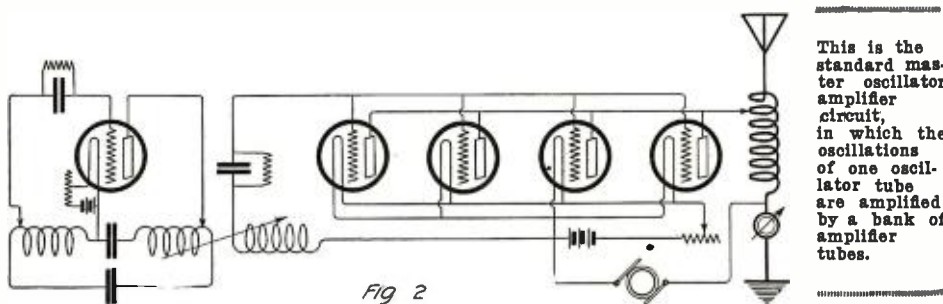

Fig 2

This is the standard master oscillator amplifier circuit, in which the oscillations of one oscillator tube are amplified by a bank of amplifier tubes.

THE power obtainable from vacuum tubes is quite small on the average, even from the so-called high power tubes. The General Electric type "P" Plotron, for example, gives about 150 watts output, using 1,500 volts D. C. on the plate at normal filament brilliancy. And when we consider the lower voltage tubes and amateur transmitting tubes, the powers become much smaller. Consequently until the time when higher power tubes are really developed and perfected from a commercial point of view, it will be necessary to operate tubes in parallel in order to obtain high powers.

Two methods of operation are thus available:

1. Connection of the tubes in parallel and operation of the entire bank as primary oscillators.
2. One master oscillator tube feeding the balance of tubes in parallel as amplifiers.

In order that a number of tubes operate in parallel regularly and steadily, they must fulfill the condition of uniformity of construction. The mechanical disposition and construction of the internal elements must be alike in the different tubes. It is obvious that it will be very difficult, and in cases impossible, to get tubes of different design to operate stably in parallel, the difficulty increasing the greater the differences in design. This difficulty likewise arises when tubes of the same design are operated in parallel as oscillators, there being, however, variations of one sort or another in the different tubes, as for example, variations in the distance between the internal elements due to faulty construction or assembly, differences in the amount of gas in each tube, and so on. It is evident that the difference between this case and the previous one mentioned is one of degree only.

This difficulty in the operation of tubes in parallel will not be apparent when tubes are operated individually. That is, if a one-tube set is designed it is possible to interchange valves without altering any of the adjustments and the circuit will oscillate quite regularly, with perhaps some variations in output at the worst. However, as soon as tubes are placed in parallel this difficulty becomes apparent, and is more and more so as the number of tubes increases.

In order to clarify the discussion we will consider a standard oscillating circuit as shown in Fig. 1, where L_g is the grid tap, and L_p is the plate tap. This circuit will oscillate at maximum output when the proper choice of plate tap is made, and the oscillations will be regular and stable within certain limits of the grid tap. Now if two similarly designed tubes differing somewhat in the mechanical spacing of the elements on account of faulty construction (a quite conceivable state of affairs) are operated in parallel, it is evident, unless individual grid and plate taps are chosen for each tube, that tap chosen may be too high or low for either one or both, in which case both tubes will not contribute their best output. A

mean grid tap may be chosen, but the larger the number of tubes the more difficult it will be to secure this mean tap suitable for all the tubes, and if the differences in the tubes are very marked, it may be impossible to obtain a mean tap.

Even if the tubes are assumed to be all uniform there will be some difficulty in securing stable operation of a large number of tubes in parallel. Let us assume that L_g is the inductance of the grid tap, and L_p is the inductance of the plate tap required for the stable and best operation of one tube. Let us assume that oscillations will be stable with an allowance of 25 per cent. on either

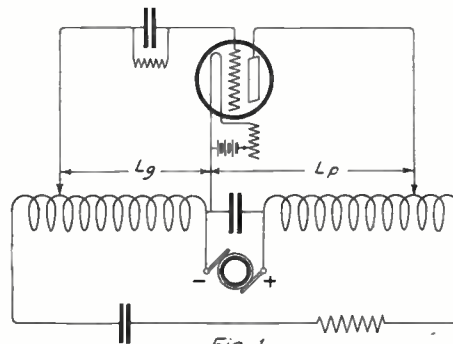

Fig 1

In This Typical V.T. Oscillating Circuit the Value of Grid and Plate Inductance May be Adjusted for Best Oscillating Condition.

side of L_g , i. e., oscillations will be stable with a grid inductance of $L_g \pm 25$ per cent. L_g , or $L_g \pm \frac{L_g}{4}$. If a number of

tubes are operated in parallel the grid tap is reduced, and as will be shown below, it is reduced in the proportion inversely as the square root of the number of tubes operated in parallel. Thus if n tubes are operated in parallel and the grid tap for one tube is L_g , then the grid tap for n tubes will be $\frac{L_g}{\sqrt{n}}$. Assuming that the n tubes will oscillate stably and regularly with the same allowance of tap as one tube, namely 25 per cent. either side of $\frac{L_g}{\sqrt{n}}$, then the range of grid tap over which stability is secured is that given by $\frac{L_g}{\sqrt{n}} \pm 25$ per cent., which is smaller than that of one tube. This range becomes smaller the larger the number of tubes in parallel, and thus the margin of table operation becomes more and more critical.

In this radio-fone circuit using amplifier tubes, there is an advantage in coupling the grid circuit of the amplifier to the plate circuit of the master oscillator, in order to avoid the variations which may occur.

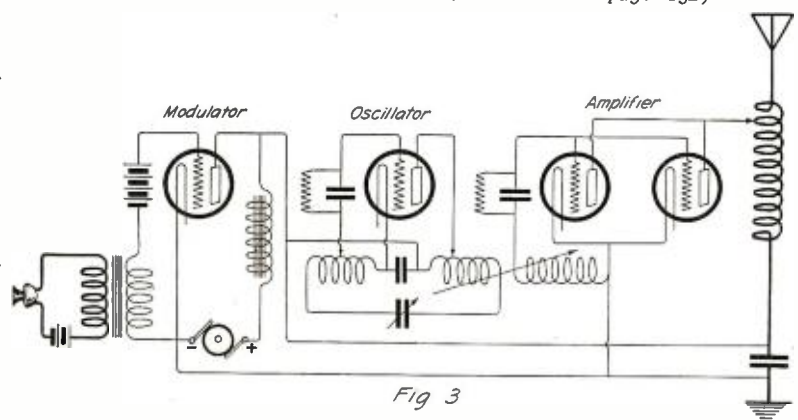

Fig 3

late stably and regularly with the same allowance of tap as one tube, namely 25 per cent. either side of $\frac{L_g}{\sqrt{n}}$, then the range of grid tap over which stability is secured is that given by $\frac{L_g}{\sqrt{n}} \pm 25$ per cent., which is smaller than that of one tube. This range becomes smaller the larger the number of tubes in parallel, and thus the margin of table operation becomes more and more critical.

To clarify this point let us consider a numerical illustration, and assume that one tube requires a grid inductance or tap corresponding to 10. It will oscillate stably and regularly with a grid tap of 10 ± 25 per cent., or between the limits of 7.5 and 12.5, thus giving a stable range of operation of five units. ($12.5 - 7.5 = 5$.) Now assume that four of these tubes are operated in parallel. The grid tap will then be given by $10 \div \sqrt{4} = 5$, and the stable range of operation will be given by the limits of 5 ± 25 per cent., or 3.75 and 6.25, the range being 2.5 units. ($6.25 - 3.75 = 2.5$.) Thus it is evident that the stable range of operation of a number of tubes in parallel is smaller and therefore more critical than that of one tube. It is, therefore, quite evident how much more critical operation in parallel of irregular and non-uniform tubes is likely to be, and how important it is for tubes to be made strictly alike in all respects.

VARIATION OF GRID TAP WITH NUMBER OF TUBES IN PARALLEL.

As mentioned above, the grid tap for a number of tubes in parallel is less than that required for one tube. In deriving this conclusion quantitatively and qualitatively it is assumed legitimately that the voltage applied to the grids of a number of identical tubes in parallel is the same as that required by one tube. In other words the grid tap or voltage required by a tube is independent of the number of tubes with which it is operated.

The physical explanation of the conclusion of a smaller grid tap is as follows. The power output of one tube is P . If n tubes are operated in parallel the power output is then nP . If the output current of one tube is i , then that of n tubes is $\sqrt{n}i$. Since the voltage applied to the grid of one tube is proportional to the product of the grid inductance and current, it follows that the grid inductance for n tubes will be less than that for one tube, in order to obtain the same grid voltage.

Let E be the voltage necessary for the grid, constant for 1 or n tubes.
(Continued on page 152)

Radio Frequency Ammeters

By S. SOLOMON

ONE of the most important measuring instruments, by far, used in radio practice is the radio frequency ammeter. It is essential in transmitting sets where the radiation is indicated, it is the basis of nearly all important radio measurements, such as resistance, audibility and so on. It is well known that if a number of radio frequency ammeters are placed in series, the readings may differ very markedly among them. The design of these ammeters, the conditions they must satisfy and the possible sources of errors of these meters, should be a subject of profitable discussion for amateurs.

The general types of ammeters used in direct and alternating current measurements are unsuitable for work at radio frequencies. The best type of radio ammeter is the hot wire ammeter. This type of meter is the simplest in construction, and as will be apparent from the reasons given below it is essential that the construction and geometric form of the radio frequency ammeter be extremely simple.

Since radio frequency ammeters may be used on a series of wave-lengths which may vary between such extremes as 200 meters and 10,000 meters, it will be at once evident that one important condition which the radio ammeter must fulfill is that the indication of the ammeter be independent of the frequency. It is also important that the total current to be measured should be effective in actuating the recording mechanism. These conditions prohibit at once the use of the usual electrodynamic or electromagnetic type of instruments, in radio circuits (alho suitable for low frequency circuits). In the first place the properties of iron or other magnetic material vary markedly with the frequency, thus making the true indication of an electromagnetic meter very uncertain and unreliable at radio frequencies. In the second place, these types of ammeters require the use of coils of wire in the internal mechanism. These coils have appreciable inductance and some distributed capacity (between turns and from turns to ground case). On the high frequencies, low wave-lengths, the coil offers a high inductive impedance to the flow of current thru it, but the capacitive impedance at high frequencies is very low, and therefore the current will flow thru the distributed capacities and to ground, instead of thru the coil, where it will actuate the meter. Thus all the current to be measured does not flow thru the meter and inaccurate results are thereby obtained.

In the second place, the reading of this type of instrument is dependent upon the wave-length or frequency of the current to be measured. For, if the self-inductance of the ammeter coil is L , and its distrib-

uted capacity C , then the impedance of each of these will be $2\pi fL$ and $\frac{1}{2\pi fC}$ respectively.

The higher the frequency of the current the greater the coil inductive impedance and the less the capacitive impedance. Therefore, the greater the frequency the less current will actually flow thru the ammeter coil. That is, the distribution of current thru the coil and the side capacities will vary with the frequency with the resulting variation of reading with wave-length. Thus we see that the usual type of ammeters as used for low frequency currents are entirely unsuitable for radio frequency work.

From the above it is seen that the internal parts of a radio frequency ammeter must have a minimum of inductance and capacity; that is, in its geometric shape it must be as simple as possible. The simplest mechanism for an ammeter which will have minimum inductance and capacity is a straight thin wire, and the easiest way in which this wire will indicate the magnitude of the current passing thru it is by means of the heating effect. It is for this reason practically all radio frequency ammeters are of the hot wire type.

Unless certain precautions are observed, even this type of ammeter will have its record dependent on the frequency of the current to be measured. This will be clear from the following discussion. The distributed capacity of the wire is now practically negligible and we have only to deal with the resistance of the wire and the self-inductance. Let R be its resistance and L its inductance. Then the current thru the wire will be proportional to the impedance, which is

$$R + 2\pi fL$$

since the frequency entering the current will be proportional to the wave-length. In order that this should not be the case, the value of R must be very much greater than the value of $2\pi fL$. This is accomplished by using for the hot wire of radio ammeters very high resistance wire such as German silver, or Constantan, or Manganin. These materials have very high specific resistances, which make the inductance negligible compared to resistance and thus avoids errors due to the frequency term.

It is thus seen that the current so far will be proportional to the resistance of the hot wire. The reading of the ammeter is proportional to the heating effect of the wire, which may be put down as

$$H = Ri^2$$

Now it is well known that the resistances of a wire at radio frequency increases as the frequency increases, and consequently here, too, there might be a possible source of error. However, if the hot wire is made thin enough, so that the skin effect will be very small, then this change in resistance due to frequency change will also be negligible. The particular size wire which is necessary to accomplish this depends upon the material of the wire. For the materials most generally used, namely those mentioned above, German silver, Manganin, and Constantan, if the diameter of the wire is not greater than 0.4 millimeters the errors due to resistance variation with frequency will be negligible.

So far then in order that a simple radio frequency ammeter register correctly it should be a hot wire meter made up of a thin wire, having high resistance and very small diameter. It will be evident that such an ammeter will have a very limited current carrying capacity, possibly not more than two or three amperes at the outside. If currents greater than this limit are passed thru the wire, it will become overheated, its

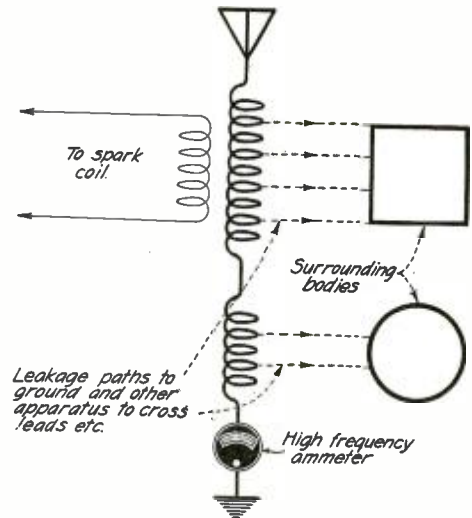

Fig. 4

When Conductive Bodies Are in the Neighborhood of the Transmitter Some Leakage Occurs That is Very Detrimental to the Efficiency of the Set.

properties will be altered and the readings therefore will not be reliable. The question then arises of the construction of a radio frequency ammeter which will carry larger currents.

In direct current work and low frequency current work the simple remedy is to use a shunt across the ammeter. This shunt is calibrated in conjunction with the ammeter and will serve excellently to increase the range of the meter. The use of shunts in radio is, however, not permitted at all for the following reason. Consider a simple hot wire ammeter across which is connected a shunt, Fig. 1. R and L represent the constants of the hot wire, R_s and L_s represent those of the shunt. The currents thru each will be inversely proportional to their impedances according to the usual rule, therefore

$$\frac{i}{i_s} = \frac{R_s + 2\pi fL_s}{R + 2\pi fL}$$

Thus it will be evident that with the use of a shunt the current distribution will be dependent on the wave-length or frequency. Consequently unless the shunt is actually calibrated for each wave-length the readings of the ammeter will not be accurate for the different wave-lengths.

A modification of the single wire ammeter for the conduction of heavy currents can be made by the use of two or more hot wires connected in parallel, the hot wires being identical to one another. Let us consider the case of the hot wire ammeter employing two wires. This method, if carefully considered, is really identical to shunting one hot wire by the other, and so the objection raised in the previous paragraph about shunts should hold here also. But, as stated, if the two hot wires are identical then the objection will not hold. For, suppose the two wires are the same, then their inductances and resistances will be the same, assuming that the length and diameters of the wires are equal. Then the currents thru each wire will be inversely proportional to their respective impedances, which is

$$\frac{i_1}{i_2} = \frac{R_1 + 2\pi fL_1}{R_2 + 2\pi fL_2}$$

This equation can be written in a different way as follows:

(Continued on page 150)

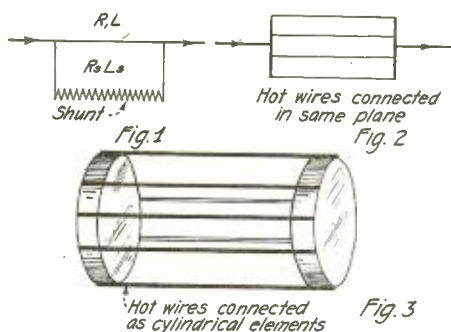

A Few Typical Arrangements of the Hot Wires in Radio Frequency Ammeters, as Used in Antenna Circuits.

Antenna and ground tests

Antennae, grounds and counterpoises	Radiation in amps. (max.)
200 m. antenna as antenna	No. 1
400 m. antenna as counterpoise	
Grounds water pipes	
Grounds gas pipes	
Grounds 2 steam pipes	
Grounds copper plate (4' square)	.95
400 m. antenna as antenna instead of 200 m.	
400 m. antenna as antenna	No. 2
Copper plate as ground	.65
Same but with water pipe ground in addition	No. 3
Same as No. 4, but without copper plate and using water pipes	No. 4
200 m. antenna	No. 5
400 m. antenna as counterpoise	.69
Water pipe ground	No. 6
Gas pipe ground	
Same as No. 6, but with 2 connections to steam pipes in addition	
200 m. antenna	No. 7
Water pipe ground	.92
400 m. antenna as counterpoise	No. 8
Same as No. 8, but with gas pipes in addition	
	.50
	No. 9
	.675

TUBE TESTS

Left	Center	Right	Amps. radiation	Amps. input into filaments
X	X	X	.90	4.1
X	X	X	.850	4.5
X	X	X	.850	3.0
X	X		.80	3.0
	X	X	.780	2.8

It will be noticed immediately that the tests are only given for two and three tubes; this is because one tube did not have any advantage over the employment of general amateur tubes. Also it will be noted that the input into the filaments effects the

output of the tubes, and that two tubes of the same type gave as great an output as three tubes, two of which were alike. In the LH and RH sockets were V.T.-2's and in the C socket a 101-B tube. The outputs of the tubes given here were not the maximum obtainable, because with the field of the generator short circuited the amperage would rise to 1.20 amps., but it was not steady. This is because the motor which drives the generator was too small, it being only 1/4 H.P. During ordinary operation the set draws but 190 milliamperes at the most.

When the set was first started the great-

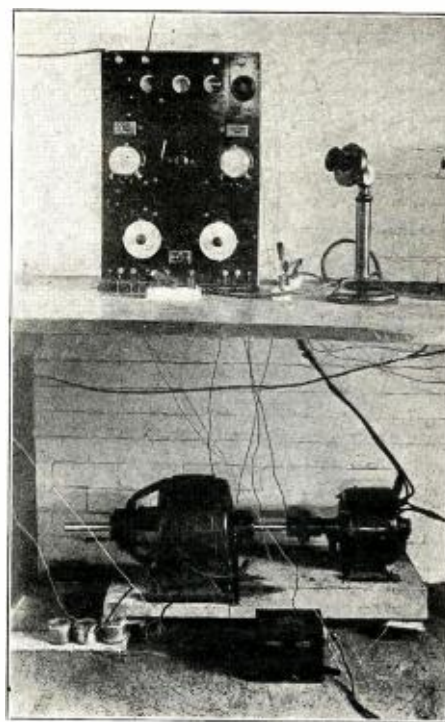

On the right, the photograph shows the complete set and the motor generator. On the left is an interesting chart showing the results obtained with this apparatus.

est radiation obtainable was only about 0.5 amp.; this was altogether too small, but no adjustment of the apparatus would give forth any increase. Fortunately it soon occurred to us that perhaps if the ground circuit was increased the radiation would go up. Trial proved this belief to be correct. Immediately scouting parties were sent out to find every possible ground within the building. Perhaps a chart of these (Continued on page 138)

A Simple Radiofone Operated on Six Volts

By ERNEST GRAUGER

FOLLOWING is a description of a simple radiofone made entirely from "junk" which may be found in any Radio experimenter's workshop. With this set using a single Western Electric power tube surprising results have been obtained.

Litzendraht is employed in the winding of the inductance and consists of twenty strands of No. 38 enameled wire. The inductance is wound on a tube 4 1/2" in diameter and 6" long, and consists of 100

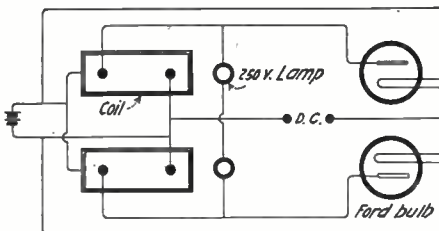

As a Source of H.T. Two Ford Spark Coils May be Used With Rectifier Tubes.

turns of Litz. It has twelve taps taken off as follows: 5, 5, 5, 5, 10, 10, 10, 10, 10, 10, 10, 10. These are brot out to the contact points on the left hand switch in the panel layout, Fig. 1. The contact points on the left hand switch are connected in parallel to the ones on the right, as shown in Fig. 2.

The variable condenser used is a De-Forest type C. V. 500. As this condenser short circuits on 90°, a hard rubber stop should be used to prevent this, otherwise no signals would be transmitted.

The rheostat used to control the filament temperature is a Paragon, which is noted for its high insulating quality. The rheostat used should have an actual carrying capacity of two amperes, as a Western Electric tube takes approximately 1.3 amps.

The microphone was purchased from the Electro Importing Co. I tried many others with varying amounts of carbon, but found that the E. I. Co.'s worked as good as any of them. A six-volt battery is used in series with the primary of the modulation transformer and the microphone.

A Ford spark coil is used for modulation transformer, and works efficiently.

The resonance indicator is a very simple instrument and consists of a turn of copper wire shunted around a 2-volt bulb, as shown in Fig. 3. The amount of wire in the circuit is varied by the switch blade, Fig. 3.

There are many ways of obtaining the high tension for a wireless telephone. The most efficient is the 500 V. storage battery. the most practical is the motor-generator and rectified A. C. is the cheapest. I am going to give a very simple method for obtaining the D. C.. The necessary materials are as follows:

- Two Ford spark coils,
- Two Ford headlight bulbs,
- Two 250 V. 16 C. P. bulbs,
- Two lamp sockets,
- One 6-volt battery.

(Continued on page 148)

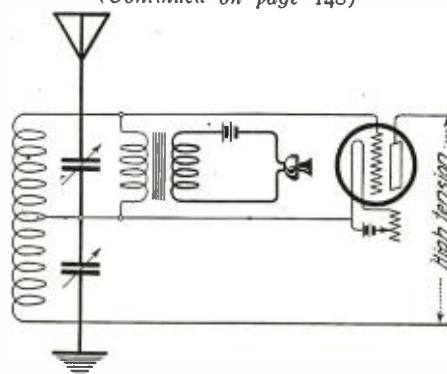

Fig. 5. Diagram of Connections of the Five-watt Radiofone Set.

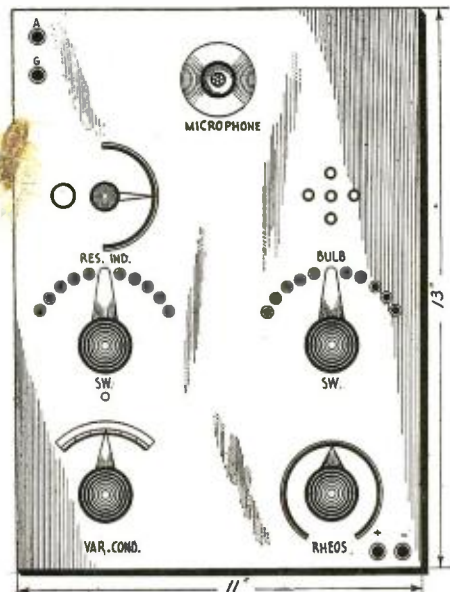

Fig. 1. Front View of the Simple One-Tube Radiofone.

RADIO DIGEST

THE DISTRIBUTED CAPACITY OF INDUCTANCE COILS.

By G. Breit.

SYNOPSIS

Effective Capacity of a Coil Defined.—Experiments show that if a coil is connected in series with a condenser of capacity C , the frequency ($\omega/2\pi$) with which this combination is in resonance is given by $L(C + C_0) = 1/\omega^2$, where L and C_0 are constants.

The constant C_0 is called the *effective capacity* of the coil, sometimes simply "the capacity" of the coil. A general formula, equation (6), is derived for its calculation.

Single-layer Solenoid.—The formula is applied to the short single-layer solenoid, used when grounded in an elliptical shield and when insulated from the shield, and to the short single-layer solenoid used when grounded and insulated in free space. An explanation is given of the remarkable *constancy* of C_0 as found by experiment in the case of short coils.

Experimental Verification.—An experimental verification is given by direct measurement of capacity and inductance. The current distribution in a coil has also been studied experimentally. The results have verified the theory.—*Physical Review.*

ON THE PULSEN ARC IN COUPLED CIRCUITS.

By P. O. Pedersen.

A bibliography of oscillating arc investigations with coupled circuits is given. A special form of circuit, wherein the arc and the antenna circuit are coupled electrostatically thru an arc "series condenser" and a "shunt condenser," is studied analytically. Experimental results on the same circuit are given, and the practical usefulness of the circuit is discussed.—*Proceedings Institute of Radio Engineers.*

EQUIVALENT CIRCUIT OF THE VACUUM TUBE MODULATOR.

By John R. Carson.

The author starts from the consideration of the equivalent circuit to a three-electrode vacuum-tube amplifier. He then derives mathematically the equivalent circuit of a three-electrode vacuum-tube modulator. The resulting theory is applied to a practical example in modulator design and its usefulness demonstrated.—*Proceedings Institute of Radio Engineers.*

ELEMENTARY INFORMATION FOR RADIO AMATEURS.

A list of periodicals and elementary books covering radio information for amateurs. The publication also contains suggestions regarding radio-communication laws and call letters for radio stations in the United States.—*Publication Radio Laboratory, U. S. Bureau of Standards.*

FOTO-ELECTRIC EFFECT IN AUDION BULBS OF THE OXIDE-COATED-FILAMENT TYPE.

By Theodore W. Case.

A record of the discovery of foto-electric effects from certain oxide-coated filaments of some high-vacuum Western Electric audion bulbs. Calcium, barium and strontium oxide cells were made, the two last named being principally worked with. The foto-electric current is proportional to the light intensity. The current for average sunlight is 100 to 150 micro-amperes. This is sufficient to run recording ammeters and thus furnish a curve of daylight intensity.—*From paper presented before American Electrochemical Society.*

SPECIFICATIONS AND CHARACTERISTICS OF MOORHEAD VACUUM VALVES.

By O. B. Moorhead and E. C. Lange.

A number of types of Moorhead tubes are

described, together with the mode of testing them and the specifications to be met. The tubes obtained are classified as detectors or amplifiers, which types the authors regard as separate and generally non-inclusive. The effects of small variations in a number of the tube dimensions are exhaustively studied, and conclusions are drawn as to the effect of varying the various tube dimensions.—*Proceedings of Institute of Radio Engineers.*

CARRIER CURRENT TELEFONY AND TELEGRAFY.

By E. H. Colpitts and O. B. Blackwell.

This paper briefly outlines the history of the development of carrier multiplex telegraphy and telephony. The fundamental principles underlying particularly the newer developments of the art are then discussed. Consideration is likewise given to the propagation characteristics of open-wire lines, including those containing intermediate

Radio Articles Appearing in the August Number of Science and Invention

Airplane or Battleship—Which? By Graser Schornstheimer. With special two-page illustration showing details of the radio control system on the battleship "Iowa," used in airplane bombing test.

Overcoming "Static" and Radio News Reception. By Arthur H. Lynch.

Radio on Your Vacation—How to Rig Up Your Kite and Also Tree Antennae. By J. L. Arthur.

Resonance Wave Coil Antenna. By J. A. Mauborgne, Major, and Guy Hill, Capt., U. S. Signal Corps. Specially written article complete with diagrams and fotos, never published before.

The August number of *Science and Invention* contains extra large "Constructor" and "How-to-Make-It" Departments in which many novel and clever ideas valuable to radio enthusiasts will be found, including "Question and Answer Box" and also "Patent Advice Column."

lengths of cable. Commercial types of apparatus and actual installations are described and a brief statement is made as to further applications of the art.—*Journal A. I. E. E.*

THE WAVE FRONT ANGLE IN RADIO TELEGRAFY.

By L. W. Austin.*

*U. S. Naval Radio Research Laboratory.

One of the outstanding problems in radio telegraphic transmission is the determination of the angle between the advancing wave front and the earth. A number of physicists have treated the subject theoretically and a resumé of their conclusions may be found in Zenneck's "Wireless Telegraphy" (translation 1915), pp. 246-253. The subject is of great importance in the theory of transmission and has a very practical interest in the reception of signals on ground antennae.

Several experimenters have attempted to measure the wave front angle by means of receiving loops, the method being to rotate the loop around a vertical axis to the point of minimum signal and then to rotate again around a horizontal axis in the plane of the wave front until silence is obtained. A little consideration shows that this method

is not applicable to the problem, since after the minimum is obtained by rotation about the vertical axis, none of the magnetic lines of the wave can thread the loop, no matter what its angle in reference to the wave front, any residual effect in this position being due to the action of the loop as an antenna.—*Abstracted from the Journal of the Washington Academy of Sciences.*

RADIO OFFICERS WANTED.

An examination similar to that held in April of this year will be held in August, for the appointment in the grade of Second Lieutenant, Signal Corps, U. S. Army.

The competitive examination will be held beginning August 22, 1921.

Candidates must be graduates, or members of the senior class, of educational institutions maintaining four-year courses of instruction in electrical engineering and physics and conferring the degree of bachelor of science in these two courses. Upon receipt of reports of examining boards decision will be made by the Chief Signal Officer as to whether or not the institution and the course therein qualify for appointment in that branch of the service.

Full particulars relative to both the preliminary and final examinations may be obtained by writing to the Commanding Officer of the nearest military post, or direct to the Chief Signal Officer of the Army, Washington, D. C.

The Signal Corps offers an extremely attractive career for young men trained along electrical lines, as it combines the advantages of Army life which are common to all branches, with the opportunity for study and achievement along scientific lines. The advances in electrical communication are proceeding with an almost unbelievable rapidity and the Signal Corps is not only keeping abreast of these advances, but is making every effort not to follow, but to lead. Well equipped laboratories are maintained and constant work is being done in development, both in the laboratory and in the field, of better and better types of signaling equipment.

TRAIN DESPATCHING BY RADIO IN FRANCE.

The Nord system of French railways will be the first in Europe to install wireless telephones for the control of train movements. Work has already commenced on receiving antenna to be attached to a statue surmounting the Gare du Nord, the principal Paris station, and a special registering apparatus has been designed by M. Branly, whom the French consider to be the real discoverer of the possibilities of the wireless, in his little laboratory on the outskirts of Paris.

For the present, the system will only connect the Gare du Nord with individual stations as far as Creil with occasional intermediary sending posts attached to telegraph posts along the line, which will be useful in case of accident. As the efficiency of the system is proved, however, the company intends extending it as far as Dunkirk, with interstation service as well as long range despatching control.

Other French railways are watching the experiment with interest, as it is expected to make obsolete all block systems and to reduce the control costs by at least 75 per cent.

Meanwhile M. Branly is working quietly on various wireless inventions, which have been delayed by the war and thru lack of funds. It is more than likely that the French Government will advance 100,000 francs this year to enable him to continue his labors to contest Great Britain's wireless supremacy.

Improved Circuit for V. T. Supplied with A. C.

By U. H. BROWN

We've been handed "dope" on lighting the filament of receiving bulbs on A. C. current, but in every case I've noticed the "buzz" has not been eliminated, only diminished and smoothed out. Here is a circuit that eliminates the hum, but lets the signal thru very strong and clear.

The difference between this circuit and others is the plate and fones circuit.

The potentiometer P of a resistance of 1,000 or so ohms (ordinary grafito potentiometer O. K.) connected across the 6-V. lead from a step-down transformer with a variable contact connected in grid circuit, balances the potential to the grid, smoothing down the A. C. hum.

Now in the fone circuit we have an ordinary telephone induction coil Ti, the primary of which is in series with the plate circuit. The secondary of Ti has two very small stopping condensers of about .0005 or up to .001 mf. from each lead of the secondary,

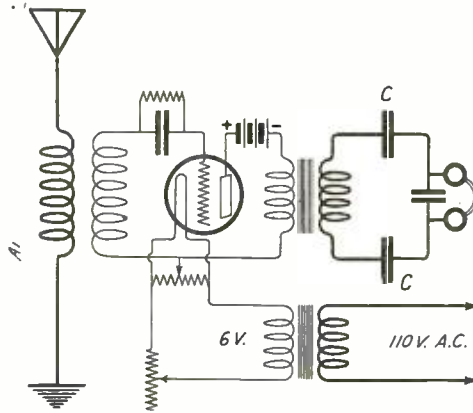

The Use of a Telephone Transformer and Condenser Cuts Out the Hum Heard When a Detector Tube is Supplied With A.C.

thence to the fones. This circuit constitutes a "real" filter circuit. Due to the fact that the iron core of the Ti acts as Hi impedance to the low cyclage current, very little of it passes to the secondary. What little hum gets thru is blocked by the small stopping condensers.

The Hi frequency signal goes thru the circuit with practically no diminishing of intensity. Result: a clear, strong signal, no induction buzzes.

I have used a modulation transformer in place of the telephone induction coil with practically the same results.

It will also be noted that lower ohmage fones can be used with this circuit if the Ti has a step-up ratio.

For continuous-wave reception, the plate circuit can be fed back to the grid circuit in the ordinary tickler coil circuit.

This may help some of the fellows trying to use A. C. for filament lighting purposes.

"A" and "B" Batteries Replaced by 110 Volts A. C.

By PROF. M. MOYE *

At first sight, my receiving set looks like an ordinary three-step resistance-coupled amplifier with retro-active coupling, but its special and still unique feature, I believe, is its working without any cell or battery, all electrical energy being taken from the lighting main.

I shall not describe the amplifier, which is of a well-known pattern, but I may, perhaps, emphasize that a tuned circuit is rigged up on the plate side of the last V. T. with a detector and telephone in shunt. This circuit, tuned to the incoming signals, rejects them on the detector and fones, while it allows an easy path to the troublesome noises of very low frequency (50 cycles per second) drawn up by A. C. use. These noises, therefore, leave the fones undisturbed and you get signals

exactly as by the time-honored method of accumulators or batteries.

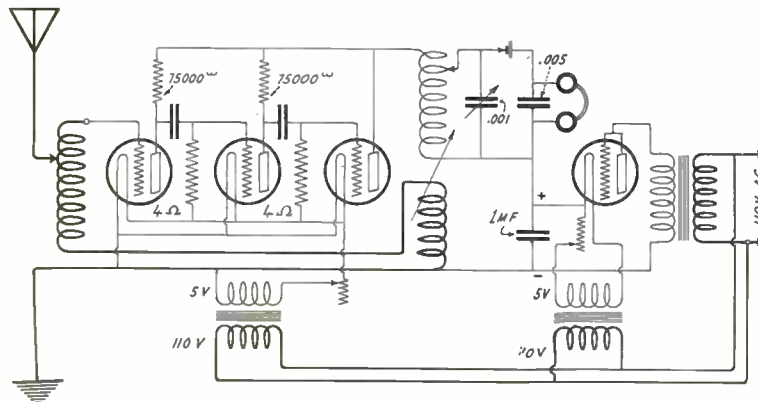

This Three-Stage Radio Frequency Amplifier is Supplied by A.C. Rectified Only for the Plate Voltage.

The heating of the filaments is obtained, quite easily, thru the secondary of a bell-

ringing transformer. The diagram is self-explanatory.—For the high-voltage on the plates, I devised a ready-made rectifying valve with an ordinary V. T. with grid and plate connected together as indicated in the illustration. The rectifying valve is lighted by another bell-ringing transformer and the cold electrode is fed with A. C. from a one to one transformer of fairly high resistance (300 to 500 ohms). A connection from the filament goes to the plate side of the amplifier and delivers the required voltage. A condenser of 1 mfd. is put across the terminals of the rectifying apparatus and smooths out the fluctuations of the rectified current while allowing path for radio frequency oscillations. No choke coil is necessary.

* University of Montpellier, France.

A Method of Measuring the Strength of Wireless Signals

By HATTO TAPPENBECK

The following apparatus, which can easily be made by every amateur, was successfully used by the Signal Corps of the U. S. Army during the war in France for measuring the strength of wireless signals.

The electromagnetic system consists of a permanent magnet (m) of horseshoe shape and is provided with several turns of wire on one pole (w). A magnet taken from a telephone is very convenient for the purpose and has to be mounted with the solenoid on the lower pole, as shown in the drawing.

A thin steel plate (r) is fixed on the upper pole tip very close to the lower pole; it should vibrate freely. Its length is tuned to a certain tone. The lamination has at the end a little mirror (c) which is connected to it by a silk ribbon (d).

If the radio-waves, which are received by the antenna, pass the solenoid (w), the magnet attracts the lamination (r) and makes it vibrate according to the received

signals. These vibrations turn the mirror (c) around the thin ribbon, which holds it. The stronger the signals the more the magnet is magnetized, and the more the small

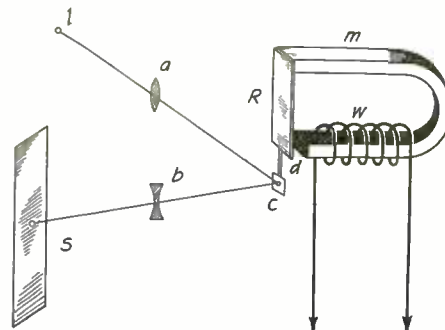

Here is a Simple Method of Measuring the Strength of Receiver Signals With an Apparatus Which May Easily Be Built.

steel plate vibrates, the more the mirror turns.

The rays of the light (1) fall thru a conversion lens (a) on the mirror and are reflected thru a diversion lens (b) in order to fall parallel on the scale (s) as a light-beam.

This light-beam must be on the zero-mark when the mirror is at rest. If, however, the mirror is moved by the radio signals the picture moves higher or lower on the scale, which should be at a distance of about 28 inches.

The strength of the signals is determined by the largeness of the deflection. Instead of a fixed scale, a moving one of sensitive fotografic paper may be used. The strength of the signals is then seen as a sinuous-line.

This simple apparatus is very sensitive and indicates even with sufficient accuracy the disturbances of the atmosphere caused by the static electricity.

Filament and Plate Voltage from 110 V.—D. C.

By FRED G. REIFENBERG

IN these days of regenerative circuits, two-step amplifiers and wireless telephone sets, with all necessary accessories, the amateur is liable to consult his pocketbook and then mournfully recall the days when a loose coupler and a piece of galena were the main essentials of his outfit. At that time, the first cost was practically the total expense, as the upkeep of such a set was practically nil. Compared with the modern amateur set of today in which replacing burnt out tubes, recharging of storage batteries and the buying of new "B" batteries, which are no small items, those were indeed the happy days. The battery question is probably the most troublesome and expensive one which the amateur has to contend with, and the purpose of this article is to give a method of reducing the cost of this item.

Every amateur who has used a vacuum tube knows that there is always more or less trouble and expense connected with the battery. Several descriptions have been published in RADIO NEWS for construction of "B" batteries and in the January issue, Mr. Reed gave a practical method of using A. C. for filament current. Up to the present, however, I have seen no description of how to use 110 volts D. C. for this purpose.

After a few experiments I found a method of reducing the current with the

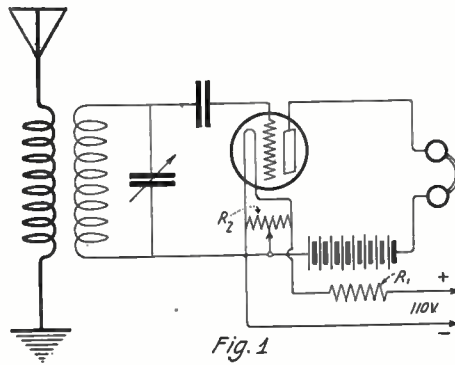

This Diagram Shows How to Use a 110-V. D. C. to Supply the Filament Current to a V.T. Detector.

current will pass thru it until resistance is added at R2. The current then has two paths to flow thru and as the resistance of R2 increases, more current will pass thru the filament until it reaches the proper brilliancy. This method is just the reverse of having the rheostat in series, in which case resistance must be cut out to increase the current.

The resistance should never be open circuited, as the full current will then flow thru the filament and probably burn it out. This connection will consume about two amperes.

The current consumption may be reduced by substituting resistances of higher value. R1 should have a value of about 125 ohms and a 100-watt lamp may be used for this purpose. R2 should then be of about 20 ohms, and the current consumption will be less than one ampere.

As the negative side of generators is usually grounded, care should be exercised in conductively coupled circuits where the filament is grounded. A condenser inserted in the ground lead will overcome this trouble.

Experiments have been carried on with this circuit with the idea of eliminating the "B" battery as well, with the result that both the filament and plate voltage can now be supplied direct from the line wherever 110 volts D. C. are available.

Referring to Fig. 2 it will be noticed that the circuit is practically the same as the one for "A" battery use alone, except that a tap is taken off at R3 to secure the plate potential by utilizing the voltage drop across R2. The resistance R1 may be the ordinary six-ohm filament rheostat connected as

shown, while R2 and R4 should have a resistance of 15 and 50 ohms respectively. R3 has a value of six ohms and is tapt at each end and in the center to secure a variation of the plate voltage. On the first tap on the left, the voltage will be 22, on the center tap 27, and on the last 32 volts. Higher voltages than this may be secured by increasing the resistance of R2, but this is accompanied by an increasing hum of the generator.

The three resistances have been shown separately for the sake of clearness, but they may all be combined in one unit with taps taken off at the proper points. A rheostat may be substituted in place of the switch at R3, thereby securing a very fine plate voltage regulation.

At Fig. 23 is illustrated a method of using lamps for securing the plate voltage in connection with the "A" battery circuit previously mentioned. B1 is a 100-watt lamp and B2 is a 25-watt size. R2 in this case would then have a resistance of about 75 ohms, or higher if R1 is also increased.

This circuit is not as efficient as the one illustrated in Fig. 1 for the reason that in the first circuit R2 has a resistance of only 15 ohms, while in Fig. 3 B1 has a resistance of about 125 ohms, thus increasing the resistance of the plate circuit. The efficiency can be increased somewhat by substituting

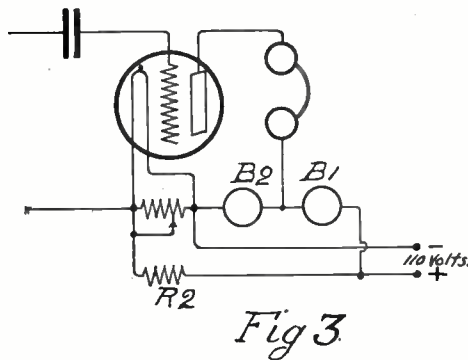

If the Plate Potential is Not to be Varied Carbon Lamps May Be Used as Resistances.

hum from the generator so slight as not to interfere with the reception of signals. Referring to the diagram, it will be seen that two resistances, R1 and R2, are used. R2 may be the ordinary six-ohm rheostat used for filament regulation and in that case R1 should be of about 60 ohms.

To light the filament, all of resistance R2 is cut out and the current then is turned on. As the filament is short circuited no

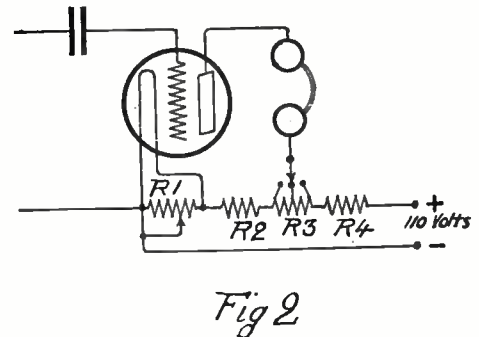

The Plate Voltage May Also Be Obtained From the D.C. Line.

a 200-watt lamp at B1 and a 50-watt at B2. In either case the plate voltage will be about 22, but this may be increased by using lamps of lower wattage at B1.

Using either of these circuits, the hum from the generator, even with a regenerative hook-up, is very slight. The hum will be a little louder at certain wave-lengths, depending on the length of the power line, but generally below 600 meters it is hardly audible.

Fone Reception Without Antenna

By HAROLD S. POTTER

WHILE trying out some simple hook-ups for receiving, I experienced considerable difficulty in tuning in fone stations to maximum audibility. There was also great interference from spark stations, so that successful reception was practically impossible.

Finally I tried the hook-up shown below and found it so satisfactory that I think some other "bugs" might like to try it. This system gives easy tuning for fone and C.W. stations. It gives louder signals on fone and C.W. work than a regular hook-up using a coupler, with an antenna, while it cuts out most spark interference.

Referring to the diagram, L is an inductance consisting of about 55 turns of No. 22 wire wound on a length of cardboard tubing 3 1/4" in diameter, tapt in eight

places. C1 is a variable condenser of .001 MF capacity, while the grid condenser, C2, is of .0005 MF capacity. A fixt grid condenser can be used, but a variable gives better results. The grid variometer can be

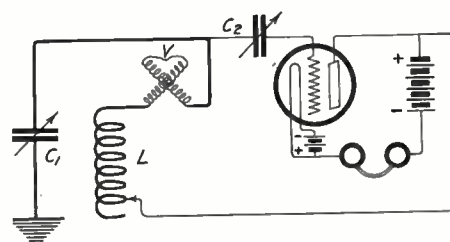

Here is a Simple Hook-up Which May Be Useful for Those Who Can't Erect an Aerial.

omitted if desired, but it helps in giving fine tuning. It is to be noted particularly that the + side of the filament is used as the common side.

The tuning is done with the top switch and condenser, while the oscillations are controlled by the grid condenser. The grid variometer, if included, helps in tuning. If an amplifier is used, it should be connected in the usual way, that is, the primary of the transformer in place of the fones.

This hook-up should prove of great service to those amateurs who are so situated that they cannot erect an antenna, since it gives better results than a small indoor antenna such as this class of amateur is usually forced to use. I would be glad to hear from any amateurs who try out this hook-up.

Who's Who in Radio

GENERAL G. FERRIÉ

No. 7

BORN Nov. 19, 1868, at St. Michel de Maurienne, France, General Ferrié entered the Polytechnique School in 1887, preparing his military career. He graduated from this school as an officer of the Engineers Corps.

He specialized in military use of telegraphy when he entered the Army in 1893, then he began the study of the new invention, wireless telegraphy, as soon as its practicability was demonstrated by Marconi in 1898, after which time he carried out extensive experiments to demonstrate its practical application as a means of communication for the Army.

After Marconi successfully sent a message across the Channel in 1899, the French Minister of War named General Ferrié as Chief of the Radio Section of the Signal Corps, which position he still holds at the present time.

STUDIES AND PERSONAL RESEARCHES

General Ferrié, trying to improve the detectors, invented in 1900 the electrolytic detector, which was in use for a long time after, as the most practical form of detector at the time. He had formerly tried to improve the coherers and had created a special model in which the quantity of metallic powder could be adjusted.

Later, he studied and carried out a great number of experiments on imperfect contacts. In 1901, General Ferrié and his staff determined the distribution of the field of an antenna by means of a receiver placed in a balloon, which could be moved in every direction at various altitudes. Researches were also made to find out the best means of obtaining maximum efficiency from an antenna and the ground connection.

Some further research work led General Ferrié to make a very complete study of the stationary waves in closed circuits, the results of which were used in the designing and construction of wavemeters.

In 1903, working with Mr. A. Blondel, General Ferrié began research work on directional radio and the use of loop aerials

for reception. Unfortunately, the lack of sensitive receiving apparatus prevented any practical results being derived from this work. However, as soon as amplifiers of the vacuum type were used, these researches were taken up again by the French Signal Corps and produced in 1916 the standard Military Radio Compass set, which

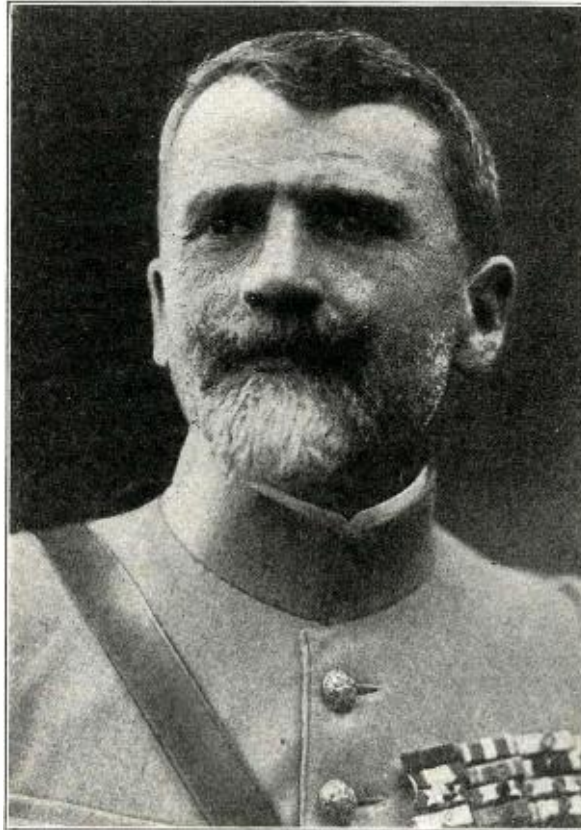

General G. Ferrié, Chief of the French Army Signal Corps.

has been extensively used since.

In 1905, General Ferrié and Mr. A. Blondel experimented with alternating current and its application in Radio telegraph transmitters. Different types of spark gaps were

also designed to be used in conjunction with Radio transmitters supplied with alternating current of industrial frequencies and in 1909 was begun the construction of the Eiffel Tower underground station under the supervision of General Ferrié.

In collaboration with Messrs. Claude and Driencourt, astronomers, General Ferrié created a very accurate method of comparison for the determination of longitudes, which method is used at the present time in every country.

From 1909 to 1915, General Ferrié developed what is known today as T.P.S., or ground telegraphy. This system, which in itself is rather simple, uses a buzzer and two ground connections placed far apart; using only a few watts, it is possible to communicate about three miles. Ground telegraphy was used during the last war by all the Allies of France and was even imitated by its enemies.

During the following years, General Ferrié solved several problems which arose in the construction of high power stations.

The first practical wireless communication established by the French Signal Corps was between Martinique and Guadeloupe after the earthquake had destroyed everything. This station, erected in 1902, maintained constant communication between these two points for a long time.

In 1910, when the airplanes and balloons began to be used for military purposes, General Ferrié designed and installed the first Radio station aboard a dirigible. During the Colonial War in Morocco in 1908, Radio was exclusively used to keep in constant communication the different Armies and Corps. Some small 300 watts, magneto type, spark sets were used as light units, and carried on horseback; these small sets proved to be very efficient throughout the campaign.

Not only did General Ferrié direct the Military Radio Corps, but also created the Radio Department of the French Navy, and began to install some powerful sets aboard the big warships.

One of the greatest creations of General
(Continued on page 160)

The Value of a Radio Operator

By CHARLES J. O'SHEA

TO a broad-minded person, the value of a radio operator aboard ship is never questioned. This, however, does not seem clear to a certain class, which thinks a person must engage in manual labor before he is entitled to receive pay for services rendered. It is to this class I dedicate this article, and will humbly endeavor to put before them the real value of a sea-going radio man.

First of all, let us consider his greatest duty, that of protecting the ship in time of peril by that concise but significant SOS signal. Think of the anxiety spared passengers, ship owners and marine underwriters, to know that their ships, if equipped with radio, will be guarded constantly against the elements of the sea. In time of need an SOS call will draw ships in the vicinity, and the ever vigilant Coast Guard cutters, to their assistance like a magnet. A radio man will stand by his set, hours at a time, to see a distress call thru.

Next in order of importance comes the

radio compass, an instrument highly developed during the World War, and is without doubt one of the finest aids to modern navigation. The use of this compass naturally makes the radio man what we might term the navigating officer's "right hand man," due to the fact that in bad weather, most officers rely on radio bearings to determine the ship's position. It is surprising to what degree of accuracy these bearings are given. A layman may judge for himself when an old salt who has sailed the Seven Seas before radio was even thought of, will permit his vessel to be piloted by the radio compass. These two above named duties of an operator should be sufficient to convince even the most skeptical, of the real value of a radio man.

Now comes the economic side, the actual amount which shipowners save, by equipping their fleet with radio. I need only cite the recent congestion at Ellis Island, where it was impossible to cope with the influx of immigrants; managers of various lines mere-

ly had to sit at their desks and dictate a message to be sent via radio to one of their liners, diverting it to a port where conditions warranted a more speedy way of docking, thus releasing passengers more quickly, and saving thousands of dollars, whereas if these liners were not equipped with radio they would cover hundreds of unnecessary miles, necessitating the use of tons of needless fuel, and extra meals to hundreds of passengers.

These are just a few of the major details that render an operator of value, not to speak of the hundreds of "love and kisses," birth and death messages he handles as regular ship's routine traffic, thus affording travelers aboard these ships the same efficient means of communication as tho on land.

When one thinks of the versatile character behind all this work, he can hardly begrudge the radio man his salary of one hundred and twenty-five (\$125.00) dollars a month and keep. Is he not worth it? Ask any maritime man. I assure you he will answer in the affirmative.

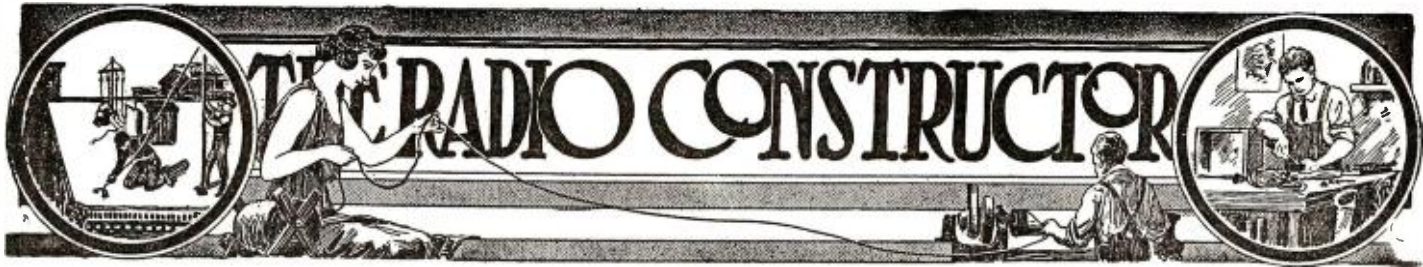

Construction of High Voltage Step-Up Transformer

By H. WINFIELD SECOR.

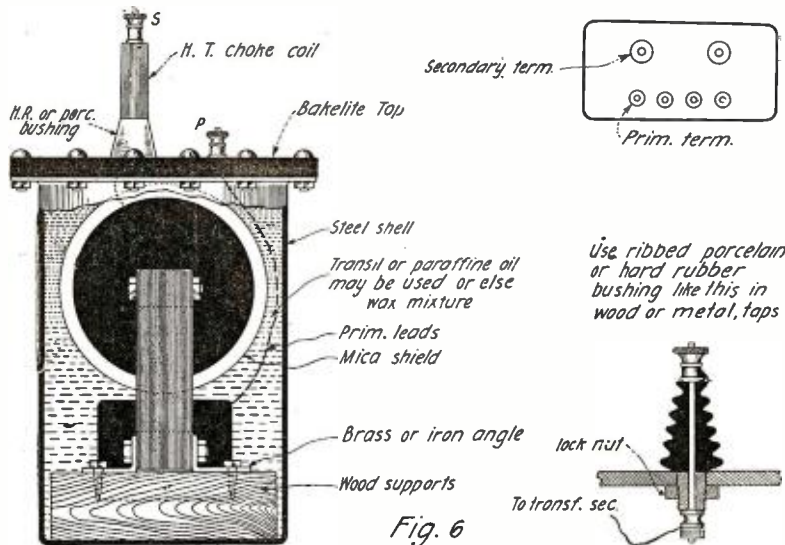

This drawing shows the inside view of an immersed transformer when completed, as well as the mounting of the H.T. terminals.

after the required number of layers have been wound. It is well to place a layer of oiled linen between each primary layer of wire, or in any case the primary should be thoroly soaked with molten paraffin wax or else pure orange shellac, and allowed to dry out before any current is passed thru the winding. Tap leads are taken off at the end of each layer, as shown in Fig. 2, to permit varying the secondary voltage and the amount of power passing thru the transformer. The lower the number of primary turns connected in circuit, the higher the secondary voltage. Also with a lesser number of primary turns in circuit, the greater the amount of power consumed in watts.

Several different schemes which have been successfully used in building transformer cores, are illustrated at Fig. 3. Several variations of the lapt corner for such cores have been used, but it is generally conceded that the best and most efficient core, magnetically speaking, is that shown at Fig. 3D, where the alternate sheet iron leaves, coming from the two core sections at a given corner, are interleaved and these corners held tightly together after the windings have been put in place by suitable clamps or bolts passing thru the iron sheets. Speaking from an engineering point of view, iron bolts should never be passed thru the sheet iron laminations nor holes bored thru the assembled laminae, as a waste of power is bound to result unless the bolt is carefully insulated with either brass or fiber and also providing the edges of the laminations are not all driven together and thus undoing the work which we have set out to do in the first place, by building the core of separate sheets instead of using solid iron bars. The author prefers some form of clamping device in every case for holding the cores tightly together. If the cores are not clamped very tightly together,

THE high-voltage step-up transformer has found extensive application in radio work and detail instructions are given in the following paragraphs for building a one kilowatt as well as a 1/2 kilowatt closed core step-up transformer giving a suitably high secondary voltage. These transformers are used also in high frequency experiments, and with a well built Tesla coil, excited by the one kilowatt transformer, it is possible to produce high frequency sparks 30" to 36" in length—a veritable roaring flame as big as a man's wrist. The half kilowatt transformer will produce high frequency sparks 15" to 18" in length when it is connected with a suitable high tension condenser such as a glass plate or other type and a Tesla coil of proper design.

lathe with a little ingenuity on the part of the builder and wound in this manner. Another way to wind the primary coil is to build

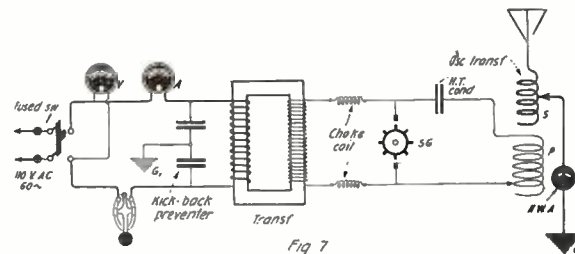

Here is the Complete Circuit of a Transmitter With All Necessary Apparatus.

DATA FOR 1 K.W. 110 VOLT TO 18,000 VOLT 60 CYCLE A.C. TRANSFORMER

The laminated sheet iron core for the one kilowatt transformer, shown diagrammatically at Fig. 1, has a length L of 15": a width W of 8 3/4", and the thickness T of the core is 2". About 41 pounds of transformer sheet steel will be required and many experimenters buy the soft Russian sheet iron procurable from tinsmiths or plumbing shops. The primary and secondary windings are wound on the two longer legs of the core. On referring to Fig. 2, the manner of assembling the iron strips for the core is clearly shown, the strips being staggered by reversing their arrangement in each successive layer. Both of the longer core legs should be thoroly insulated by wrapping 10 layers of 8 mil oiled linen (also called Empire cloth) tightly wound around them, as indicated in Fig. 2.

The primary coil may be wound over the oiled linen insulation on its respective core, by placing this core in an improvised winding jig so that the core can be turned with a crank handle, or it may be placed in a

a wooden form having a slight taper from one end to the other, and the primary coil is then wound on this form, and is removed

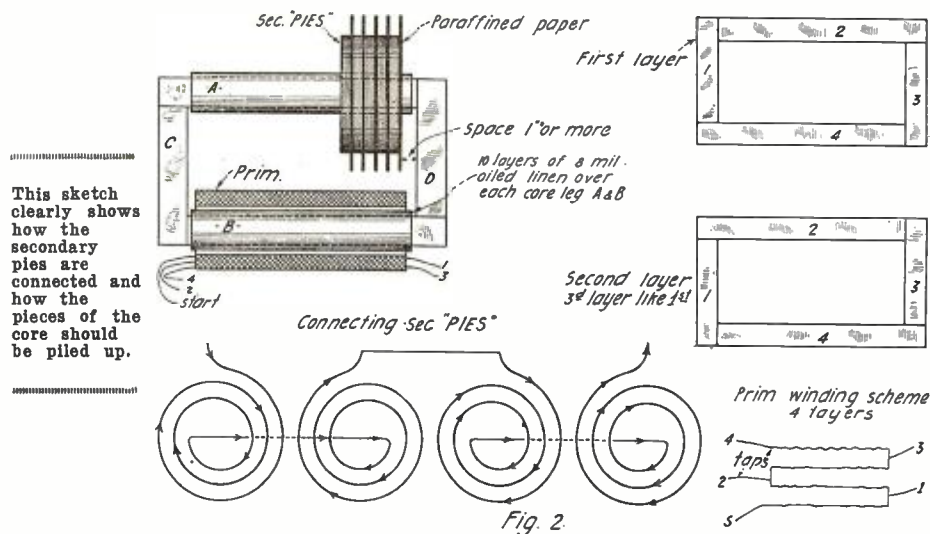

particularly at the corners where they are lapt or interleaved, there will be a considerable loss of power in the magnetic circuit and furthermore, there will be excessive humming of the transformer due to the vibratory movement of the loose core strips.

For the one kilowatt transformers the primary winding comprises four layers of No. 10 D. C. C. copper magnet wire. This is equivalent to 344 turns or about 12 pounds of wire. The length of the layer along the core is 10" and taps are taken from each layer, as aforementioned.

The secondary winding for this transformer will require about 12 pounds of No. 34 B. & S. gage, D. C. C. magnet wire. This wire is to be impregnated with paraffin wax before or during the winding process, and 24 pies or sections are required; each pie having 2,350 pounds; or the total turns for the secondary is 56,500 turns. Each pie will measure 1/4 inch thick, have an annular depth of 2" (see Fig. 1) and a core opening of 2.5" by 2.5". This is for an 18,000 volt secondary, with all primary turns in circuit.

For a 12,363 volt secondary, the winding should comprise 38,664 total turns or 1,611 turns per pie, No. 32 D. C. C. magnet wire being used. Details for winding the secondary sections will be given later on.

DATA FOR 1/2 K.W. 110 V. TO 15,000 V. 60 CYCLE TRANSFORMER

For this transformer the sheet iron core dimensions are L—14"; W—7"; T—1.4"; the weight of the iron core is approximately 20 pounds. The primary winding requires four layers of No. 13 D. C. C. magnet wire, which is equivalent to 480 turns or about 6 pounds of wire. The length of a layer of primary winding is 10 1/4", and taps are to be taken from the end of each layer.

For the 1/2 k.w. transformer, the 15,000 volt secondary winding will necessitate the winding of 8 pounds of No. 35 D. C. C. magnet wire into twenty-five 1/4" thick sections. Each section will have 2,630 turns, or the total turns will be 65,900. This will give 15,000 volts across the secondary circuit with all the primary turns in circuit. The secondary pies are to be 1/4" thick, have an annular depth of 2" and a core opening 1.9" by 1.9".

For a secondary winding to develop a lower potential, or in this case 11,908 volts, the dimensions of the sections will remain the same, but they have to be wound with No. 34 D. C. C. magnet wire, there being in this case but 2,092 turns per pie, or the total turns being 52,300.

WINDING THE SECONDARY SECTIONS

At Fig. 4, a simple form of section winder which has been used very successfully by

These curves are useful in designing a radio sending set in order to get maximum efficiency out of it.

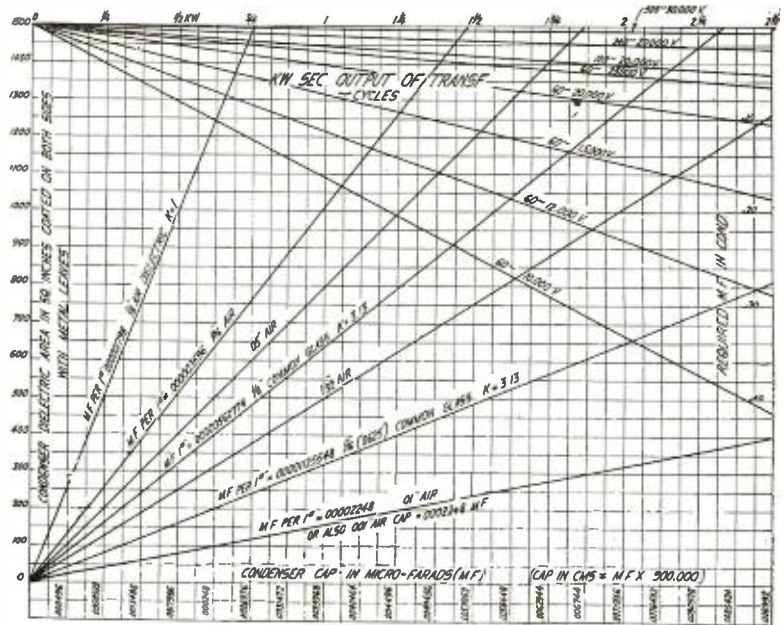
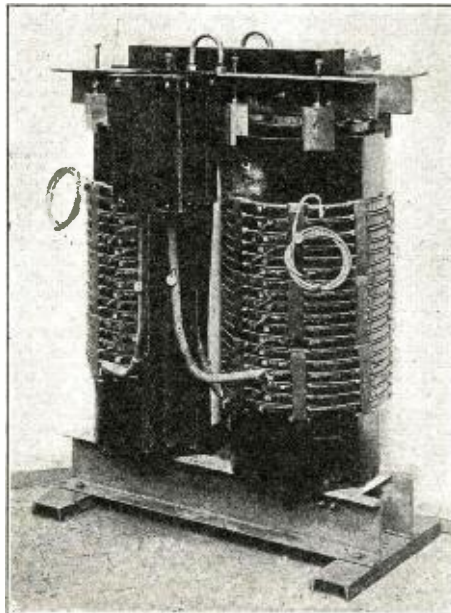

Fig 8



This Fotograf Shows Clearly How Pies Are Assembled and the Method of Mounting the Core.

the writer, is clearly shown. The revolution counter is not absolutely necessary unless

the design of a certain transformer is to be checked up, or where the builder may want to obtain the specified voltage very exactly, when of course the ratio between the primary and secondary turns has to be that given in the specifications for a given transformer.

There are two general methods of impregnating the fine magnet wire used in winding the secondary pies. The first method is to place the spool of wire, as received from the manufacturer, into a pail of sufficient depth to thoroly immerse it in molten paraffin wax, until all bubbles cease to rise; then by placing this impregnated spool of wire two or three feet above an alcohol lamp or Bunsen burner, as shown in Fig. 5, the impregnated wire will be found to build up nicely in the winding jig and no tape or other special means to hold the coil will be found necessary. The center wooden or fiber core of the section winder should be slightly tapered, of course, so that it will release easily from the core, when it is wound, but when the wing nut on the shaft of the winder is released and the two sides of the form are separated it will be found that the coil will hold together solidly; and also that it will readily separate from the wooden sides of the form, particularly if these have been shellacked in the first place when building the winding machine.

A second scheme for impregnating the secondary wire with wax is shown at Fig. 5, and here the wire is carried over and under a series of rollers—R, R, etc., the wax being melted in one pan or compartment, which is surrounded by water in a second larger pan; this method being the best to prevent overheating of the wax and a lowering of its insulating value.

By referring once more to Fig. 2, we see how the secondary sections which have been wound all in the same direction, are connected in the proper manner by reversing every other section in the assembling, in order that the current shall pass around the coils always in the same direction, as it must. It is very desirable if you want a good transformer that will not break down easily between the sections, to place oiled linen or else a heavy paraffin paper disk or two between every secondary section in the assembling, as shown in Fig. 2. Also spaces of 1" at least, should be left between the sections on either end of the secondary and the iron core, to prevent the high voltage from leaking or jumping across from the core and helping to break down the transformer.

The transformer may be mounted in a

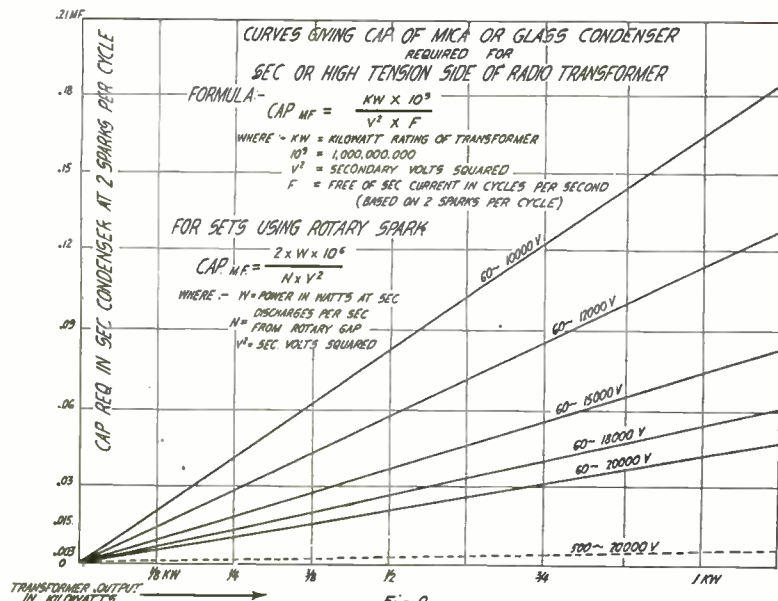
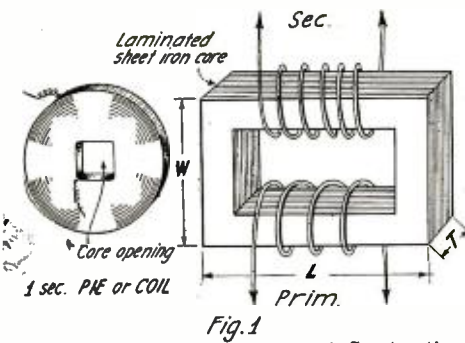

Fig 9

A useful chart to determine which capacity of H.T. condenser to use for a given power and frequency.



This Sketch Shows the Detail of Construction of a Section of the Secondary and How the Windings Are Mounted Upon the Core.

wooden or steel case somewhat in the manner shown for example, at Fig. 6. With a steel shell a very good insulating scheme is to use transformer oil or paraffin oil, and either a bakelite or sheet steel top can be used on the case. If the transformer is put in a wooden cabinet, it should be impregnated by filling the box with a mixture composed of 1 part beeswax, 1½ parts paraffin and 4 parts rosin, by weight. Heavy ribbed insulators should be employed for leading out the secondary terminals thru a steel top, but if hard rubber, bakelite or fiber is used, then the binding posts can be mounted directly on this material. It is a good idea to place choke coils on the secondary high tension terminals, these chokes comprising one layer of about No. 24 gage magnet wire wound on a porcelain tube about 4" long. Enameled wire may be used or even bare wire, spacing the turns a short distance apart.

A complete hook-up for a spark transmitter with rotary gap, is shown at Fig. 7, altho very good results have been obtained in several cases with which the writer is acquainted, by employing a quench gap. Many people will tell you that a quench gap is not worth while on anything else than 500 cycle current, but don't you believe it. Several years ago a ¼ kilowatt 8,000 volt transformer used in conjunction with a suitable Leyden jar condenser and a quench gap comprising eight .01" air-tight gaps with mica insulating rings and built by the Adams-Morgan Company, was successful in covering a distance of 120 miles and frequently a greater distance, in the Gulf of Mexico. Very tropical and severe conditions were, of course, encountered and as any radio expert can tell you, this means that this quench gap ¼ kilowatt, 60 cycle outfit employed as it was in conjunction with a variometer hook-up, similar to the Telefunken system—would have covered a distance two to three times as great in colder climates where the very severe static con-

ditions met with in the tropical regions are not encountered.

CAPACITY AND INDUCTANCE IN OSCILLATORY CIRCUIT

The accompanying graf, Fig. 8, will be found useful in designing and building high tension and other condensers, as by means of the curves there given, the necessary area of dielectric (both air and glass) to be charged by tinfoil or other metal coating, can be read off directly as well as the capacity in microfarads.

For example, suppose that from the graf, Fig. 9, giving the values of condenser capacities for various secondary voltages and transformer kilowatt ratings, we find that for a certain case .00449 microfarad capacity in the glass plate condenser to be used, is necessary. Locating this capacity value at the bottom of the graf chart in Fig. 8 and reading on a straight line upward, and providing we are going to use, let us say ⅛" thick common glass, such as window glass, we note the intersection of the ver-

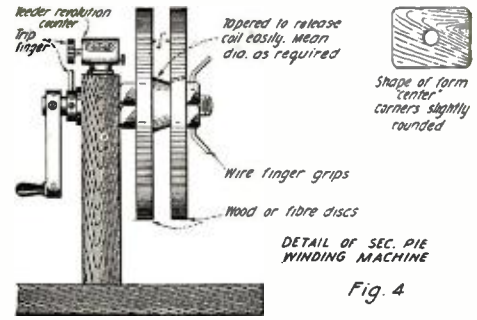

Such a Winding Machine Should be Built to Wind the Thousands of Turns of the Secondary.

tal line and find that 400 square inches of this dielectric, coated on both sides with tinfoil, will be required. This means 400 square inches of ⅛" glass, coated on both sides with metal charging leaves. Of course glass plates about 1" to 1½" or larger all around will have to be used in order to prevent leakage and breaking down of the condenser under the high voltage strain.

The graf, Fig. 9, gives the formulae as well as direct reading curves for finding the proper condenser capacity to be used in the oscillatory or spark gap circuit on all of the usual sizes of amateur radio transformers and also for the usual voltages met with in this work. A formula is there given also for determining the condenser capacity for rotary spark gap sets and it is interesting to note how the capacity decreases as the frequency is raised; note, for example, the very small capacity required for a one kilowatt transformer at 500 cycles, 20,000 volts, as compared to a one kilowatt 60 cycle, 20,000 volt transformer.

As regards the amount of inductance to be used in a 200-meter transmitting set, this should never be so small but that at least one complete turn in either the primary or secondary coil of the oscillation transformer should be in circuit, and never less than one turn. As the wave-length of this circuit is equivalent to 59.6 x VLC, we see that by decreasing the capacity of the condenser that the inductance can be increased.

It will be further observed that as the capacity of the high tension condenser to be used varies inversely as the square of the secondary voltage, it is quite necessary in building a short wave or 200 meter transmitter, that the step-up transformer employed should give preferably not less than 13,000 to 14,000 volts and that a somewhat higher voltage, will permit of using a smaller condenser and thus a greater value of inductance in the primary of the O. T.

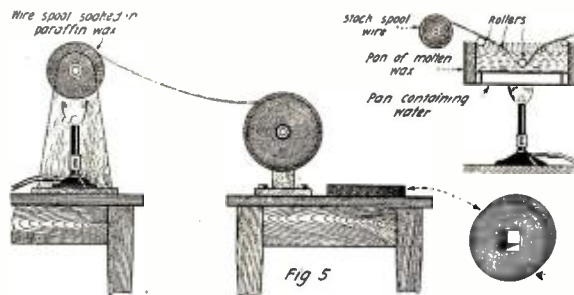

This Drawing Illustrates the Process of Coating the Secondary Wire With Paraffin Wax—and the Mounting Which Should be Made to Wind the Pies.

tical line with the corresponding diagonal line for this particular dielectric; from this intersection we read across on the horizon-

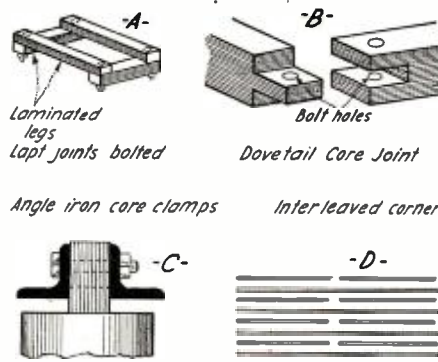

Details of Assembling of the Iron Core.

Labor-Saving Tables

By FREDERICK J. RUMFORD, E. E.

I HAVE found that when it is necessary to make tuning coils, loose couplers, electro-magnets, choke coils or most coils of any kind that are wound around a form or core, it takes a lot of valuable time to calculate the circumferences and areas, but the table given here will save a lot of valuable time. A glance at the tables will determine the amount of wire necessary for one turn around a tube or core of a given diameter. Using this table along with the one that was published in Science and Invention for February, 1920, on page 1022, by Mr. E. T. Jones, entitled "Time Saving Wire Tables," the experimenter can readily determine the number of turns, inches and feet of wire necessary to do the job.

These tables have been calculated in 1/10" and the experimenter can get ¼" and ⅛", by a simple division of any one of the given tables.

Any one of these four formulae make it possible to find area: Multiply the circumference by ¼ of the diameter; multiply the square of the diameter by 0.7854; multiply the square of the circumference by .07958, or multiply the square of ½ the diameter by 3.1416. To find the circumference, multiply the diameter by 3.1416, or divide the diameter by 0.3183. To find the diameter, multiply the circumference by 0.3183, or divide the circumference by 3.1416. To find the radius, multiply the circumference by 0.15915 or divide the circumference by 6.28318.

The tables are as follows:

Area	Diam.	Circum.	Area	Diam.	Circum.
.007854	.1	.31416	29.2247	.1	19.1687
.031416	.2	.62832	30.1907	.2	19.4779
.070686	.3	.94248	31.1725	.3	19.7920
.125664	.4	1.25664	32.1699	.4	20.1062
.197352	.5	1.57080	33.1831	.5	20.4204
.282744	.6	1.88500	34.2119	.6	20.7345
.384852	.7	2.19916	35.2565	.7	21.0487
.502668	.8	2.51332	36.3168	.8	21.3628
.636176	.9	2.82748	37.3928	.9	21.6770
.785400	1.0	3.14164	38.4845	1.0	21.9911
.950300	1.1	3.45580	39.5919	1.1	22.3053
1.131000	1.2	3.76996	40.7150	1.2	22.6195
1.327300	1.3	4.08412	41.8539	1.3	22.9336
1.539400	1.4	4.39828	43.0084	1.4	23.2478
1.767100	1.5	4.71244	44.1786	1.5	23.5619
2.010600	1.6	5.02660	45.3646	1.6	23.8761
2.269800	1.7	5.34076	46.5663	1.7	24.1903

(Continued on page 158)

Mechanical Interrupter for D. C. Transmitter

By A. GREENBERG

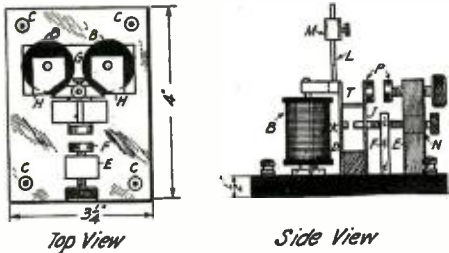
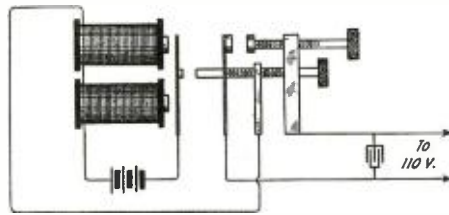

The Upper Sketch Shows the Diagram of Connections of the Interrupter, While the Lower One Shows the Instrument Completely Assembled.

THIS interrupter will be a boon to amateurs who have to use direct current for transmitting. The total cost of this interrupter should not be over two dollars, as most parts can be found in the junk box.

First get a pair of four ohm telegraf sounder magnets and drill a hole in the center of the magnet cone ends and thread with an 8/32 tap. Fasten on the pole pieces, which are made of 1/4" soft iron, as illustrated, at H. Make an iron yoke, G, 2 1/2" x 1/8" x 1/4", which connects and supports the magnets.

The base, A, should be 4" x 3 1/4" x 1/2" bakelite or formica.

The armature, I, is 1 1/4" x 1/2" x 1/4"; it is fastened to the spring with two short 8/32 machine screws.

The springs J and K, are 2 3/8" x 1/2" x 3/32" and may be made of either spring steel or brass. They must be insulated from each other by using a bakelite bushing on the screw, T, or by making T out of bakelite rod if possible. The hole in J must be large enough for the screw to pass thru without touching.

The contacts P, are made of tungsten or silver and are 1/8" x 1/8". One is fastened to the spring J, with an 8/32 screw and the other is tapt and screwed on to the 14/20 screw. The contacts on K and J may be made of ordinary contact points.

The piece D, which the springs are fastened on to must be made of bakelite or formica.

The top rod running thru E is a 14/20 screw, with the head cut off and a 1" bakelite knob put on; on the other end you put the large contact. The rod running thru E and D is an 8/32 screw with the head cut off and a 1/2" knob put on. Put an ordinary contact point on the other end.

The brass standard E, must be carefully insulated from the 8/32 screw by the bakelite bushing at N.

The sliding weight M is made of 3/8" brass rod 1/2" long and a 3/32 hole thru the center and a 6/32 hole tapt in the side. Raising or lowering the weight decreases or increases the period of vibration.

A large condenser should be shunted across the large contacts P to reduce sparking. This condenser may be made as follows:

Take 50 sheets of heavy tin foil 5" x 6",

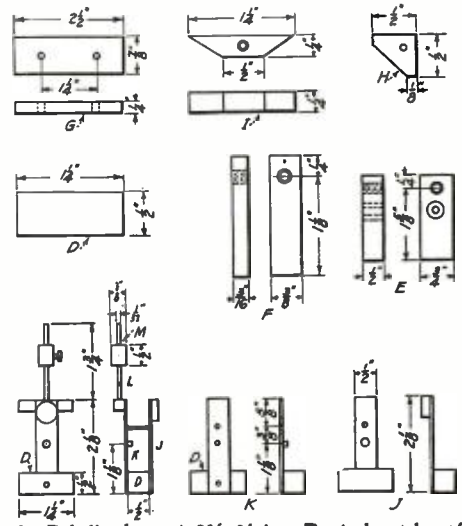

A—Bakelite base, 4x3 1/4x1/2 in. B—4 ohm telegraf sounder magnets, 2 are required. C—4 large binding posts. D—Bakelite 1/2x1/2x1 1/4 in. E—Brass 2 1/4x1/2x3/4 in., 1 hole tapt with 14/20 tap, other hole 3/8 in. F—Brass 1 3/8x8/16x3/4 in., 1 hole tapt with 8/32 tap. G—Iron 2 1/2x3/4x3/4 in., 2 1/2 in. holes. H—Iron 1/2x1/2x1/4 in., 1 1/8 in. hole, 2 pieces required. I—Iron 1 1/4x1/2x3/4 in., 1 1/8 in. hole tapt with 8/32 tap. J—Brass or steel 2 1/4x1/2x1/82 in. K—Brass or steel 2 1/4x1/2x1/82 in. L—Brass rod 8/32 in. M—Brass rod 3/4x1/2 in. with 3/32 in. hole. N—Bakelite bushing 1/2 in. diameter, 1/8 in. hole. P—Tungsten or silver contacts 1/2x8/16 in. with 14/20 in. tapt hole 1/2 in. in. T—4/82 in. brass screw with insulator at J.

The Complete Set of Parts With Their Dimensions is Shown in This Diagram.

alternate them with sheets of heavy paraffined paper 7" x 8". When the condenser has been assembled warm slightly and press (Continued on page 140)

Double Speed Key

By PAUL G. WATSON

The main advantage of the double speed key described below is the ease with which a heavy amount of traffic can be handled, and the peculiar rhythm of the sending, which is very pleasing to read.

The key should be assembled on the base, of bakelite, or if not available, hard wood will do. It is quite important in drilling the holes for mounting the parts on the base that they be spaced accurately. Error in this will prevent the contacts from meeting squarely.

The lever post, with the deep slot across the top and two countersunk holes should

be placed in hole "A" on the base after the spring brass lever is riveted in its place. The lever should be fitted in the slot in the post, before mounting on base, and firmly riveted in place with two copper rivets, and the heads filed down to the surface of the post. The silver contacts on the key lever should also be soldered in place before the parts are put on the base. Care should be taken in filing up the surfaces of the contacts to see that they are parallel and are properly placed.

The square washer shown in the detail drawing is to be placed under the lever

post, on the upper side of the base, and an ordinary brass washer should be placed in the counterbore before tightening up on the 1/4-20 nut, which should be screwed on the column.

The two contacts should then be soldered on the large end of the contact screws, and must be filed square with the center line of the screw, if the contacts are to come together accurately with the lever contact. The posts for holding the contact screws are square and should be mounted in holes "B" in the base, with the screw holes in the line. It is best to put the contact screws on the base, as it will avoid bending the lever. The two locknuts for the screws should be knurled, but a plain nut will serve in the absence of the proper ones.

After all the metal parts are in place the bakelite knob or handle should be fastened in place. The two holes in the bakelite should be slightly countersunk so that when the soft copper nuts are put thru the bakelite and the brass, they can be filed flat.

With some practice, a great saving of the operator's arm will be gained with this key and a good readable "fist" will be developed, if careful.

In addition to the material above, live, heavy binding posts should be placed on the base for connection. Grooves for wiring should be cut in the under-side of the base.

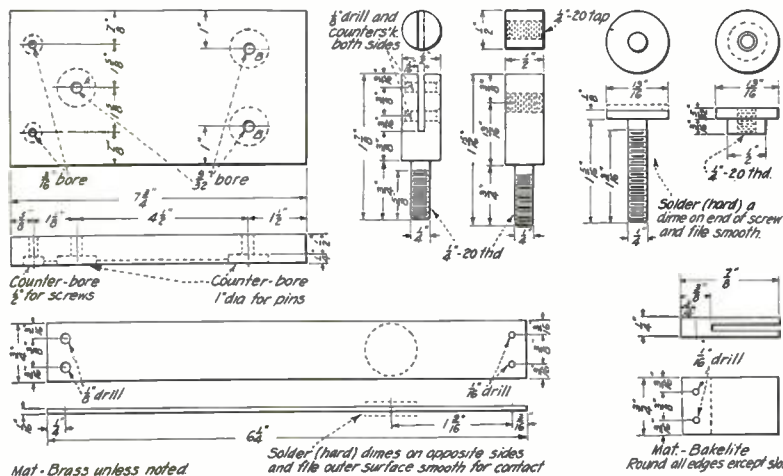

Details of parts used in the double speed key designed by Mr. Watson. This is the real thing for speedy traffic.

When Romance Meets Up With Science

By HAROLD VAN RIKER

DUSK had enveloped the Overland Limited. The train de luxe, on the first lap of its swift run across the Continent, was slowing up for the short stop at Nevada City.

Inside the Radio compartment, "Speedy" MacReynolds, a smouldering pipe drooping from his mouth, was carefully checking over a stack of messages which he would have to send as soon as the train got clear of the town.

It was a habit of Speedy's, to look over everything he had to send before schedule time, so that he could run thru the stuff at his characteristic pace, and his pace was a rapid one; his contemporaries had dubbed him "Speedy" on account of it.

In a nearby compartment, two stern parents, Mr. and Mrs. Porter Brown, were bestowing stern frowns upon their sulking daughter, Anita Brown.

Papa Brown had just snapped the lock on the compartment door, as he had carefully and persistently done at every stop of the Limited, and Anita, being something between seventeen and twenty, pretty, and red-blooded by inheritance from her stalwart forbears, did not like being locked in and made a prisoner of by any one.

"If you lock me in, I'll jump out of the window," spurted the girl in a pout.

"Mother, watch her. She might," growled Mr. Brown.

Mother Brown was visibly worried.

"That young scapegoat," continued Mr. Brown, "seems to have her hypnotized."

Mr. Brown referred to Mark Jennings a vigorous and ambitious young man who, in reality, deserved the title of Scientist.

A second attempted elopement of the pair had been nipped in the bud by the elder Browns some 12 hours previous, and Mr. Brown, being a man who thinks and does big things at the same time, had decided that the Eastern Coast of the United States was a better place for his daughter than the ranch in the famous Valley of the Moon.

Plans had been quickly formulated and Anita was taken aboard the Limited just before noon, and they were on their way.

After the brief stop at Virginia City, the train crept out and rapidly gained speed.

Papa Brown unlocked the compartment door and sat down to enjoy a respite from his vigilance.

Anita had lapsed into a deeply thoughtful mood and was gradually losing the pout from her lips. Had Mr. and Mrs. Brown not been a trifle inexact as to eyesight, they would have perceived cunning lights playing in the girl's eyes.

Queer, how the young can outwit the old.

"Surely, I can at least go into the observation car for a while," ventured Anita, good naturedly, yet re-suming enough of her pout so as not to arouse suspicion.

She read half-willing consent in her father's eye and sauntered out.

"Do you think it's safe?" asked Mrs. Brown.

"Of course," replied Papa Brown. "She's not foolish enough to leap from a train moving at 60 miles an hour."

And Papa Brown chuckled, as one who has won in a battle of wits, and tastes the honey of satisfaction.

"I wouldn't be so bad," he mused, "if the fellow was only worthy of her. But he's too darned cock-sure and he doesn't respect us or he doesn't even consider us and he's not going to get away with it!"

"Do you think he is likely to come East?" peeped timid Mama Brown.

"Naw! He's beaten. We'll keep Anita moving around so much and so unexpectedly they won't be able to hitch."

In the corridor, Anita had paused at the door of the Radio compartment. She stood smiling down at Speedy, who was clearing up the last of a pile of traffic collected from the passengers.

Her smile was that of a comrade in arms. She glanced about cautiously, stepped inside, and pulled the door shut behind her.

"I'm 9XV, and I know you're Speedy MacReynolds; I've listened to you lots of times. Got an outfit on the ranch near Schellville. I want to ask a favor of you and I've got to act quickly!"

Speedy was amused. He talked as he made the sending-key rattle under his nimble fingers.

"Don't usually monkey with amateurs," he commented, "but this is one grand exception. I'll be with you in a minute."

Anita glanced at the clock on the bulkhead. It registered exactly seven o'clock. She peered cautiously out into the corridor, came back and again closed the door.

She then deftly took in the Radio equipment with sweeping glances while Speedy finished his work with the San Francisco station.

"Can you get down to 200 meters?" asked Anita hopefully.

"Sure," Speedy informed her, reading the flaming anxiety in the girl's eyes.

"Then please do so, quick—and let me sit in. I've got to get in touch with 9SY right now, about something as important as life and death itself!"



"Can You Get Down to 200 Meters?" Asked Anita.

Quick, fix it up for me—please!"

The way she said "please" made Speedy forget all about the rules and regulations in his official Blue Book. He shifted from 1,000 meters to 200 meters in a few seconds.

"Go to it, Miss. You're as welcome as the flowers in May, and I'm glad to help you out," said Speedy lightly. "It's yours for 10 minutes."

Now, Anita knew that Mark, her co-partner in schemes to outwit the opposition of Papa and Mama Brown, would be listening for the familiar note of the set he had presented to her and installed for her at the Brown ranch, even if their previous plans had been shattered. A little after seven o'clock was the usual time that Mark sent out the "9XV" to which Anita was always waiting to respond.

There had always been something in the dots and dashes emanating from Mark's station in San Francisco besides mere letters and words. And that same evasive something could always be gleaned by Mark from the signals he received from Anita.

Mark had coached Anita in the sciences for a year, just for the fun of her companionship. Now this teaching was about to bear fruit in the way of real accomplishment.

At exactly 7:07 Anita sent with the powerful radiation of the Overland's radio plant the plaintive "9SY" to which Mark must answer. Yes, he *must* answer, or all was lost. Anita knew it, and formed her letters carefully. And there was something more than mere letters in those frantic dots and dashes. There was the subtle appeal for rescue.

Speedy stood by in open but silent admiration. He admired the girl as a lovely feminine creation, as would any man, but he appreciated and admired her unusual skill at his own game as well.

There was an interval of silence. Speedy assisted the girl in setting a tune for 200 meters, then stood nearby, wearing a second set of head fones, in respectful, hopeful silence. He did not wish to see the girl disappointed, but he held a doubt.

Two minutes slipped by. No sound that might be 9SY. Anita frowned, almost fearfully. What if Mark should not hear the Overland, and what if she could not hear

(Continued on page 130)



Without Hesitation She Acted as Mark Directed, and Together at the Bottom of the Ladder They Swung Clear of the Train.

A Derelict of the Storm

A play in one Act

By CHARLES A. REBERGER

CHARACTERS:

CAPTAIN COLE OPERATOR GRUBBS
MATE LARSEN MR. GUY DOANE
DOANE'S WIFE AND CHILD

(THE oil tanker "Roamer" is fighting her way across the north Atlantic. It is the latter part of March . . . a northwest gale is raging . . . mountainous seas are running. The president of the Consolidated Oil Syndicate, his wife and little daughter are aboard the vessel, acting as passengers during the trip to Boston. It might be stated that the fleet of ships owned by this concern were all equipt with radio outfits, but not a single one was equipt with storage batteries for operating the set in the case of an accident while at sea, as the president (Mr. Doane) believed this would only be a foolish, unnecessary expenditure of the company's funds. It is this voyage which convinces Doane that human lives are far more valuable than money and he is given a few lessons in the importance of having reliable radio outfits aboard all his vessels.)

(Scene—Radio room of the "Roamer." The ship's transmitter and receiver are discernable. The wireless operator, Byron Grubbs, fones on his head . . . a worried look upon his face, is seated at the operating table. The wind can be heard howling and whistling outside the cabin.)

(At rise of curtain three bells strike up on the bridge and operator, yawning, consults his watch.)

Captain (coming into cabin—wearing a heavy southwester and big boots)—"Get a bearing from Cape Race, operator. Our compass is way off."

Grubbs (turning around lifts fones off his head)—"Will try, sir, but don't believe we can work him. This set is only good for three hundred miles."

Captain (anxiously)—"Heavens, man, try to get him. If we get caught in an ice floe it's good-bye for us all. We have run too far to the northward and according to the fall in the temperature of the water we are in the vicinity of icebergs."

Grubbs—"Can you give me our distance from Cape Race, Captain?"

Captain—"About four hundred miles. but it might be more or less. A compass bearing will give us our approximate location."

Grubbs—"Will try to raise him, Captain. but I am certain it will be impossible for us to work him." (Starts generator and using rotary gap calls the radio compass station at Cape Race and then listens for an acknowledgment.) "No answer, sir."

Captain—"Keep after him, Sparks, we must get a bearing; God only knows where we are." (Mate, wearing a southwester, rushes in.)

Mate (excitedly)—"Just sighted three large icebergs off the port bow, sir. Temperature dropt twenty degrees. Any further orders?"

Captain (becomes greatly excited and grabs Mate by the arm)—"Great Scott, man, we're caught in an ice floe." (Captain rushes out followed by the Mate.)

Grubbs (jumps up and looks out the port hole, but all is dark)—"Oh, if we only had emergency power! Suppose something happens. Help at my fingertips and unable to

HERE'S a new idea for our Radio Clubs. Next Time, when you give an entertainment, suppose you feature a little playlet similar to sample herewith. It should not be expensive to produce, and it can of course be altered to suit. Perhaps this first attempt will be the start of a crop of new Radio playwrights.—Editor.

get it." (He goes back to the table and puts receivers on.)

Captain (returning from the bridge and entering radio cabin)—"Get a bearing yet, Sparks?"

Grubbs—"Called him, Captain, but received no answer. Guess he can't hear us."



"You Murderer! Your Own Wife and Child You Are Killing With Your Own Hands."

Captain (angrily and now greatly excited, jumps around the cabin, throwing his hands in the air)—"Don't you realize there are lives at stake? What good is the d—n wireless set? You've got to get a bearing some place . . . get it . . . it's up to you, boy." (Exits.)

(Just as the Captain closes the door, a crash is heard. The vessel quivers from stem to stern . . . all lights flicker and then go out. Fire alarms are sounded . . . ship's whistle is sounded. Operator pulls out large flashlight and lighting same, lays it on the receiver so as to throw its rays around the room in the direction of the door.)

Grubbs (in a terrifying voice)—"My God! What has happened?" (Captain rushes in. As the door opens a lot of water comes into the room.)

Captain (pulling his hair)—"Operator! Quick, the 'SOS,' we've hit an iceberg. Send out this position." (Hands operator a slip of paper and waits.)

Grubbs (after trying to start generator, finds there is no power)—"Captain! . . . Captain! . . . There is no power and we have no storage batteries."

Captain—"What will we do for help? My God, man . . . we're lost." (He rushes out and just then Doane, with his wife and child clinging to him, half frightened to death, rushes into room.)

Doane (yelling like a half crazed person)—"Is help coming, operator? Is anyone coming to save us? My God! My wife . . . my child . . . try to save them."

Grubbs (jumping up from chair, which falls on the floor, he comes forward, pointing a finger at Doane's wife and child)—"You murderer! Your own wife and child you are killing with your own hands."

Doane (falling on his knees)—"Don't—Please . . . don't—not those words."

Grubbs (continuing)—"We are lost. Impossible to send for help just because you . . . trying to save a few dollars for your rotten firm . . . refused to put emergency power aboard for us. We're sinking and you are the murderer of us all. In this terrific sea we will go down in a few minutes. (He rushes to a locker and pulls out two life preservers and running back puts one on Doane's wife and child, who are clinging together.) "There are only two of them (turning to Doane) and it is up to you and me to make the best of it."

(Mate comes in holding three life preservers. Takes woman and child by the hand.)

Mate—"We'll stay afloat for a few hours, so get out of here and get ready to go in one of the boats." (Turns to operator.) "Sparks, can't you possibly do something? We're all relying upon you."

Grubbs (grasps Mate's hand)—"I will do something." (All leave except Grubbs.)

Grubbs (to himself)—"Our only hope. I'll try it." (He rushes out. Captain and mate can be heard giving orders to prepare the boats. Wind is heard whistling outside. Operator rushes back into room, several dry cells in his hands. Quickly he connects them together and then the buzzer on the tuner is connected into the circuit. Wires are then brot from the buzzer to the antenna and ground.)

Grubbs (clasping his hands together)—"God! For the sake of that child and woman . . . help us." (He sits at table and starts sending. The buzzer can plainly be heard. . . . SOS SOS SOS SS. ROAMER SINKING. HIT ICEBERG. RUSH AID. IN LATITUDE 49.22 NORTH . . . LONGITUDE 43.41 WEST. FOR GOD'S SAKE HELP US. WOMAN AND CHILD ABOARD.)

Grubbs (after listening for answer)—"Thank God, the little spark broke thru . . . they're coming." (He jumps up as Doane happens to come into the room.)

Doane (in a pleading way)—"Any help coming, operator?"

Grubbs—"Yes, but lucky for us this fellow happened to be listening in on whatever wave-length I was sending."

Doane (grasping his hand)—"Thank God!" (He goes out, but immediately the Captain comes in accompanied by Doane and his wife.)

Captain (getting vessel's position from Grubbs, looks at it)—"They should be here within three hours." (Hurriedly exits.)

Doane (taking Grubbs by both shoulders)—"My boy, you have taught me a lesson. I'll never forget it. I never knew what it was to go to sea." (Turning to his wife.) "Let's go, Ann."

(Curtain.)



THIS Department is open to all readers. It matters not whether subscribers or not. All photos are judged for best arrangement and efficiency of the apparatus, neatness of connections and general appearance. In order to increase the interest in this department, we make it a rule not to publish photographs of stations unaccompanied by a picture of the owner. We prefer dark photos to light ones. The prize winning pictures must be on prints not smaller than 5 x 7". We cannot reproduce pictures smaller than 3 1/2 x 3 1/2". All pictures must bear name and address written in ink on the back. A letter of not less than 100 words giving full description of the station, aerial equipment, etc., must accompany the pictures.

PRIZES: One first monthly prize of \$5.00. All other pictures published will be paid for at the rate of \$2.00.

9. A. J. A

THIS MONTH'S PRIZE WINNER

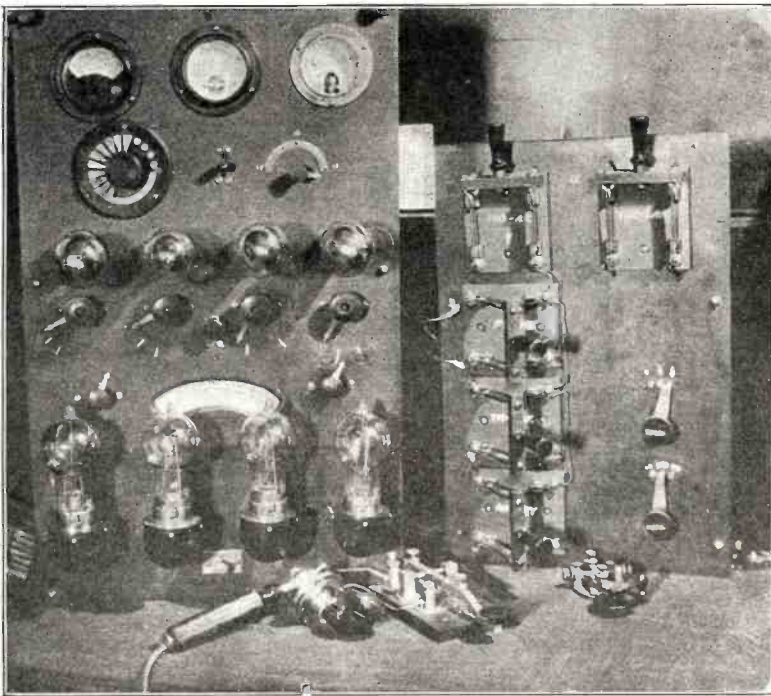

Here are two views of my Radio station which I would like to enter in your monthly contest.

The antenna is a four-wire L 35' high and 70' long, with a spread of 30'. The lead in fans down to within 3' of the O. T. Ground of buried metal as well as piping thru the house.

The receiver consists of C. R. L. paragon and two-step amplifier, Faldies and Magnavox, also a separate cabinet for honeycomb coils, which cover the entire wave range. These coils are all calibrated from a wave meter, so I am able to tell what wave a man is working on with very little trouble.

The transmitter is a four-tube C. W. set using two 200-watt Acme transformers and DeForest rectifying tubes. I get about 2 1/4 amperes in the aerial from U. V. 202 tubes when both transformers are connected, and that gives me a plate voltage of 1,200, and the tubes use about 250 milliamps. With one transformer and plate voltage of 600 radiation is about 1 1/4 amps.

The greatest reported range so far is ITS. Am able to work 300 miles with ease on a good night.

The spark transmitter is a 1/4-k.w. Acme transformer with Murdock moulded condenser, rotary spark gap and pancake O. T. Greatest reported range of this set is 5XB. It is not as reliable as the C. W. for rais-

.....
If El. does not get D.X. stations with such a receiver it is because he is asleep; but do you realize the feelings of we "crystal bugs" when we see a set like this!
.....

ing DX, apparently being more affected by freak conditions. The C. W. set has not been in operation during the good Radio weather, but I expect to do better next year.

The small center panel has all switches for control of power, making a quick come-back possible. As well as having all controls handy, this makes for neatness.

Fairly good results are had from the receiving equipment.

ELDEN F. HORN, 9AJA,
1321 Newport Ave., Chicago

.....
Oh boy!
Look at this C.W. and fone panel set. Isn't it grand?
.....

6. J. D

LOS ANGELES, CAL.

Here are two views of my station. The first one shows the receiver which is home-made and consists of a regenerative receiver and a detector with a two-step amplifier, built in separate units. Mounted onto the table are some tuning condensers and the telephone block.

The other fotograf shows the transmitter which has been designed for maximum efficiency; the leads are as short as possible and the primary of the oscillation transformer consists of the connections from the rotary gap to the condenser.

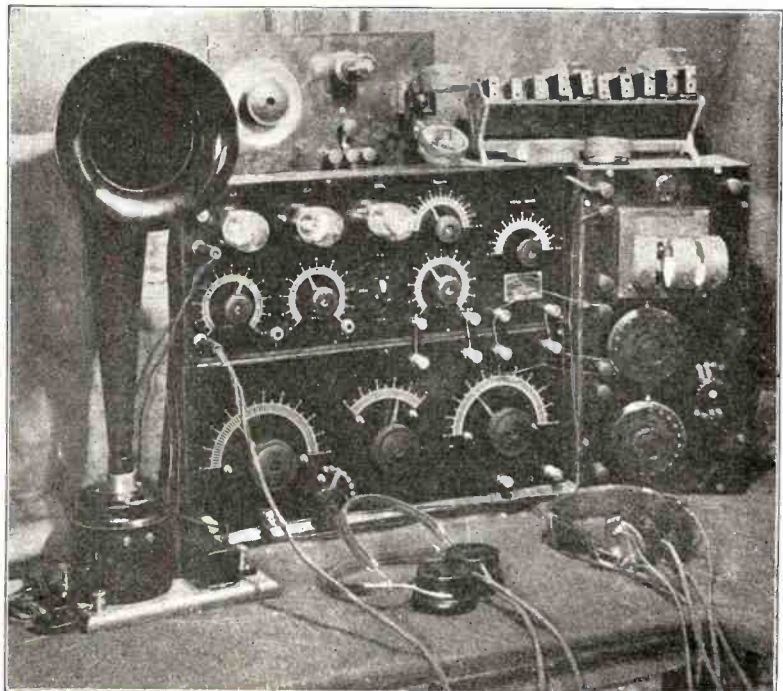

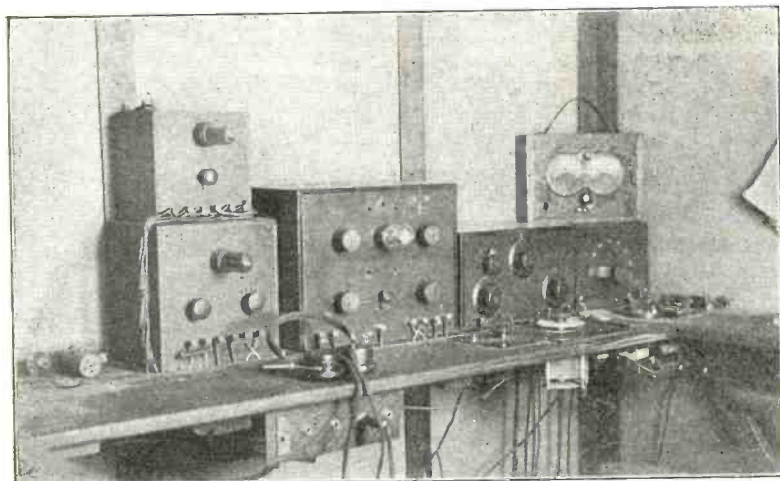

Here is an entirely home-made station which is really efficient. We extend our compliments to the owner of 6JD.

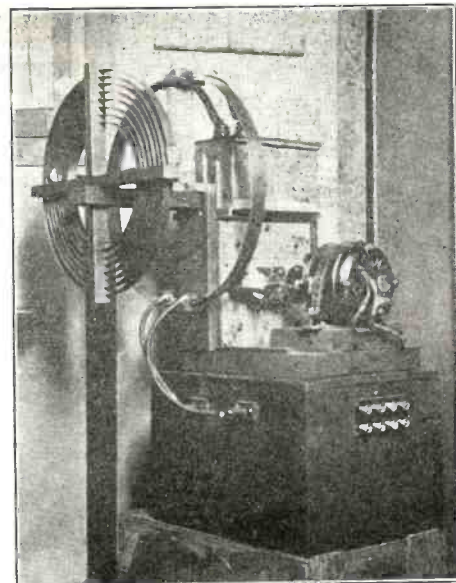

A proof of the efficiency of this transmitter is that the signals have been reported QSA by stations at more than 2,500 miles away.

During the Transcontinental relay, 6JD was the terminal station of the Pacific Coast.
V. M. Brz,
825-53rd St., Los Angeles, Cal.

J. L. Leistra's Station

It is a pleasure to submit a fotograf of my station, which is installed at my home in Rotterdam, Holland.

Altho no transmitting is allowed here, I may say that my receiving station has given me entire satisfaction in every respect.

I have two aerials, one 240' long and 50' to 160' high, the downlead is at the lower end, the other is much smaller and consists of four wires, 2' apart, 80' long and 45' high. This second aerial is used for short-wave reception, or as a counterpoise.

My set consists of the following:

Short-wave regenerative set, of my own design, long-wave honeycomb coil set, a two-stage amplifier, Murdock fones and loudspeaker.

Honeycomb coils, variable condensers, amplifier and 4,000 ohm loudspeaker are homemade.

Signals from high-powered European stations, such as Nauen, POZ, Paris FL,

Eilweise OUI, are to be heard in the street, my station being on the second floor. Music from PCGG, the Dutch Wireless Industry The Hague, is to be heard all over the house.

I have copied several American stations, for instance NSS, NFF, NDD, NZR, NPG, WSO and WGG, all in daylight, and PRX, Malabar Dutch East Indies, NPO, Cavite, and PKT, Tjililin, also Dutch East Indies, have been heard occasionally.

With amplifier signals from NSS and NFF can be copied 3' to 4' from the loudspeaker.

I hope that in the near future sending will be allowed here, and that the Dutch amateurs will be able to do some fine long distance work, just as the American "fellow bugs" are doing.

I think it would be very interesting to try again to send over the Atlantic with 1-k.w. on 200 meters. If American amateurs send from the Atlantic to the Pacific with a spark set, it seems feasible to reach Europe with a 1-k.w. C. W. set.

J. L. LEISTRA,
4 Walenburgstreet,
Rotterdam, Holland.



Here Boys, Look at This Dutch Amateur. How Do You Like His Home-made Set? Pretty Neat, Isn't It?

John E. Armstrong's Station

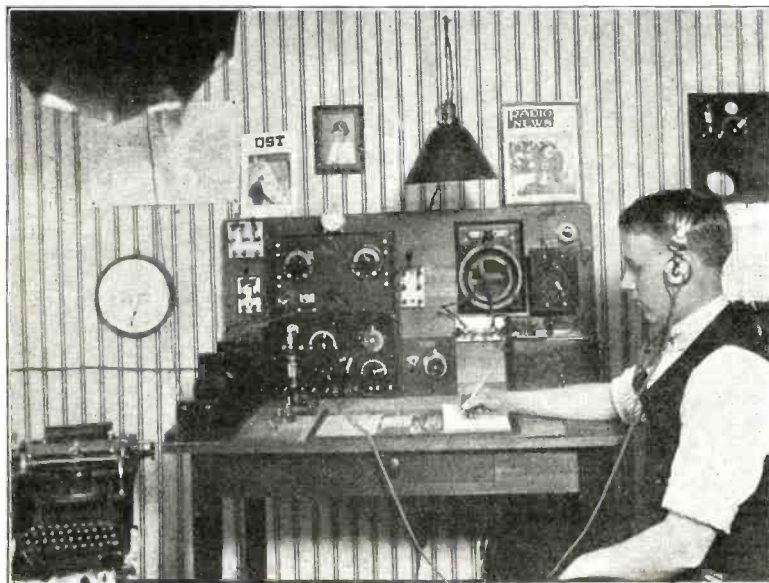

John has a nice desk-type station, and he "builds his own" too. Note that detector panel over his head.

I have at last taken a clear picture of my station. I have tried taking pictures in daylight, but they did not turn out well. This one was a time exposure, using a flashlight.

The following is a description of my station. First of all, my aerial is of the inverted L type, consisting of three wires, spaced 2' apart, 97' long and about 60' high. The ground wire is connected to the radiator. My receiving sets consists of a detector cabinet purchased from Wm. E. Duck Co., and another cabinet made by myself, containing a one-step amplifier and two Murdock condensers. I left room for another step of amplification in this cabinet, which I expect to install in a few weeks. I use Brandes Navy type fones, also Murdock 2,000 ohm fones. Since this picture was taken, I have installed jacks and plugs which I find are very convenient. I am now using one of the new Murdock variocouplers for short wave-lengths and an N. A. A. coupler for long wave-lengths. I get very good results with this set.

I hear radiofone music from many ama-
(Continued on page 150)



Junior Radio Course

THE WAVEMETER—PART TWO

IN the last lesson was given the principle of the wavemeter, with a description of a standard apparatus and its use.

We shall now describe two other types of wavemeter which are also extensively used in Radio stations. The diagram, Fig. 1, shows a simple wavemeter in which a small bulb is used as a resonance indicator, when the apparatus is used to measure the wave-length of a transmitting set.

In this diagram L and C constitute the calibrated circuit, with the bulb W directly connected in this circuit; when the wavemeter is placed near a transmitter and the condenser adjusted, the bulb glows with maximum brilliancy, when the calibrated circuit oscillates for the same period as the oscillating circuit of the transmitter.

As in several cases the power radiated by the sending set is very low, or when the coupling between the wavemeter and the sending set is loose, it is difficult to note the

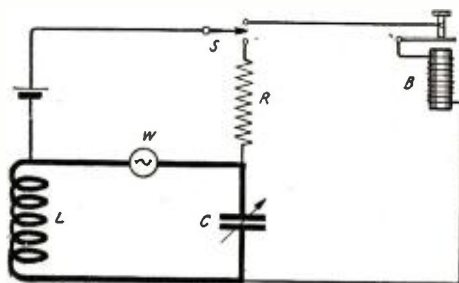

Fig. 1

Diagram of Connections of a Wavemeter Having a Lamp as Resonance Indicator.

maximum brilliancy of the bulb as it does not glow very strongly. This is due to the small energy transferred into the inductance L, and also to the resistance of the bulb. To remedy this, a small current furnished by a single dry cell thru a resistance R, brings the filament to dark red incandescence, only a very small current is therefore necessary to light the filaments to full brilliancy. The resistance R which should be of the inductive type, acts also as a choke coil, keeping out the oscillations from the battery circuit.

By means of a switch S, a buzzer B may be connected to the calibrated circuit allowing the use of the instrument for different purposes, as explained in the last lesson. Instead of a variable condenser connected with an inductance, a variometer is sometimes utilized as calibrated circuit.

THE V. T. WAVEMETER

Fig. 2 shows the circuit of a V. T. wavemeter, which is merely a vacuum tube oscillator, having a calibrated circuit LC. This tube, when oscillating, produces oscillation of various frequencies, according to the value of inductance and capacity used.

The advantage of this type of wavemeter is that the wave radiated is much sharper than the one obtained by a buzzer excited circuit. When used to tune a transmitting set, the wavemeter is placed near a receiver in the vicinity of the transmitter oscillating circuit. The continuous wave emitted by the wavemeter is not audible in the receiver, which should not be of the regenerative type; but only the spark is heard when the key of the sending set is pressed. Keeping the key down, the condenser of the wavemeter is then slowly turned until the tone of the spark becomes mushy. At this point, which is very sharp, the wave-length emitted by the transmitter is shown by the wavemeter scale.

This instrument may also be used in the reception of undamped waves as a separate oscillator, having the advantage of producing only local oscillations in the receiving circuit without radiating any power in the primary circuit. In fact, it is well known that when a receiving circuit is made to oscillate to function as an autodyne, power is radiated by the antenna and may disturb nearby stations receiving undamped waves.

When several stations are tuned on the same wave-length, each of them having a receiver of this type, the disturbance becomes very troublesome in the reception of signals. Using the separate oscillator, such as the V. T. wavemeter, this is completely avoided and furthermore gives the possibility of having steady oscillations which are not affected by the tuning of the receiver itself.

THE WAVEMETER AS AN INTERFERENCE PREVENTER

When strong signals are received by the station, it is easy to use a wavemeter such as described in the last lesson as an inter-

ference preventer. For this purpose, the wavemeter should be connected as in Fig. 2 of the last lesson and after the set is tuned up to the station to be received, the fones or amplifier are connected to the listening circuit L₁ of the wavemeter and the calibrated circuit LK adjusted on the wave-length to be received.

The double coupling between L₃, L and L₁ gives a very sharp tuning and helps greatly to read signals thru a very strong interference, in spite of the resulting decrease of signal intensity.

The same wavemeter connected as above may also be used as a tikker for the reception of undamped waves without a local oscillator or regenerative set. A simple crystal receiver may then be used to receive C. W. The buzzer acting as the tikker should be adjusted so that it produces as constant a note as possible. The condenser of the wavemeter is then set on the wave-

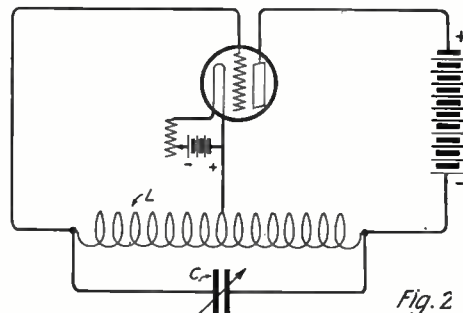

Fig. 2

Circuit of V. T. Wavemeter Which May Also Be Used as a Separate Oscillator.

length to be received and the undamped signals are heard as interrupted C. W.

As may be understood, this system acts as a chopper at the receiving station, and cuts the continuous wave into trains of audible frequency.

QUESTIONS FOR THIS LESSON

1. Explain how the transmitting set is tuned on a certain wave-length by means of a wavemeter having a lamp indicator.
2. Explain the functioning of a V. T. wavemeter.
3. How may a wavemeter be used for the reception of C. W. with a crystal receiver, or non-oscillating V. T.?

DICTIONARY OF TECHNICAL TERMS USED IN RADIO

Shellac—A resin prepared from the juice of certain East Indian trees. The juice, called "stick lac," is removed, forming "seed lac" or "grain lac." It is then melted in boiling water and poured out on to cold flat surfaces, where it dries out into orange-colored brittle flakes, these are the Shellac. It is then easily soluble in Alcohol and makes a very good insulator. S. I. C. about 3.

S. I. C.—See Specific Inductive Capacity.

Silencer—Any arrangement for enclosing the spark gap to prevent the noise causing a disturbance. See Glass Silencer.

Silicon—Si. A. W. 28.2. Non-Met. Element. Greyish metallic looking substance.

Fused silicon is a potential crystal rectifier, and as such is used in contact with copper.

Silicon Bronze—An alloy of copper, tin, and silicon, or copper and silicon alone. Has great tensile strength, and is therefore used for aeriels.

Three-Phase Generator—Has three separate but similar sets of coils in armature windings, dividing space between a pair of poles into three equal parts. Only three collecting slip rings are necessary. Gives three equal alternating E. M. F.'s having phase differences of one-third period.

Three-Wire System—A system of wiring whereby the pressure on the mains is doubled without doubling the pressure imposed on the apparatus. It consists of three wires, Positive, Middle, and Negative. Current is normally divided between the two circuits. Positive-Middle, and Middle-Negative, across either of which load is divided. When load on one circuit exceeds that on the other even pressure is obtained by balancing boosters, placed between Positive-Middle and Middle-Negative circuits. The middle wire is usually earthed, and known as the Neutral Wire.

Junior Constructor

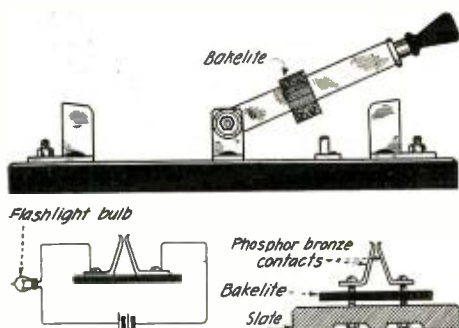

With This Simple Device You Will Not Forget to close Your Lightning Switch.

A LIGHTNING SWITCH REMINDER.

You "hams" do not want your apparatus damaged by lightning. Here is an electric reminder. Cut two pieces of bakelite 2" x 3/4" x 1/8", drill a small hole in each corner, clamp these on the blade of your lightning switch in the center. Then cut another piece of bakelite about the same size, but a quarter of an inch thick and a piece of fosfor bronze ribbon 3" long; cut it in half and bend each as shown in illustration, then drill small holes thru the fosfor bronze clips, the bakelite, and the base of the switch. Now bolt them down, as shown in illustration. Place a flashlight bulb in a conspicuous place and connect it with the clips on the base of the switch. When the aerial is grounded, the bakelite on the blade spreads the clips and the light is out, but if the switch is left open the clips spring together, closing the circuit, and the light turns on.

Contributed by **DICK LONG.**

A CHEAP STRAIN INSULATOR.

Having need for a number of strain insulators, and not wishing to invest too much cash in experimental material, I hit upon the following idea.

Out of a 3/4" board (hard wood preferred) a number of square blocks were cut. These measured 1 1/2" on the side. Two of these were fitted together with their grain crosswise and two small nails driven near opposite corners to hold them while grooves were sawed around the sides for the wires to fit in. They were then dipt in paraffin to waterproof them.

The drawing is self-explanatory and any one having access to a circular saw can quickly make up a large number of these at a comparatively small expense.

Contributed by **HOMER E. TURNER.**

DOUBLE POLE MULTI-THROW SWITCH.

A simple D. P. multi-throw switch may easily be constructed with parts from the junk box.

The construction of the switch blades is shown in Fig. 1. The large blade B is fastened tightly to the knob A, with pins or small screws E and E. The center hole of blade B should be larger than that of

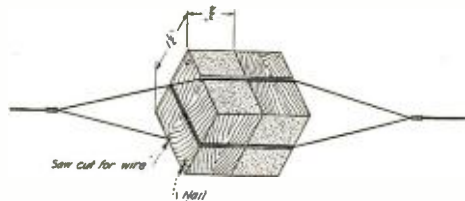

To Replace the Expensive Insulators Where They Are Not Absolutely Needed, This Type is Ideal.

the knob A, so that the blade B will not touch the center screw. A round insulating washer C (bakelite or fibre) with the center hole just large enough to pass the center screw, is placed on the blade. Now the shorter blade D is placed, and the knot F is tightened on the center screw over the shorter blade D, making contact with the center screw. The contact I of the blade B makes contact with the switch points, while the contact 2 of the same blade makes contact on the slider.

Other necessary works are shown in Figs. 2 and 3.

If the work does not appear very neat, a dial may be placed between the knob and the blade B with the indicating mark on it. The dial can be made of an old omnigrاف record.

Contributed by **K. MATSUMOTO.**

A CHEAP QUENCHT GAP

While experimenting with a spark coil transmitter and a fixt spark gap, I tried several devices to cut out the noise produced by the spark. I found that by inserting a

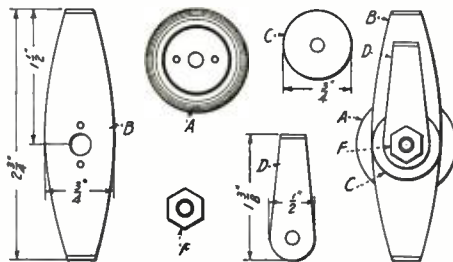

Fig 1

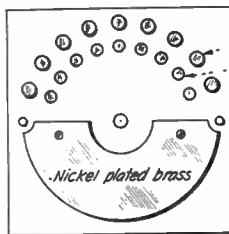

Fig 2

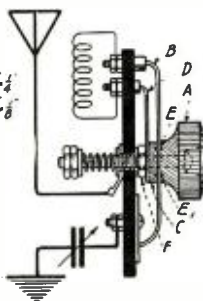

Fig 3

Several Uses May be Found for This Type of Switch Which May Easily be Constructed.

piece of thin asbestos, about 1" square, between the two electrodes of the gap which should be presst tight, the noise was no longer audible and a high-pitched note was produced, which had exactly the same tone as that produced by a quencht gap.

The spark gap used was of the ordinary fixt type with two zinc discs mounted on each electrode. A few small holes should be drilled with a pin into the asbestos.

Contributed by **GEORGE LINN.**

IMPROVEMENT TO THE FORD COIL.

No doubt many amateurs who use Ford spark coils for transmitting, do not know that it is possible to have a note as good as if a rotary gap were used, with far less trouble and no expense.

The accompanying sketch shows the vibrator of a Ford coil. "A" is a small spring behind the vibrator, upon which one of the platinum contacts is riveted. If a small splinter of wood is wedged behind this, to hold it stiff, a fine note is the result. The



Here is a Cheap and Efficient Quencht Gap for Those Who Still Use a Spark Coil.

note may be changed by forcing the wedge down further, or vice versa. When a good note is obtained the spring may be soldered down permanently, if desired.

After the vibrator is wedged as described above, a shorter spark is given from the secondary of the coil, but the coil will send practically as far, and the good note easily makes up for any slight decrease in the transmitting radius.

Contributed by **W. BIAKES.**

A SIMPLE VERNIER.

Many amateurs, I know, have had trouble in tuning in CW, ICW, etc., and have often wished for a vernier for their dials, but as the price of a good one is prohibitive, they are forced to do without one. How many would like one for 5 cents? It is easy to have one for this price and it may be procured at the nearest stationery store; just ask for a pencil with a round rubber on the end. To use this as a vernier, place the side of the rubber against the side of the dial and turn slowly; this will give as good an adjustment as the most expensive vernier, and solves an old problem.

If desired, a vernier built on this principle and consisting of a rod fitted with a rubber tip could be mounted upon the panel. Such a vernier may be used for variometers, condensers or coupling and will be found particularly efficient to tune in fone music or speech, which is always difficult to get tuned sharply.

Contributed by **CALEB PHIPPS.**

A NEW SECRET WIRELESS CODE.

Eotr; rdd od s htrsy hs ,r/
Can you translate it? If you use the touch system of typewriting you can translate is as fast as you can write it down. Simply move both index fingers from the key letters f and j one place to the left to d and h and write as usual the above letters. To write a message in code by this method place the index fingers on key letters g and k one place to right of the standard f and j.

A variety of combinations may be had by reversing the left and right method used above, by shifting the key letters up and down, or by combining both.

Not only is the system effective in preventing the uninitiated from reading the message, but it gains favor by its ease and speed of changing to code and then changing back again. Indeed the message may be translated as received from the ether if the "op" is accustomed to receive directly on the "mily."

Contributed by **BRYCE BRADY.**

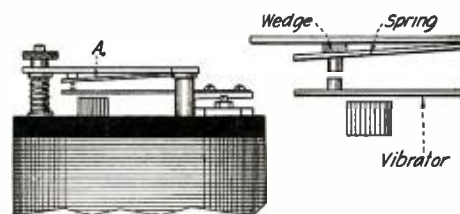

Thanks to This Little Improvement, Those Who Use a Henri Coil May Obtain a Nicer Note.

Correspondence from Readers

RESONANCE WAVE COILS.

Editor RADIO NEWS:

An article on "Resonance Wave Coils" by S. R. Winters, which appeared in the May issue of RADIO NEWS, is apt to create a wrong impression, leading to the belief that Major General George O. Squier, Chief Signal Officer of the Army, was personally responsible for all the development accomplished in the Signal Corps Laboratories in connection with this new important form of radio antenna. The writer of the article has probably misinterpreted the information given him, for errors exist, not only in the text of his article, but in a description of the photographs therewith.

Captain Guy Hill, Signal Corps, and the writer, are anxious to have you give suitable publication to this explanation in order to correct any misapprehension which may result from this paper. The facts in the case are as follows:

General Squier suggested the use of resonance wave coils in connection with his work on "Multiplex Telephony and Telegraphy Over Bare Wires in Water," as a very satisfactory method for securing high potential points at the receiving end of the line without losing the advantage of tuning. As his paper clearly indicates, the device was to be used for receiving only, and then with one end of the resonance wave coil directly connected to line. It also occurred to General Squier that a similar wave coil could be used as an antenna by grounding it at one end and connecting the grid of a three-electrode vacuum tube to a suitable point on the wave coil. Owing to General Squier's many other activities and official duties, he was not able to give this subject any further personal attention, but turned it over to the engineers of the Signal Corps for further study. In his paper on "Multiplex Telephony and Telegraphy Over Bare Wires in Water," General Squier has included a statement covering the operation of the wave coil, used without a ground connection on the coil, as discovered by Captain Hill and the writer, without, however, making any mention of the inventors. This was the first publication of the results obtained in our earlier work using the resonance wave coil for receiving purposes.

Captain Guy Hill and the writer have, during the past year and a half, carried on lengthy investigations, and made a number of important discoveries in connection with the use of the resonance wave coil as an antenna for both transmitting and receiving. Some of the work was described in the article in your May issue of RADIO NEWS.

Patent applications covering a considerable number of applications of the resonance wave coil antenna have been filed both in America and abroad by Captain Hill and the undersigned, and suitable licenses have been given to the United States Government under the patents filed.

It is believed that this type of antenna will be of great value where it is desired to install a radio outfit on a small boat, moving vehicles, or at permanent stations where the available space for the installation of an antenna is very limited.

Articles have already appeared in other radio publications and newspapers regarding our work. In addition, the undersigned, with the assistance of Captain Hill, gave a lecture and demonstration of the receiving and transmitting qualities of this resonance wave coil antenna last fall before the Franklin Institute of the State of Pennsylvania.

Another important development indicated in the photographs you printed, but of which no mention was made in the text, is the work of Dr. Louis Cohen, formerly of the Bureau of Standards and now a Signal Corps engineer, and the writer, in applying

the principles of the resonance wave coils in working out a new method for the elimination of static disturbances and interferences which is yielding very excellent results. The photograph shown in the upper left-hand corner of page 766, RADIO NEWS for May, 1921, forms part of such a device. In this photograph, a resonance wave coil of large size, suitably connected to an ordinary antenna and provided with proper arrangements for eliminating static in connection with the ordinary receiving set, is shown, the coils employed being those designed for extremely long wave-lengths.

As a further correction of the article by Mr. Winters, it is to be noted that the coil shown on the stand in the photograph in the lower right-hand corner of the same page, is a bank-wound resonance wave coil, especially designed for use in connection with the Cohen-Mauborgne static elimination scheme which was described in a lecture by Dr. Cohen before the Franklin Institute on February 3, 1921.

To the Chief Signal Officer of the Army should be given due credit for his arrangements of the wave coil in connection with a wire as used in line radio work, and for his proposal to use a resonance wave coil grounded at one end or connected to a counterpoise for the reception of signals, and also for the interest, encouragement and facilities given to Captain Hill, Dr. Cohen and the undersigned in connection with the development of the resonance wave coil antenna and other inventions described.

This letter is submitted to you with the approval of General Squier.

Very truly yours,

J. O. MAUBORGNE,
Major, Signal Corps.

Washington, D. C.

BRICK-BAT DE LUXE.

Editor RADIO NEWS:

I wish to comment on your peculiar sense of humor regarding the A. R. R. L. I am not surprised, because it is characteristic of the Gernsback family, the biggest fakirs in radio.

The A. R. R. L. is an organization by and for the amateurs, and if it takes a lot of air to run the official organ, the breezes are certainly beneficial to the amateur.

The real "Awful Racket Raisers' League" is the Radio League of America which is so beneficial to the amateur, according to claims of its founders, altho it has accomplished nothing. The A. R. R. L. is becoming bigger and stronger because it does less knocking of brickbats at its rivals and more acting.

Would you dare print this in RADIO NEWS to continue discussion starting by Mr. Andrew Potter?

F. MANN.

324 W. 18th St., New York City.

(Naughty,—naughty, with the accent on the naught—Mr. Mann. Why not at least be original if you wish to see yourself in print? You copied Mr. Potter's letter (July issue) almost verbatim, as far as the sense is concerned, altho we like your gentle tone much better. We also have a sneaking suspicion that you are one of these Awful Racket Raisers yourself, and are just a trifle sore that the shoe pinched you. But—ah—well, once you get beyond the "How's my spark NOW" stage, you'll be a worthy member of that League you defend so stoutly. Until that time, however, we are afraid you will have to belong to the League of Aggrieved Rah Rah Lunatics.—Editor.)

8BIP HUMORLESS.

Editor RADIO NEWS:

This is in answer to Mr. Andrew Potter's (8BIP) letter in July RADIO NEWS.

In my estimation, Mr. Potter has no sense of humor at all and he gets peeved very easily.

Now what Mr. Burgess wrote in the May RADIO NEWS holds no offences for the A. R. R. L. at all. It was just a little enjoyable, funny story and friends of mine and I enjoyed it very much, because with so many serious and instructive articles published in the RADIO NEWS, we like, occasionally, to have some funny story or cartoons or else the magazine would become too dry and monotonous.

Now, Mr. Potter, do not be so cranky; take a little innocent fun once in a while. Be more broad-minded.

ROBERT J. TORAN.

Cambridge, Mass.

OH BOY!

Editor RADIO NEWS:

Have just seen Mr. A. Potter's (8BIP) letter in July's RADIO NEWS, and want to say that:

I agree with him in reference to that so-called funny article by Mr. Burgess in June's RADIO NEWS.

If it was not for the AMERICAN RADIO RELAY LEAGUE, Amateur Radio would not be what it is to-day. The expression "Awful Racket Raisers' League" might be true of the RADIO LEAGUE of AMERICA, but IS NOT TRUE of the A. R. R. L.

I think the least you could do is to apologize to the A. R. R. L. and fellow Amateurs.

I am not daring you to publish this letter, as I know you would not any way, since you are not fair to anyone.

DAVID TALIANOFF, 2PF.

817 E. 16th St., Brooklyn, N. Y.

(Ahem! Respectfully refer our amiable correspondent (who is such a capable amateur that he has not learned as yet how to spell it)—to page 34, July issue of RADIO NEWS. We indeed apologize (which he can't spell either) humbly for the lack of humor that some readers, including our correspondent, seem to have, or rather not have. That RADIO NEWS is not fair to anyone is really news to us, and we are of course only too glad to print this letter to show our readers how narrow-minded certain people can be.—Editor.)

"LET HIM RAVE!"

Editor RADIO NEWS:

If some people don't like stories it isn't necessary for them to read them. I suppose Mr. Potter has never read "The Old Man's" yarns or things like that in "Q. S. T." Let G. Ridleak rave. He's harmless.

Please don't take anything out of RADIO NEWS. It's good enough as it is. I've no kick coming and nobody else should.

EDWARD B. RITCHIE.

Camp Winape, East Charleston, Vt.

THOSE STORIES!

Editor RADIO NEWS:

I have always enjoyed your magazine and found much helpful "dope" in it, but why spoil an issue with such stuff as that story "Martian Madness" in your March issue?

It would be different if the story was supposed to be really humorous, but when it becomes such a farce as that without meaning to, it certainly leaves a "bad taste" in the mouth of your readers. Doubtless many of these are beginners in the radio game, but it certainly wouldn't spoil the story to make it consistent and interesting to every one. If a man must write a story about Radio, let him learn something about it himself first. Please ask Mr. Erald Schivo if he really thinks that by ascending 1,000 ft. in

(Continued on page 140)

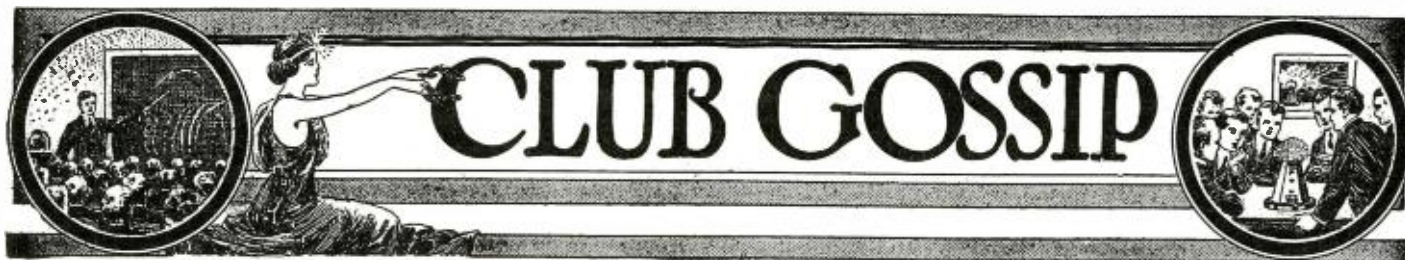
**FORT WORTH RADIO CLUB**

The Fort Worth Radio Club, Fort Worth, Texas, has been organized since August, 1920. The present officers are: Yewell M. Cornelius, president; Melvin Smith, vice-president; and Prof. Oba R. Garrett, secretary-treasurer.

The radio game has been steadily increasing in Fort Worth since the club has been organized, and we now have two good, strong stations, 5LC, owned by Y. M. Cornelius, and 5MN, owned by Horace Biddy. Others are under construction at present. Most all our 30 members have stations. 5LC and 5MN will be glad to QRS or take messages for Fort Worth.

Our club has a little distinction, at least in Texas, as the first lady to be licensed in Texas belongs to our club; she is Mrs. Oba R. Garrett; her station call is 5PJ.

At present the club is holding its meetings each Thursday at 7.30 P.M. in the Telegraf Department of Brantley's Business College. Everyone is welcome to our meetings except the first Thursday in each month, which is devoted to business.

The club would be glad to communicate with other clubs regarding anything of interest to our cause. Address Prof. Oba R. Garrett, Secretary-Treasurer, Radio Club, 611½ Main St., Fort Worth, Texas.

D. A. R. RADIO CLUB OF MENOMINEE, MICH.

This club was organized on March 26, 1921. The officers are: Mr. Raymond Bohne, president; Mr. Robert Landre, acting vice-president; Mr. Otto Jilek, secretary and treasurer; Mr. Paul C. Rawls, instructor; Mr. Robert Landre, code instructor.

It then boasted a membership of eight, but now has 19 members, and one honorary member, Mr. G. E. Peterson, formerly of this city and ex-chief designer and draftsman of the Signal Electric Co. Mr. Rawls is the radio engineer of the same plant and is a prominent man in the radio game.

The radio inspector of the Ninth District is expected up here in a few months and all hope to pass the "exams".

Those who would like to correspond with this club may address all correspondence to Mr. Otto F. Jilek, secretary, 1210 Somerville Ave., Menominee, Mich.

THE HUB CITY RADIO CLUB (SASKATOON, CANADA)

To let you know that the amateurs of Western Canada are up-to-date, I am sending you particulars of the club which was recently formed by a few amateurs in Saskatoon.

The first meeting was held at the home of Thos. Fyfe, on May 4, at which 13 amateurs were present, and the following officers were elected: President Thos. Fyfe, vice-president Cecil Mather, and secretary-treasurer, Wm. Astin. We were fortunate in obtaining as technical instructor, Mr. G. H. Shippen, who served as a wireless operator in the trenches during the war, with the British Army.

It was decided to divide the members in two parts, full members and student members, the fees being the same in both cases, 50 cents per month.

As we have no permanent clubroom at present, the meetings are held at the homes of the different members every Wednesday night. We hope to secure quarters in the local Y. M. C. A. building soon.

The club would be pleased to communicate with other radio organizations or anyone interested. Address the secretary, Wm. Astin, 1312 Avenue C, North, Saskatoon, Sask., Canada.

STAR RADIO CLUB

On May 1 a few radio amateurs met at the home of Joseph Whalen, 113 Philip St., Coal Dale, Pa., and organized the Star Radio Club. The following officers were elected. President, Martin S. Sedlock; vice-president, Rudolf Dubovsky; secretary and treasurer, Joseph L. Whalen. The meetings are held every Tuesday, Thursday and Saturday. All the young men who are interested in radio practice are invited to join, by communicating with Martin Sedlock, Rudolf Dubovsky or Joseph Whalen. There are amateurs here and it was for the purpose of bringing them together and assisting them that the club was formed. The object of the club is to promote interest and knowledge in radio. Correspondence is invited by the secretary, Joseph L. Whalen, 113 Philip St., Coal Dale, Pa.

CANANDAIGUA RADIO CLUB, N. Y.

Canandaigua Academy pupils interested in wireless have formed the Canandaigua Radio Club,

with Charles R. Ladd, science instructor at the school as president, and Rudolph Miller as secretary.

Club members have erected an aerial radio station on the Academy Building and are said to have picked up messages from Arlington, near Washington.

NIRASCO RADIO CLUB

Wireless enthusiasts met at the Y. M. C. A. April 8 and formed the Nirasco Radio Club, with R. D. Nichols as business agent and general manager. Mr. Nichols has had six years' experience as a commercial radio operator and besides being the organizer of the club, is teaching a radio class at the Y. He came here several months ago with his brother, who is connected with Mr. Setter, in the building of the Diamond Theatre.

Officers elected were: George V. Page, president; J. S. Parrigan, vice-president; E. A. Wybrow, secretary; and Trenton Meredith, treasurer. A large number joined the club, among them being J. P. Compton, H. T. Leitchfield, M. Coley, E. A. Hahn, A. H. Temple, J. G. Talbott, L. McCarver and John Gerard, Jr.

Meetings of the club will be held each Friday night.

PHILADELPHIA WIRELESS SCHOOL CONCERTS

The Philadelphia Wireless School gives a concert between 9.45 and 10 o'clock every night to everybody in wireless range who has a receiving set and wishes to listen, and the music is enjoyed regularly by at least 5,000 persons sitting comfortably in their homes, some of them as far away as New Brunswick, N. J. One man in Chestnut Hill made his own receiving set, and the outfit aside from the receivers, cost him about \$7.50.

SOUTH JERSEY RADIO ASSOCIATION

Monthly meetings of the South Jersey Radio Association are held every third Thursday evening of the month in the Mayor's office, Collingswood, N. J.

Interesting talks are given during each meeting.

Visitors are welcome.

STATEN ISLAND RADIO CLUB

The Staten Island Radio Club is growing rapidly in membership because of fone concerts given by us to friends and neighbors. A short-wave regenerative set and a three-step amplifier is being installed. We shall also have our radiofone set in operation in the near future. We received the fight returns of July 2 on Mr. Gropp's three-step amplifier and we installed a loud speaker at a large hotel. It boosted our club very much. We are scouting for every available amateur of Staten Island. Any Staten Island amateur who has not yet joined please communicate with Mr. Gropp. We are going to have a regular traffic schedule on the island. At our last meeting Mr. Gropp gave a short talk on C.W. and fone circuits and Mr. Hitchcock, our vice-president, of short-wave fame, gave a most interesting talk on short-wave regenerative reception on one tube; we also had code practice for one hour on our omnigraf. We are planning for a big season. Meetings are held every Thursday evening at 8 P. M. at Mr. Gropp's Radio Laboratories, 24 Osgood Ave., Stapleton, S. I. This is going to be some club. Watch us grow.

DOWNERS GROVE RADIO CLUB

Altho Downers Grove is a comparatively small town, there is a large number of amateurs in it. Before a radio club was formed there were five to ten unlicensed transmitters in town, but at the present time there is not a single unlicensed set. There are about 18 members now and we hope for several more. At present 9DSG is the only transmitter and he is only on 50 watts, but is now completely remodeling his station by installing a semi-hi-power C.W. set with three operators on watch; within three months there will be four more. Meetings have been discontinued until August, when they will be held semi-monthly. Each meeting is devoted to code drill and instruction in theory by an ex-army operator.

We would be very pleased to receive communications from other clubs and amateurs.

All communications should be addressed to the club's secretary, Wm. J. O'Neill, 123 Summit St.

THE RADIO RESEARCH CLUB OF CANADA

A number of gentlemen in Toronto met in March last and organized a new club to be known as The Radio Research Club of Canada, to be composed of men interested in radio. The general aims of this club are: (a) To bring together for mutual pleasure and benefit, engineers, students and manufacturers of radio apparatus who are interested in high frequency phenomenon, especially in its application to radio communication. (b) That the members may be the better able to co-operate in radio research.

It was moved that meetings be held every third Thursday and Professor Rosebrugh very kindly offered the club the use of a room in the New Electrical Building of the University of Toronto, in which to hold these meetings. The following meetings have already been held:

April 7th—Lecture on "Alternating Currents with Special Reference to High Frequency Phenomenon," by Professor T. R. Rosebrugh; April 28th—Second lecture on the above subject, by Professor Rosebrugh; May 19th—Election of officers for the year. Third lecture of the series by Professor Rosebrugh; June 9th—Fourth lecture, with special reference to "Filters," by Professor Rosebrugh. Exhibition of and discussion on values of various types by Dr. C. A. Culver and Mr. W. C. C. Duncan.

At this meeting it was decided to suspend further meetings until Sept. 22.

The following are the officers of the club, recently elected:

Honorary president, Prof. T. R. Rosebrugh; president, C. A. Culver, Ph.D.; secretary-treasurer, F. K. Dalton; executive committee: W. C. C. Duncan, J. E. Genet, E. J. Bowers.

The club is desirous of including in its membership all of those whose work or interest brings them in touch with the problems of radio communication. Application for membership may be submitted in writing to the Board of Directors, thru the secretary, and must bear the written endorsement of at least three members of the club in good standing. Applicants should state their occupation and the extent of their experience in radio work. The secretary's address is Hydro Electric Laboratories, 8 Strachan Ave., Toronto, Ont., Canada.

IOWA RADIO MEN ORGANIZE STATE RELAY LEAGUE.

The State radio convention, held at Coe College, Cedar Rapids, Iowa, Saturday, May 28, under the auspices of Alpha Chapter, Alpha Delta Alpha Radio Fraternity, resulted in a new State association of radio men called the Iowa Radio Relay League.

The purpose of the convention was to increase co-operation between the radio amateurs of the State, especially in the relay of messages. Under the new plan adopted by the association, relay routes will be mapped out, and definite hours of operation for relaying work will be given to every league member. It is hoped to decrease interference in this manner. This new State relay league will be affiliated with the American Radio Relay League, which is a coast to coast national organization.

The following officers head the new Iowa Radio Relay League: President: Prof. Paul A. Young, Coe College, Cedar Rapids, Iowa; vice-president, Carl Menzer, State University of Iowa, Iowa City, Iowa; secretary, Carleton Sutliff, Marion, Iowa; treasurer, Kermit Bloomer, Burlington, Iowa; relay manager, Peter A. Staver, State University of Iowa, Iowa City, Iowa; publicity manager, Clarence O. Fell, Coe College, Cedar Rapids, Iowa.

Radio men thruout the State are invited to membership in the new association. Particulars may be obtained by writing any of the above named officers.

The following convention program was carried out:

8.30 A.M.—Snappy mixer and a short business session. Appointment of committees by acting chairman, to submit reports at afternoon session.

9 A.M.—Principal factories and points of interest visited by auto.

1 P.M.—Business session proper. Formation of association, reports of committees, adoption of constitution, election of officers.

3.30 P.M.—Baseball game, Coe vs. Cornell; Coe diamond.

6 P.M.—Banquet and toast program; Voorhees quadrangle.

7 P.M.—Lecture, adopted electron theory of electricity and its relation to radio telegraphy and telephony. Prof. LeRoy D. Weld, Coe College.

9 P.M.—Lecture, The Thermionic Valve, Its Use and Calculation; Prof. A. H. Ford, Iowa State University.



THIS Department is conducted for the benefit of our Radio Experimenter. We shall be glad to answer here questions for the benefit of all, but we can only publish such matter of sufficient interest to all.

1. This Department cannot answer more than three questions for each correspondent.
2. Only one side of the sheet should be written upon; all matter should be typewritten or else written in ink. No attention paid to penciled matter.
3. Sketches, diagrams, etc., must be on separate sheets. This Department does not answer questions by mail free of charge.
4. Our Editors will be glad to answer any letter, at the rate of 25c for each question. If, however, questions entail considerable research work, intricate calculations, patent research, etc., a special charge will be made. Before we answer such questions, correspondents will be informed as to the price charge. You will do the Editor a personal favor if you make your letter as brief as possible.

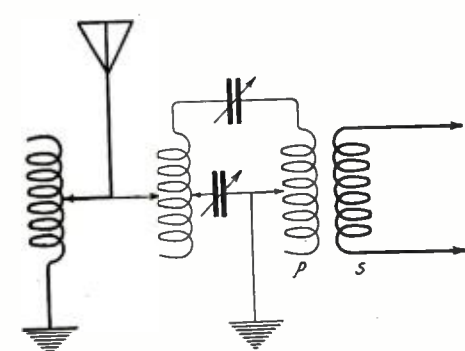

Here is Another Induction and Interference Preventer.

TROUBLESOME INDUCTION.

(285) S. A. McLean, of Halifax, N. S., Canada, writes to us as follows:

Q. 1. I am very much troubled with induction from the ship's dynamo. Using a crystal only, it can be heard quite distinctly, and when using one or two stages of audio frequency amplification, it can be heard several feet from the fones. The sound resembles that of sparking at the brushes, but there is no sparking noticeable.

A. 1. On this page appear two hook-ups which you could try in order to avoid the induction from the ship's dynamo. You could also try shielding the lead in and receiving apparatus; this should be grounded.

Q. 2. What is the size of the former, the amount of wire and the size that should be used for a 200-meter radio frequency transformer?

A. 2. A radio frequency transformer for 200 meters may be made of two honeycomb, or dualateral coils tightly coupled. The primary may be an L25 coil shunted by a small variable condenser, and the secondary and L85 coil. Two pancake coils of the same number of turns could also be used.

L3 AMPLIFIER FOR 100 TO 1100 METER WAVE-LENGTHS.

(236) George W. Curry, of Yoakum, Texas, asks:

Q. 1. Does the L3 amplifier hook-up in the May issue of RADIO NEWS give as much amplification as would five amplifying bulbs and a detector?

A. 1. Yes, but owing to the design of the radio frequency transformers this amplifier is especially efficient for wave-lengths of 100 to 1,100 meters. For longer wave-lengths, resistance coupler amplifiers may be used.

Q. 2. Please publish a hook-up using choke coils as amplifiers, as explained on page 709 of the April, 1921, issue of RADIO NEWS.

A. 2. This hook-up is given on page 686 of that same issue.

Q. 3. Are better results accomplished when you have individual filament control over all amplifying bulbs and detector?

A. 3. Yes, there is an advantage in having individual control for the filament of each tube.

EFFICIENT RADIO-FONE HOOK-UP

(237) Harry Lovell, of Los Angeles, Calif., requests the following:

Q. 1. Please give me a hook-up for a radiofone using

110 volts D.C., modulation transformer, microphone, two amplifier tubes, tuning inductance and necessary capacity.

A. 1. A very efficient hook-up with all the necessary data was given on page 690 of June, 1920, RADIO NEWS.

BEESWAX FOR COIL INSULATION.

(238) Niels W. Bolduan, of Washington, D. C., asks:

Q. 1. In Mr. Adams' hook-up on page 599 of the March, 1921, issue of RADIO NEWS, may the loading inductance be of any size or is it made according to certain specifications?

A. 1. Any type of tuner may be used in this circuit.

Q. 2. May coils be insulated by dipping them in melted beeswax?

A. 2. Yes, beeswax could be used, but we would advise you to use pure paraffin wax instead.

Q. 3. May a key be connected in series with the ground instead of a microphone in the ultra-audion hook-up in order to transmit?

A. 3. If you use this circuit for sending, it

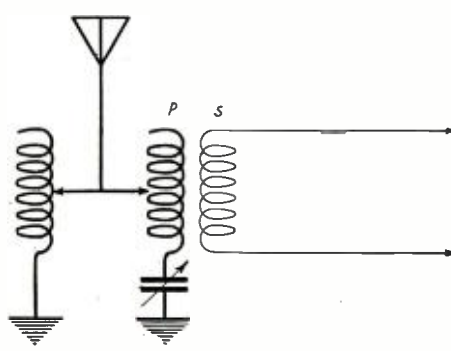

This Circuit May Be Used to Get Rid of the Induction From Nearby Lines.

Q. 1. I understand there is to be a radio convention of the 9th district in August. Please tell me where I can get information regarding same.

A. 1. Information about the A. R. R. L. convention in Chicago may be obtained by communicating with Mr. N. E. Wunderlich, 4533 N. Sawyer Ave., Chicago, Ill.

SHORT FLAT TOP AERIAL.

(240) John A. Sweeney, of New York City, N. Y., wants to know:

Q. 1. Can I build an aerial 28 feet long, 8 feet wide and 60 to 65 feet high, using four wires?

A. 1. Yes, you can erect such an aerial, but we would advise you to take down a four-wire lead in with a spreader at the bottom, in order to keep in the lead in the same distance between the wires as in the flat top.

AMPLIFIER UNIT

(241) Lora Harden, of Columbus, Ind., inquires:

Q. 1. Which aerial is the most practical, a flat top of three wires; a cage of eight wires, or one of a single wire, each 100 feet long with a 50-foot lead in from the middle?

A. 1. For the best results, we would advise the three-wire flat top type of aerial.

Q. 2. Please publish a hook-up for one-step amplifier to which additional steps may be added.

A. 2. A hook-up of this kind appears on this page.

REGENERATIVE SET.

(242) Willard Miller, of Ann Arbor, Mich., writes:

Q. 1. Please give me a diagram showing how to fasten up my receiving set, which consists of two variometers, plate and grid, and one variocoupler, using one radiotron detector bulb.

A. 1. This hook-up was given in the January, 1921, issue of RADIO NEWS, page 443.

TUBES FOR SIGNAL CORP AMPLIFIER

(243) Richard Moro, of Bar Harbor, Me., asks:

Q. 1. May any make and type of tube be used with the signal corps amplifying hook-up, given in the May issue of RADIO NEWS?

A. 1. This amplifier was designed for use with French tubes, but we believe that Moorhead amplifying tubes could be used successfully in this circuit.

Q. 2. Is this circuit equally well adapted to both arc and spark work?

(Continued on page 171)

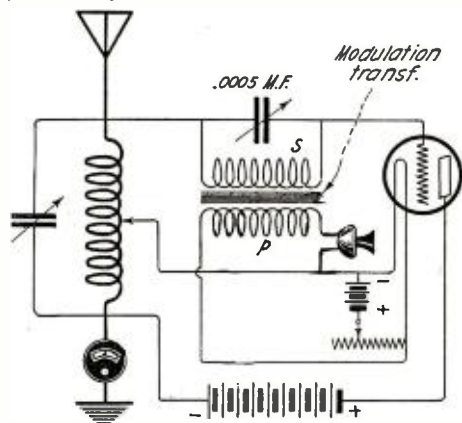

By Connecting a Microphone and Modulation Transformer as Shown, a Simple C.W. Circuit May Be Used for Telephony.

would be better to connect the key in the grid circuit.

CHICAGO CONVENTION.

(239) Donald F. Silver, of Columbus, Ind., writes for the following information:

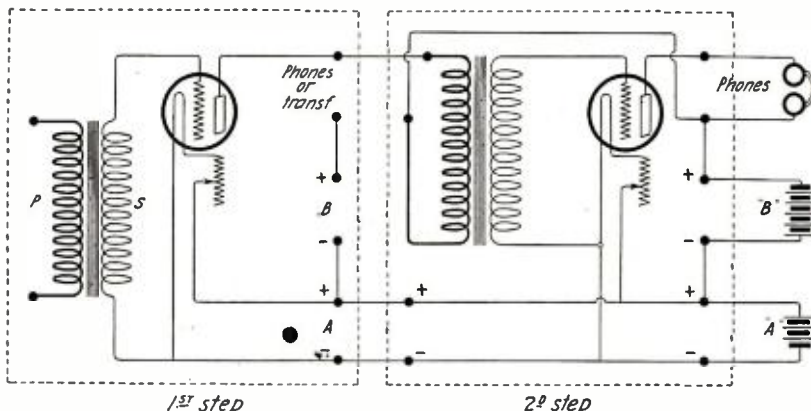

Building the Amplifier Into Units and Using This Hook-up Allows the Addition of Extra Steps Using the Same Batteries.

ANNOUNCING

MURDOCK

RECEIVERS

No. 56

(Patented.—Other Patents Pending)



2000
OHM COMPLETE
DOUBLE SET
\$5.00

3000
OHM COMPLETE
DOUBLE SET
\$6.00

The MURDOCK No. 56 Radio Receiver is a reproduction, with notable improvements, of the MURDOCK No. 55, which have deservedly earned a reputation of UNUSUAL SENSITIVENESS and LONG-LIVED DEPENDABILITY. Years of experience in production have so simplified our manufacturing processes that there is NOTHING QUITE SO GOOD AT SO LOW A COST. Every guarantee that has gone for the last 14 years with MURDOCK Radio Receivers is behind the MURDOCK No. 56.

Receivers encased in MURDOCK moulded insulation; magnet of best quality steel, embedded in case with pole pieces attached permanently and unchangeably; all receivers are by-polar; spools are wound with fine size pure copper wire with enamel coating, this method of winding ensuring a maximum number of effective layers; diaphragm is selected stock of thickness experimentally determined best; special attention is given to a most important feature of receiver efficiency, namely, the proper seating and clamping of the diaphragm; the cap or ear piece is MURDOCK moulded of size and shape best fitted for comfort and exclusion of outside noises; cords supplied with sets are five feet in length with durable mercerized finish. The headband wires are spring phosphor bronze and are covered with black-covered webbing. The design of the MURDOCK No. 56 Headband is unique because of the absence of screws on either Head Band or Receiver Adjusting Bale. The construction plan is the acme of firmness, strength, durability and service, all parts being riveted together.

A WONDERFUL VALUE

2000 ohms	\$5.00
3000 ohms	6.00
1000 ohms Receiver only.....	1.75
1500 ohms Receiver only.....	2.25
Double Head Band.....	1.50

GUARANTEE

Fourteen days' trial allowed in competition with any other receivers. If prior to, or at the expiration of the trial period, the receivers are not found to be completely satisfactory, the purchase price will be refunded upon return of the receivers.

“PERFECT SATISFACTION GUARANTEED OR YOUR MONEY BACK”

BUY THEM FROM YOUR DEALER

SEND FOR BULLETIN No. 21

WM. J. MURDOCK CO. 50 CARTER STREET
CHELSEA, MASS.

509 MISSION STREET, SAN FRANCISCO, CALIF.



Become An Expert in Motor, Generator Repair and Armature Work

Trained men who are competent in Armature winding, Motor and Generator Repair and maintenance are in big demand right now. Take up this work and in a very short time you can step into this growing field and insure yourself a permanent, well paying position with big opportunities for advancement.

Learn in 3 Months

In 3 months you can qualify for positions paying good salaries. Come to this well founded and completely equipped school where you will learn to actually wind every type of D. C. and A. C. armatures. Experts teach and direct you.

Write for Free Book

Mail the coupon today for full particulars of our 3 months' course in Armature work beginning July 5th. Send the coupon and see how easy it is for you to become an expert in only 3 months.

School of Engineering of Milwaukee, Dept. C, 137 Broadway, Milwaukee, Wis. Please send me full information about your three months' course in Armature work. No obligation on my part.

Name
 Address
 City..... State.....
 Age..... Education.....



Build Model Planes

Wading River models are exact scale reproductions of real planes, that's why they fly. You can't go wrong with Wading River plans and parts. Send 10 cents for new 56 page catalogue, showing 25 different models that you can easily build.

WADING RIVER MFG. CO.
 Dept H, 672 Broadway, Brooklyn, N. Y.

PLATINUM IRIDIO-PLATINUM WALLOSTON WIRE

for all radio work at prevailing market prices

WILDBERG BROS.—PLATINUM REFINERS
 Pacific Building, San Francisco

Do You Know Doctor Mu?

STAMMER

If you stammer attend no stammering school till you get my large FREE book entitled "STAMMERING, Its Origin and The Advanced Natural Method of Cure," bound in cloth and stamped in pure gold. Ask for special tuition rate and a FREE copy of "The Natural Speech Magazine." Largest, best equipped and most successful school in the world for the cure of stammering, stuttering, etc. No sing-song or time beat. Write today. The North-Western School, 2366 Grand Ave., Milwaukee, Wis.

Radiofone Goulash

HELLO! HELLO SEND ME TWO POUNDS OF SIRLOIN. WHEN ARE YOU COMING HOME WHO IS THIS PLEASE? HELLO! YES OF COURSE CAN YOU TELL ME SMITH'S ADDRESS? I'LL MEET YOU AT THE CORNER OF APPLE AND WALNUT COURSE ALL RIGHT, DEARIE THE WIRELESS. THE APPLE AT 8.30. WHAT DID YOU SAY YOUR NAME WAS I'LL BE THERE! HOLD AM DETAINED AT THE OFFICE ON IMPORTANT BUSINESS SHE HAD ON JUST LOOK AT THE PRICE. HELLO MABLE. JUST THE CUTEST HAT. OH, NO! THERE SURELY MUST BE SOME MISTAKE! AND I SAID TO HER "LOUISE, IF YOU KNOW WHAT I MEAN. YEP, RUTH GOT THE 50TH TODAY. YOU HAVE TOO MUCH POWDER ON YOUR NOSE. AW, WHERE'D YOU GET THAT STUFF YUH BIG BUM! GET OFF THE LINE! BY BY BABY. HOW ABOUT A LITTLE SUPPER AFTER THE SHOW SOME SERVICE! YOUR WIFE WILL NEVER FIND IT OUT. AW COME ON. HEY, MARY, WHERE DID YOU PUT TH' EGGS? OH, DOCTOR DO HURRY! WELL BE GAME! A LITTLE POKER TONIGHT? WHO'S YOUR FRIEND TA TA, ELLA. IS THAT YOU CLARA? CAN'T YOU COME OUT TO THE HOUSE SEE YOU NATE @ LATER.

Drawn by N. H. COLLINS
 The Comic Weekly "Judge" Runs the Above Under the Caption "A Cross-Section of the Air When the Wireless Telephone Comes Into General Use." Evidently Our Esteemed Contemporary Has Never Put a Pair of Fones to its Ears and Listened to the Q.E.M. Babel That Goes On Nightly. The Above is But a Tame Sample. The Artist Also Forgot a Few Gross of "How Do You Get Me Now?"

The First National A.R.R.L. Convention and Radio Show

In Chicago, on August 30, 31 and September 1, 2 and 3, 1921, the A. R. R. L. will hold a First National Convention and Radio show which everyone is cordially invited to attend.

The first day will be given over entirely to the arrival, registration and location of the many delegates. The program will start promptly at 10 a. m. on August 31, so you should arrange to be in Chicago some time during the previous day, August 30.

Probably the most important feature of the Convention will be the huge banquet on the night of September 3, which all should attend. The charge for this feast will be \$5 per plate and reservations should be made immediately with the Convention Reservation Manager, N. C. Bos, 118 No. La Salle St., Chicago, Illinois.

The Broadway Armory, the most modern and largest exhibit and convention building in Chicago, will be used entirely for this great show.

Now is the time, boys, to get out that bank, open it up and take from it the "Good Time" savings, for here at last is the sure enough "Good Time," and the date is August 30, at Chicago, Illinois.

Radio Experiments With Kites

(Continued from Page 101.)

the construction of the kite. The horizontal or bow stick crosses the upright stick at a point one-seventh of its length, from the top. A string is fastened to each end of the bow stick, in the rear of the kite and it is drawn until the distance from the string to the center of the bow stick is equal to the distance from the top of the kite to the point where the sticks cross—one-seventh the length of the stick itself. The front of the kite is the side facing you when it is in flight and the bowing of the cross stick should be done so that the tips point toward the rear, not the front. Surround the sticks with string, being certain that each side is exactly the same length as the one directly opposite it. If this is not done properly, the kite will not fly straight, if at all. With this cord in place, it is merely necessary to bind the cover to it. If it is to be paper, flour and water will do for paste, but if it is to be cloth it may be either hand or machine sewn. Provision should be made for removing the cover by releasing the string at the tips of the kite and the sticks should be made so that it is easy to take them apart. Nails should not be driven in the sticks, for that weakens them.

The bridle is made by fastening a string at the point where the sticks cross and then bringing it to within two inches of the lower end of the upright stick, leaving it long enough to extend to either tip when the kite is swung and the bridle is taut. The point of the bridle which reaches the tip, as just mentioned, is where the string for flying the kite is attached.

By having sticks of different weights, it is possible to use the same cover for flying the kite in different wind pressures. It will also be found that the placing of a heavy rubber band, or a spring, in the lower portion of the bridle will have the effect of a governor, changing the position of the kite with relation to the wind, so that it will really take quite a gale to put the kite out of plumb. Increasing the amount of bowing will also be found of value for this flying.

The Vocaloud

(Continued from Page 102.)

complete sound chamber is moulded by hand and the device has unbelievable amplifying characteristics, which is the desired goal.

In addition to the wonderful mellow signals obtained from the Vocaloud, the most desirable feature is that no batteries and accessories are required to operate it. It is only necessary to cut it into the circuit, where your fones are ordinarily connected.

The manufacturer claims that on one to three stages of amplification it is more efficient than any other loud speaker on the market, whereas with four or more stages of amplification it is equal to the most expensive loud speaking devices obtainable.

(Fotos by courtesy of J. Firth & Co.)

AN OLD FRIEND IN A NEW DRESS



The New Unit No. 7600 STANDARD VT BATTERY, Price \$3.00

Voltage Variable in Five Steps, from 16½ to 22½ volts.

Reliable and dependable, powerful and enduring, rugged and silent in operation, the STANDARD VT BATTERY stands supreme in the field of quality. Ask your dealer for this quality "B" battery by its full name—he can get them for you if they are not in stock.

The "STANDARD VT BATTERY" is made in the following types, and all types will hereafter be supplied in the black and white box with diamond-shaped label. This for your protection against substitution.

Unit No.	Description	Voltage	Price
No. 7623	Small Size—Non-Variable,	22½	\$1.50
No. 7625	Large Size—Non-Variable,	22½	2.65
No. 7600	Large Size—Semi-Variable,	16½-22½	3.00
No. 7650	Large Size—Fully Variable,	1½-22½	3.50

The Only Plug for Radio For Universal Radio Use



**The Pacent Universal Plug
Price \$2.00**

No connections to solder. Essential for modern radio, for transmission and reception. Approved by the Navy Department. Endorsed by foremost amateurs.



**The Dubilier Universal Condenser
Price \$2.00**

For transmission and reception. Supplied in most used capacities from .01 to .00025 mfd. Especially designed for C.W. Will carry 1 ampere at 1000 volts.

DEALERS AND JOBBERS—You will be interested in our new proposition.
AMATEURS—Send five cents in stamps for bulletins describing "Pacent Radio Essentials"

PACENT ELECTRIC COMPANY, Inc.

LOUIS GERARD PACENT, President

Sole Distributors for Wicony's Complete Line of "Eventual" Apparatus.
Duo-Lateral Coils
Standard VT Batteries
Pacent Plugs
Dubilier Condensers
Special Distributors for Brandes Phones

Sullivan Apparatus
Selbt Instruments

150 NASSAU STREET



NEW YORK CITY

Co-operative Radio Purchasing & C. W. Transmission

C.W. Transmission is the solution of successful Summer Transmission. The Progressive Amateur buys his equipment through a progressive dealer. Our Clients share in our profits. Order either direct from this ad or send stamp for particulars.

TRANSMITTING TUBES

Radiotron UV 202—5 Watts.....\$ 8.00
Radiotron UV 203—30 Watts..... 30.00
Radiotron UV 204—250 Watts.....110.00

TUSKA C. W. INDUCTANCES

No. 181 \$7.00
No. 182 Magnetic Type..... 10.00
No. 183 Tickler Type..... 12.50
No. 181 Unassembled..... 5.00
No. 182 Unassembled..... 7.50
No. 183 Unassembled..... 10.00

ACME CHOKE COILS

1 1/2 Henry 500 M.A. Single Coil.. \$6.00
1 1/2 Henry 500 M.A. Double Coil.. 8.00
1 1/2 Henry 150 M.A. Single Coil.. 4.00
1 1/2 Henry 150 M.A. Double Coil.. 5.00

ACME MODULATION TRANSFORMERS

Type A.3 Mounted on engraved panel \$7.00
Type A.3 Assembled with supports.. 5.00
Type A.3 Core and Coil assembled.. 4.50

ACME C. W. TRANSFORMERS

200 Watt mounted \$20.00
200 Watt unmounted 16.00
50 Watt mounted 18.00
50 Watt unmounted 12.00

ACME PLATE POWER TRANSFORMERS

500 Watt mounted \$25.00
500 Watt unmounted 20.00

ACME FILAMENT HEATING TRANSFORMERS

8 & 10 Volt 75 Watt mounted.. \$12.00
8 & 10 Volt 75 Watt unmounted 8.00
10 & 12 Volt 150 Watt mounted.. 18.00
10 & 12 Volt 150 Watt unmounted 13.00

MUTUAL PURCHASERS ASS'N

2-4 Stone Street New York City

When Romance Meets Up With Science

(Continued from page 118)

Mark? They were on the edge of the Nevada desert and it was quite a stretch of broken country to the coast. As the minutes slipped by, hope commenced to leak from her heart.

"9SY, 9SY, 9SY," she sent forth into the cool, clear night. It was a plaintive call this time, and if the force of her wishes went with it, it must have reached Mars.

She would have formed the "SOS" had she dared, but she knew the rules and she knew the game; she simply gave the Overland's call.

Again she silenced the transmitter and shifted to the sensitive receivers.

Two minutes flitted away and Anita's face grew sad—then in an instant brightened like a pyrotechnic display on a dark night.

A faint, familiar, singing tone filtered over the Rockies and thru the desert ether to the intricacies of the Audion, where it was made audible to ears that loved the sound.

Mark seemed to sense danger. He must have recognized Anita's style of sending, regardless of the strange note. He made the Limited's call a few times and flashed:

"Is that y-o-u? What's the trouble?" with a peculiar separation of the letters in "you" which was enough for the girl to know what he meant.

With an expression of triumph, Anita put this assembly of powerful scientific apparatus to work for her own personal interests—a privilege of the Moderns which would baffle the Ancients.

Slowly but precisely, and in a few words, partly coded in secret characters that even Speedy could not understand, she informed Mark of her predicament.

It was just 7:17 when Mark's clear note sung out:

"Watch for blue light."

Then all was silence.

Anita thot she knew what Mark had meant, but she was not certain. There was nothing to do but wait and see. She drew a breath of relief and spoke softly to Speedy.

"You haven't seen or heard anything, have you, Speedy?" she inquired in a tone that carried a suggestion of a command.

"Not a thing," grinned Speedy. "In fact I'm the most ignorant cuss you ever saw."

"Well, ignorance is bliss—remember that! When 9SY learns what you have done for me—all I can say is that in one way or another you will profit—and you'll be blissful."

Again they bestowed upon each other the smile of comrades in arms, and Anita slipped out.

She sauntered along the corridor and into the observation half of the car, resuming her pouty expression. She selected a book, sat down and opened its pages. But she did not read a line.

Presently the train slackened speed, which brot Papa Brown after Anita.

"You'll have to come into your room now," advised Mr. Brown with a frown which Anita's eyes could discern had been but recently acquired.

"Very well," she agreed, as dispassionately as a clam, and marched off.

Mr. Brown reverently locked the compartment door while the train made a stop. This was foolish, of course, as Anita had no intention now of deserting the train, altho she certainly had had at the start.

She remained in the room with her father and mother, head buried in her book, and did read snatches here and there, until about nine o'clock, when there came a tap on the door and Speedy appeared to inquire after a Mr. Smith, who was plainly fictitious, but

in so inquiring, a meaning signal was flashed to Anita. She could see, also, that the veteran of the key was excited.

After an interval, well calculated, Anita complained to Papa and Mama Brown that it was too warm to be shut up in the room.

"This is such a good book, I think I shall finish it," she told them. "It, at least," she continued with affected sarcasm, "is pleasant company. I'll read in the observation car, where there is someone besides jailers and kidnapers to sit with."

Speedy anticipated the girl's coming. He was standing, with fones on, just inside his door when Anita passed. Quickly he thrust a crumpled paper into her hand, his ears and mind focused on the headphones.

Anita passed on.

When she opened her book, she unfolded the paper, eagerly, anxiously.

"Coming with the Astral. Jimmy piloting. Making 120 and have passed Nevada City. Watch for blue light."

It was not signed. Indeed, a signature would have been superfluous.

Anita's heart thumped against her breast. "Heavens!" she gasped silently. "The ASTRAL! What does he intend to do?"

She was all aflutter.

The Astral was an experimental airplane belonging to Mark Jennings and known to be one of the fastest on the Coast, and large enough to accommodate a half dozen passengers. And Jimmy, she knew, was Mark's brother, a pilot of pilots.

Mark must have been sticking by the Astral's Radio, Anita deduced, and taking bearings on the Limited with his new "pointer."

"But what does he intend to do?" questioned the worried Anita.

"Watch for blue light! Watch for blue light!" kept surging thru her mind.

But where? And when?

She could only wait.

But not for long. Speedy stepped into the observation car and cleverly beckoned to Anita without being noticed by the three or four other passengers lounging about.

Anita rose presently and sauntered into the Radio compartment.

"He must be pretty close!" remarked Speedy with enthusiasm. "Gettin' louder and louder. And asks me to let you sit in. Here; take the fones; I'll stand guard."

Speedy was eager for the game.

Anita understood, and excitedly, nervously now, he placed the fones over her ears, then shot out a few crisp signals that let Mark on board the Astral know she was at the key.

"Stand on platform and watch for blue light. Dress warm. I'm going to take you. Hurry!"

Anita, every faculty highly alert, again broke the night silence with a short string of secret signals. Then, laying down the fones, she shook Speedy's hand and went quickly out into the corridor.

The Overland was now racing across the desert at a high rate of speed, as trains go.

Anita went into the Brown compartment. Mr. and Mrs. Brown were discussing matters foreign to the object of their journey.

"Think I'll step outside and get a breath of air. Then I'm going to bed. You can sit by and guard me all night if you like. I'm going to sleep."

"I guess you're beginning to see where you were wrong," scolded Papa Brown.

"Maybe."

Papa Brown chuckled and gave Mama Brown a wise look, like all wise men do.

Anita slipped on a short polo coat without arousing the suspicions of her guardians, then went out, saying nothing more.

She could not, truth to tell, have spoken a word at that moment had her life depended upon it.

The suspense of not knowing what course of action Mark would follow, after the blue light, left her breathlessly expectant. She knew Mark well enough to know that

(Continued on page 138)

The original tested crystals



Now 25c
GALENA or
SILICON

Be Sure of Results!—Insist Upon Getting
N. A. A. TESTED CRYSTALS

These exquisitely sensitive minerals are the best that money can buy for radio detector and wave meter work. Each crystal is individually tested, wrapped in foil and packed in a convenient lithographed tin container. N. A. A. (Arlington) Tested Minerals are the original tested crystals. To avoid their many imitations, look for the signature of J. S. NEWMAN on each box. Galena or Silicon, now

At good Radio Dealers everywhere, or shipped direct postpaid on receipt of price

25c

THE NEWMAN-STERN CO.
Newman-Stern Bldg. Cleveland, Ohio

1/4 H. P., 110 volts, A.C., 60 cycle, single phase, 1750 R. P. M.

MOTORS

LARGE QUANTITIES NEW WASHING MACHINE MOTORS

These are of standard construction and carry the full factory guarantee. They are of original design. Complete as set. Suitable for operating Coffee Grinders, Cream Separators, Bottle Washers, Air Compressors, Hand Lathes, Etc.

MADE IN U.S.A.

\$22.75 Each

CHAS. H. JOHNSON - Box 16 W. E. Pittsburgh, Pa.

Ask your radio dealer to show you ABC condensers. If he should happen to be without them, send 10 cents and his name and address for the new ABC 16-page, 2-color catalogue, "Professional Radio Equipment at Amateur Prices." Request catalogue CR8.

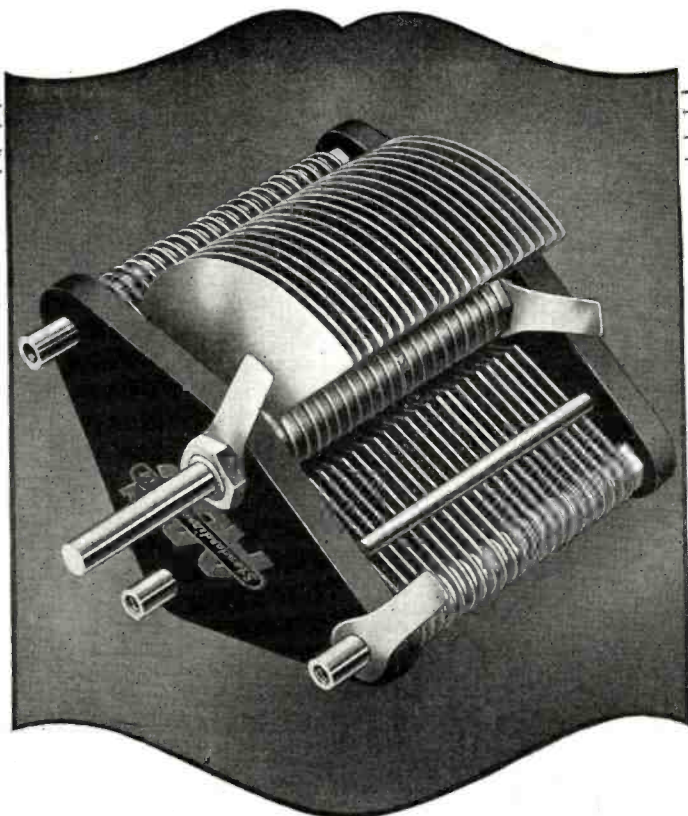

If there is no dealer in your vicinity, we will gladly fill your order by mail. Remember, no matter where you buy any ABC instrument, you are fully protected by the ABC unequalled guarantee, "Your Money's Worth or Your Money Back."

Illustration shows 43 plate condenser, 3/8 actual size.

These 9 Improvements cost you no more!

EXAMINE this photograph carefully. Pick out the *nine* features that distinguish ABC condensers from any other make on the market: 1st, Sturdy plates,—.022 inch thick, that will not jar out of position: 2nd, Individual, not cast spacers, wide to prevent short circuiting: 3rd,

Stop acts on *all* moving plates: 4th, One-piece shaft of brass, *not steel*, turned from solid brass rod: 5th, Shaft turns in solid brass bushing, which extends *thru* head: 6th, *Exclusive* impregnated fibre head, a perfect insulator: 7th, Set screw (underneath) and locking lever

for delicate friction adjustment: 8th, Easily mounted,—all studs *exactly* spaced: 9th, Minimum losses,—1/4" between opposite polarities.

YET ABC condensers are *far lower in price* than any other condenser of similar quality. The automatic production that makes every ABC condenser alike, and every part interchangeable,—at the same time cuts manufacturing cost to a minimum. Materials are the finest obtainable, Workmanship is unexcelled. Automatic production gives you *most value per dollar*.

COMPARISONS are difficult, because there never was a condenser so accurately made before. But compare these prices with the best condenser you ever used:

List No.	Plates	Capacity	Price
650-43	43	.0011 Mfd.	\$5.00
650-21	21	.00055 Mfd.	3.75
650-11	11	.00028 Mfd.	3.00
650-3	3	.0001 Mfd.	2.25

The last type is an excellent vernier condenser or variable grid condenser.

THESE prices are less knob and dial. For ABC brass dial and fibre knob, add 75 cents. For Chelsea composition knob and dial, add one dollar. ABC Dials separately, one dollar.

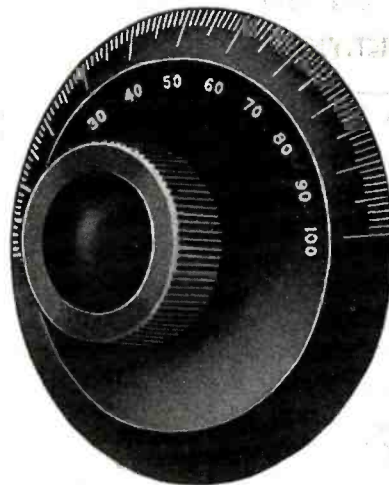
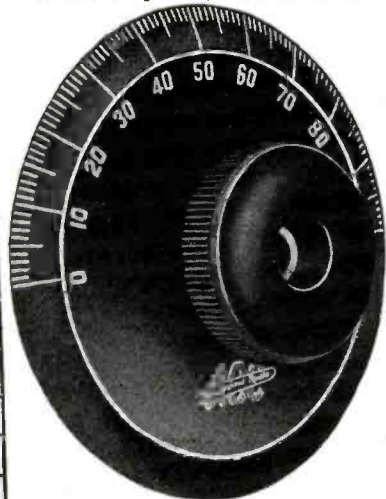

Wireless Equipment Co. Inc.

Newark, New Jersey

ABC VARIABLE CONDENSERS
Standardized Radio

Just mail this coupon and one dime today to the Wireless Equipment Company, Inc., Newark, N. J., for your copy of the new ABC catalog, CR8.

Name

Address

City..... State.....



KELLY & PHILLIPS' service meets with universal approval because it embraces everything that is demanded by the discriminating amateur.

All orders are shipped on the day received unless it is absolutely impossible to do so.

A close connection with all of the leading manufacturers assures you of the high standard of quality which has made them leaders in their line.

Send us your next order and be convinced that KELLY & PHILLIPS' Service is better service.

Anything and everything in radio advertised in this magazine.

Radio Department

KELLY & PHILLIPS
312 Flatbush Ave.
BROOKLYN, NEW YORK

AT LAST THE 100% "B" Battery

The Highest Grade B Battery at the Lowest Price. The Wizard is ready to serve you.



Stop!

paying high prices for your B Batteries. Buy direct from the manufacturer and know that you are getting Fresh Batteries at the right price. We pay all parcel post charges and guarantee our battery to give better satisfaction than any other B Battery.

Cat. No.	Size	Taps	age	Ser.	Price
1623 Plain	2 1/2 x 2 x 3 3/4	2	22 1/2	400	\$1.00
1623 Variable	2 1/2 x 2 x 3 3/4	5	22 1/2	400	1.20
1625 Plain	3 x 4 x 6 3/4	3	22 1/2	1400	1.95
1625 Variable	3 x 4 x 6 3/4	5	22 1/2	1400	2.35
1626 Plain	3 x 8 x 6 3/4	4	45	3000	4.25
1626 Variable	3 x 8 x 6 3/4	6	45	3000	4.50

WIZARD BATTERY CO.
Dept. B, 1323 44th St., BROOKLYN, N. Y.

Do You Know Doctor Mu?

Power Amplification of Audio Frequencies

(Continued from page 96)

music may be heard for several blocks, and a man may speak to several thousand people using the arrangement.

No type of radio amplifier available would give an output of 200 milliamperes under any consideration, so no increase in power of the voice or music could be obtained by using one. In fact it would not be nearly as loud, even using the same transmitter. Therefore, it may be realized that if vacuum tube amplifiers were to be utilized in this problem, it would be necessary to make one along different lines than those now available.

The first power amplifier was made by the Magnavox Company in the early part of 1919, and it was the writer's privilege to participate in the first public demonstration of the apparatus at the opening of the Victory loan on the Treasury steps at Washington, D. C., in April, 1919. The writer, then a Radio officer in the U. S. Air Service, read the President's cable from an airplane in flight, into a radio telephone. This speech was picked up by a receiving set on the ground, amplified by a two-stage radio amplifier, amplified again by a three-stage power amplifier and shot forth to 30,000 persons thru a Magnavox telemegafone (Fig. 2). This first amplifier was naturally a crude affair compared with the present instruments, but had all the essential elements of a true power amplifier. Many changes have since been made, but the main idea remains the same.

In order to derive a power output, power tubes were used. In those days the best power tubes to be obtained were Moorehead transmitting tubes, and in order to get maximum power out of them 600 volts were used on the plates. This voltage was obtained by special dry batteries in blocks of 100 volts each. The total output of this power amplifier was about four watts and a current of about 350 milliamperes could be passed thru the little coil. In the particular experiment described above, of course the full limit of the amplifier was not used, as the received radio signals were much weaker than the current set up by the voice talking into a transmitter, but the entire 30,000 people were able to hear, with about 275 milliamperes thru the little coil. Think what this means, a radio telephone message amplified until the current passing thru the receiver was 275 milliamperes, in 1919.

While this first amplifier was successful, it was not compact and new troubles developed; 600 volt were used on the plate, and therefore 600 volts were passing thru the coupling transformers. It was soon evident that a very particular kind of coupling transformer would have to be developed, with extremely high insulation. Transformers wound to 600 volts would break down at once, and it was found that voltage surges took place that boosted the voltage up to unrealized levels. A design was finally standardized whereby the coupling transformers were wound in pies, primary and secondary alternating, being separated by empire cloth and thin sheets of insulating compound. A total estimated insulation up to 10,000 volts was necessary in the entire make-up of the transformer. For power work, it was found that the closed core design had no advantage over the open type, so the open core type was adopted. The ratio of the transfer coil primary-secondary is 1-1. It has not been found advisable, or rather, there is no advantage in using higher ratios.

Two power tubes are used in each stage. Not for the added value in amplification, which is practically nil, but to insure ab-

MEMORIZE CONTINENTAL CODE ALMOST INSTANTLY BKUMA YRLSBUG

Beginners Have Reported Mastered Code in 30 Minutes. In 45 Minutes. In One hour, One Evening, Etc., Etc. Anybody who can read can learn code quickly and easily.

Dear Sir:—Was busy putting up set and did not really study your chart until one week before examination. With a few nights practice after having mastered Code was able to pass Government Examination with little effort. Your method is sure some easy way to learn that sticker—Continental Code.

Earl Cassell
Call 8BCR
Grafton, West Va.
45 Lincoln St.
Dear Sir:—Think your short cut Continental Code Chart a wonder. Learned half the Code in fifteen minutes. Attention to wireless limited by High School studies. * * * My success due almost entirely to your method. Call 2A01. William A. Oettler, Woodhaven, N. Y., 340 Woodland Ave.
Wireless methods are advertised as best, easiest, quickest and other enticing titles. To avoid disappointment purchase no Code Memorizing Chart, Card or Device until satisfied by statement from actual user that same has proven efficient in use as well as in theory.

INVESTIGATE

If interested, not just curious, send ten cents for Booklet, information and reports with local addresses from 200 successful Short Cut beginners scattered over 44 states. Coupon for one dime good whenever you purchase will be enclosed. No beginner can afford to ignore the quick success of other beginners who have used DODGE ONE DOLLAR RADIO SHORT CUT WHICH TEACHES WITHOUT INSTRUMENTS AND HOLDS THE RECORD FOR SIMPLICITY, EFFICIENCY, ECONOMY AND QUICK RESULTS.

C. K. DODGE

Box 200 MAMARONECK, N. Y.

SECOND INTRODUCTORY OFFER

Bronx Radio Equipment Co.

687 Courtlandt Ave. BRONX, N. Y.

Variometers and Variocouplers same as advertised at \$7.50 and \$8.50.
Our price \$6.75
Real Two Step Amplifiers—Size of panel—11 1/2"x7 1/2". Old English Oak Cabinet. Shipping weight—packed—15 lbs. Price each..... 50.00
Regular stock size amplifiers—5 1/2"x8" panel. Price each..... 40.00
Containing: Federal transformers, plugs and jacks, Paragon rheostats—XX Bakelite.
Special 6 Volt—60 Ampere Storage Battery, price each..... 12.35
B Batteries—Small Type..... .95
B Batteries—Large Type..... 1.75
Navy type electrose insulators, 7 1/2" length, 1/2" column, complete.... .50
Navy type ball electrose insulators, 8" length, 5" diameter, complete. .60
Estimates furnished on receiving, transmitting and phone sets built to your specifications.
FULL LINE OF ALL STANDARD MAKES OF RADIO APPARATUS

RADIO

TELEPHONE & TELEGRAPH APPARATUS OF MERIT

K20A Rotary Enclosed Gap.....\$25.00
K20B Same without motor..... 20.00
K1 Open Rotary Gap..... 18.00
UV200 Radiotron Detectors 5.00
UV201 Radiotron Amplifiers 6.50
UV202 5-Watt Transmitter 8.00

Send 4c for our 55-page Catalog. Full of illustrations, information and prices that will prove attractive

KARLOWA RADIO CO.
611 Best Bldg., Rock Island, Ill.

TELEGRAPHY

(Both Morse and Wireless) and RAILWAY ACCOUNTING taught thoroughly and quickly. Big salaries now paid. Great opportunities for advancement. Oldest and largest school established 46 years. Endorsed by Telegraph, Railway, Radio, and Government officials. Expenses low—opportunities to earn large portion. Catalog free.

OOD'S INSTITUTE D Street, Valparaiso, Ind.

Variometer **MAGECO** Vario-Coupler

150 TO 750 METERS

Type R. V. O. Variometer for Mounting



Complete as illustrated

Price, **\$5.00**

Made in two sizes, grid and plate, wound with No. 18 and No. 20 wire. Forms of hard maple, non-shrinkable. Brass bushings. Accuracy of assembling prevents all wobbling.

Type V. C. O. Vario-Coupler for Table or Panel Mounting

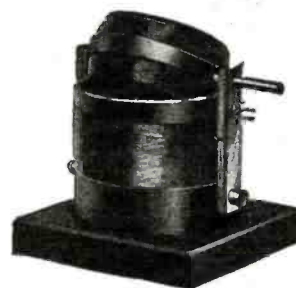

Complete as illustrated

Price, **\$5.00**

Primary of formica tubing wound with 42 turns of 12 taps. Brass bearings support the hard maple rotor, revolving with very close coupling. For panel mounting, remove base and mount.

The Following Responsible Dealers Stock MAGECO Apparatus

American Electro Technical Appliance Co., New York, N. Y.

Continental Radio & Electric Corp., New York, N. Y.

Manhattan Electric Supply Co., New York and Chicago

Kelly & Phillips, Brooklyn, N. Y.

F. D. Pitts & Co., Inc., Boston, Mass.

Atlantic Radio Co., Boston, Mass.

Doubleday-Hill, Pittsburgh, Pa.

Philadelphia School of Wireless Telegraphy, Philadelphia, Pa.

Telephone Maintenance Co., Chicago, Ill.

Detroit Electric Co., Detroit, Mich.

WIRELESS CATALOG JUST OUT 10 CENTS

in stamps or coin brings new loose-leaf catalog—150 pages giving C. W. Hook-ups, Regenerative Hook-ups and all instruments needed for wireless receiving and sending sets—a broad range of prices—places you on mailing list to receive regular bulletins, keeping you posted on latest developments in wireless telegraph and telephone. Illustrations and prices on latest MAGECO apparatus. Write today.

10¢

*Write Your Dealer or the Company,
Toledo, Ohio, U. S. A.*

THE MARSHALL-GERKEN CO.

28 Radio Building

Toledo, Ohio, U. S. A.

A QUALITY PRODUCT FOR THOSE WHO DEMAND THE BEST

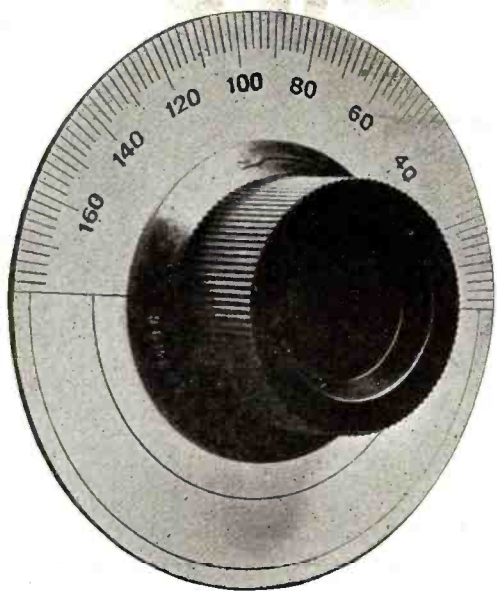

Somerville Dial Indicator \$2.00

These are extremely desirable on the single circuit Tuners which we predict will be the coming Vogue.

The lower half of scale is admirably suited for direct calibration with call letters. Waterproof India Ink is Suggested.

By Rotating the Dial to the right—The Natural Way—The Reading Increases.

Dial is of No. 16 gauge Brass, 4" Dia. Silver Plated and Lacquered. Will not Tarnish.

The Flanged Knob is of Real Bakelite and has a permanent Gloss not to be had with cheap Composition Knobs. Will Not Warp.

The Knob has a 1/4" hole and is Fastened to the shaft by a set screw.

Knob Diameter is 1 3/4". Flange Diameter, 2 1/4". Much experiment shows this to be the right size.

SOMERVILLE KNOB INDICATOR—90c.

This is the same Moulding as used on the dial and, is useful on coupling and Tickler Rotors, etc. Its Non-Melting Feature Makes it invaluable as a Rheostat Knob.

SOMERVILLE SWITCH LEVER—65c

1 1/2" Bakelite Knob to Match the Larger Knobs. 1 3/4" Radius Bronze Blade Locked to the Brass Shaft With Bushing. 2 Locknuts. All metal parts Polished Nickel.

AMATEURS!

Be the first in your town to Rejuvenate your set with Somerville Super-Fine Accessories.

DEALERS!

An excellent investment for profit. Order filled in Retention. Send yours Now.

NEW PRODUCTS: We Have Them First



Murdock No. 56 2000 OHM Headset \$5.00. The same high Quality and Moderate Price as the 55's with the added feature of the New Comfortable Navy Style Headband.

Murdock Improved Crystal Detector, 70c. This New Type has the Universal Adjustment.

Tested and Guaranteed Galena Crystal, 25c.

TYPE J MILLIAMMETERS (D. C.)... \$6.00

0-50, 0-100, 0-300, 0-500, 0-1500 m. a.

TYPE J VOLTMETERS (D. C.) 0-500, \$15.00

TYPE JX VOLTMETERS (A. C.) 0-15, \$8.00

(These are for power tube filaments)

TYPE JT AMMETERS (R. F.-A. C.)... \$12.00

These are our latest thermo-junction radio frequency model, in the Type JX case, 3 3/4" dia. flush. Ranges are 0-1%, 0-3, 0-5, and 0-10 amps. Very accurate!

Each meter guaranteed and sent postpaid

PRICE REDUCTION

SORALA S10 VT SOCKETS—NOW—\$1

postpaid

(Improved design—better appearance)

NEW—NEW

2000 volt test CW condensers. 75c postpaid.

(Capacities available, .001 and .002 mfd.)

A newly developed dielectric and improved design makes this price possible.



CHELSEA 3 B D .0011 Panel Condenser, \$4.75; .0006 size, \$4.25.

CHELSEA 3 3/4" Bakelite Dial—Non-Warping—1/4" or 3/16" Hole, \$1.00.



SPECIAL

\$2.25 Ward Leonard 5000 Ohm Grid Leaks, \$1.88.

Western Electric Headsets, \$11.75.

Send 20c for Catalogue and Treatise on C.W. and Phone Transmitters.

REMEMBER.—We Pay Postage in First Five Zones.

Somerville Radio Laboratory, 102 Heath Street, Winter Hill, 45, Mass.

VARIABLE—ACE "B" BATTERIES—PLAIN

Insist on Getting THE BEST "Ace" "B" Batteries or Write to Us

DEALERS—Sell the "Best" and increase demand.

Write for Catalog No. 15

Cat. No.	Plain	Size	Voltage.	Hrs. Ser.	Lbs.	Taps.	Price.
623	Variable	2 1/2 x 2 x 3 3/8	22 1/2	400	1	5	\$1.50
623	Variable	2 1/2 x 2 x 3 3/8	22 1/2	400	1	5	1.75
625	Plain	3 x 4 x 6 3/8	22 1/2	1400	5	5	2.50
625	Variable	3 x 4 x 6 3/8	22 1/2	1400	5	5	3.00
626	Plain	3 x 8 x 6 3/8	45	3000	10	6	3.00
626	Variable	3 x 8 x 6 3/8	45	3000	10	6	6.00

A few of the dealers handling Ace "B" Batteries

Am. Electro Tech. Appliance Co., New York.
 Continental Radio & Electric Corp., New York.
 Drayfuss Corporation, New York.
 W. B. Duck, Toledo, Ohio.
 Wilcox Lab., Inc., Lansing, Mich.
 Hygrade Electric Novelty Co., New York.
 Manhattan Elec. Supply Co., New York.
 M. Muller, Boston, Mass.
 Vimy Supply Co., Toronto, Canada.
 Whitall Elec. Co., Springfield, Mass.

See page 168 for our new Ace type 45 volt variable "B" Battery

ACE BATTERY MFG. CORP.

44 COURT STREET Phone Main 8379 BROOKLYN, NEW YORK

solute operation in case of the burning out of one tube. Vacuum tubes have that unfortunate faculty of burning out without warning, and it certainly would be very embarrassing to the President of the United States or some other prominent speaker, to have his speech interrupted.

Later, as new power tubes appeared on the market, the output of the amplifiers increased. By the use of DeForest Singer tubes and 600 volts, an output of 400-450 milliamperes may be obtained even with a weak signal or impulse. The amplifiers are designed to utilize the full power of the power tubes with two stages, given a fairly strong input (Fig. 3). In other words, if a public speaker talks directly into the transmitter, two stages are sufficient. However, it has been found that the great majority of public speakers do not care to have the transmitter in their hands, and are also against the restraint put upon their free movements, which is due to the transmitter cord. There is also a technical reason for the transmitter being taken away from the speaker, in that they seldom keep the transmitter at the same distance from their mouths for any length of time. Thus the loudness of reproduction is affected.

Magnavox three-stage amplifiers were developed to meet this situation. No hand transmitter is used, but a sound collector of special design is placed in front, and slightly above the speaker. This sound collector, rather than being a horn, is much the shape of the parabolic mirror of a searchlight, and reflects the sound into a transmitter located at the sound focus. This transmitter is made insensitive to slight sounds, but sufficiently sensitive to pick up the voice. The first stage of amplification then steps up the relatively weak impulse as collected, and passes it along to the two other stages, and the final output is of the same strength as the speaker had been holding the transmitter close up to his mouth (Figs. 4 and 5).

Let us say that with the apparatus as above described, a three-stage power amplifier with Singertubes, sound-collector, and 600 volts on the plates, a current of 400 milliamperes may be passed thru one telemegafone. This telemegafone then will give off a certain volume of sound, sufficient to serve its particular purpose. Let us suppose also that four telemegafones are to be used. Then they must be put in parallel across the power amplifier output. This means that each telemegafone will then have 100 milliamperes of voice current flowing thru it. At once it appears that the total volume then from one horn would be only one-fourth that which would be given off by 400 milliamperes. This, however, is not exactly correct, as the sound thru each of the four horns is really greater than one-fourth of the sound with 400 milliamperes thru the single horn.

It is a fact, however, that telemegafones cannot be put in parallel indefinitely. If 10 of them are put in the above circuit, then the individual input will only be 40 milliamperes and the volume of sound in each will be cut down a great deal.

Two problems were now before the engineers. First, to obtain the maximum possible sound from one telemegafone, and second, to devise an amplifier that would handle any number of telemegafones at the same time and still have sufficient current to give an enormous volume of sound thru each one. Fortunately there came up at this time a demand for loud-speaking equipment which would handle 275 loud-speakers at the same time, each one of which would speak as loud as one had been able to do heretofore with a two-stage power amplifier. A new amplifier, therefore, was necessary, and one which could supply power to 275 at once would also be able to give great power to one if so desired.

It was obvious at once that some new arrangement would have to be made. Up to

KENOTRON RECTIFICATION FOR C.W. TUBE TRANSMISSION



KENOTRON
U.V. 216
20-Watt Output
PRICE \$7.50

THE least expensive and the most satisfactory method of obtaining a direct-current source for plate-excitation is the use of A. C. with Rectifier Valves.

Two types are available for use with Radiotrons. **Kenotron Model U.V. 216** is especially designed to operate with Radiotron U.V. 202, the 5-watt transmitting tube. Filament requires 7.5 volts at 2.35 amperes. The A. C. input is 550 volts. The output of this rectifier tube is 20-watts at 350 volts D. C.

Kenotron Model U.V. 217 is designed to operate with Radiotron U.V. 203, the 50-watt tube. The Filament requires 20 volts at 6.5. The A. C. input is 1250 volts. The output of this rectifier tube is 150-watts at 1000 volts D. C.

Our Standard Porcelain Socket, Model U. R. 542 at \$1.00 will fit Kenotron U.V. 216, while a larger socket of the same type, Model U. R. 541, price \$2.50, is required for Kenotron U.V. 217.

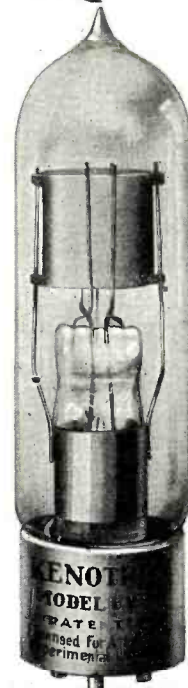

KENOTRON
U.V. 217
150-Watt Output
PRICE \$26.50

The Radio Corporation's tubes are covered by patents dated November 7th, 1905, January 15th, 1907, and February 18th, 1908, as well as by other patents issued and pending. Tubes licensed for amateur and experimental work only. Any other use will constitute an infringement.

A complete line of radio telegraph and telephone sets for amateur purposes will soon be on the market.

For detailed data see your nearest dealer or write direct to

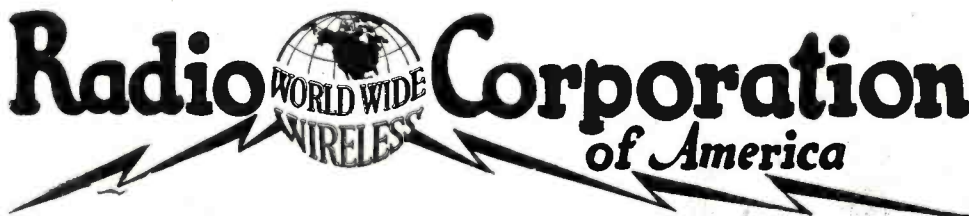

Sales Division, Commercial Department, Suite 1802
233 Broadway, New York City

SHRAMCO REO

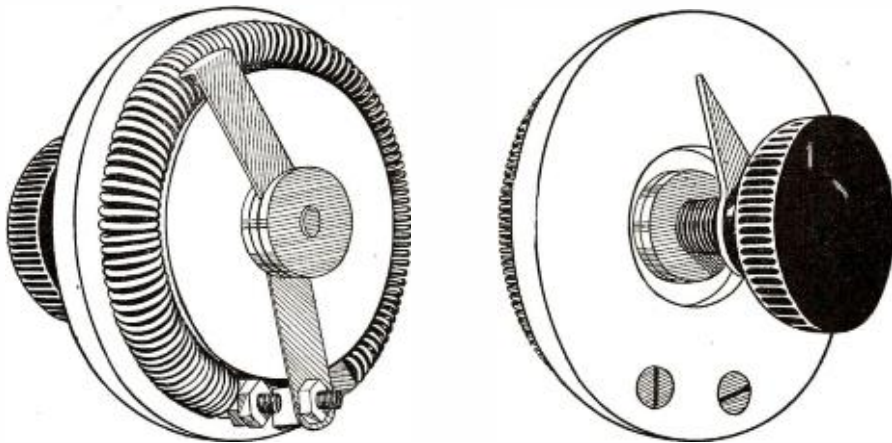

for your power tube—

New type Shramco Reo, No. 90P. 1.5 ohm
Nichrome resistance. Current capacity
6 amperes. Price \$2.00, 1 lb. postage.

A BACK MOUNTED panel rheostat, specially designed for the Radiotron U.V. 202 and other transmitting tubes. Resistance element (1.5 ohm) is "Nichrome" wire, mounted on a solid block of asbestos. Allows unusually accurate and delicate variation of the filament current. All metal parts

brass. Spring phosphor bronze blade. Base 3". Overall height 2½". Handsomely finished and accompanied by an unconditional guarantee of complete satisfaction. Get the most out of your expensive power tube by using a good rheostat. Order a Shramco Reo today! Now ready for immediate shipment.

for your VT detector—

and amplifier, use the original Shramco Reo type 90. Similar to the power tube type, but with a "Nichrome" resistance of 6 ohms. Price \$2.00, plus postage for two lbs. Also available—"Midget" type 90A, same construction, but a 5 ohm resistance and 2½" base.

SHOTTON RADIO MFG. CO., INC.

P. O. Box 3,

Scranton, Pennsylvania

Catalogue "K", listing a complete line of high grade parts at reasonable prices, sent to any reader of Radio News for five cents in stamps.

this time 25-watt power tubes had been available (DeForest Singer) and their full output had been utilized without accomplishing the desired result. The next step was either to turn to the higher power tubes, or to put tubes in parallel in the last stage, and thus increase the output. But one has only to read the specifications of the higher power tubes to see that altho an amplifier could be built using a 250-watt tube in the last stage, the commercial application would be destroyed by the fact that extreme high voltage would be necessary on the plate circuit of that tube. Electrically, practically, and from an expense standpoint, such high power tubes were automatically eliminated. The problem then stood as follows: Using 25-watt tubes and 500 volts with preferably a motor generator for plate supply, what arrangement could be made to get an enormous output, much greater than ever before obtained from an amplifier—40,000 milliamperes of voice current in the output circuit—without distortion, mechanical or electrical complexity, and without undue expense.

Magnavox engineers solved the problem successfully and developed the most powerful amplifier ever made. Its output is between 2,500 and 3,000 milliamperes thru a single telemegafone, this current being entirely voice current. Due to the limiting resistance of the telemegafone no more current will flow thru a single instrument, but with 275 telemegafones, a total current of 40,000 milliamperes is obtained with 160 milliamperes flowing in each one of the entire 275, and by winding the telemegafone fields to 110 volts D. C. excitation an extreme saturation of the field obtained with corresponding increase in sound volume. 275 speaking at once with 160 milliamperes thru each one produce a volume of sound like the rooting section of the Harvard-Yale football game. The total output is then 40 amperes with voice excitation.

This amplifier was called the Magnavox Super-power amplifier and is now being used commercially. The general features of this amplifier may be described, but the exact electrical connections must remain a secret for a time.

A standard two-stage power amplifier is used for the initial step-up. The output of this two-stage amplifier is then led in to the super-power amplifier which consists of five 25-watt tubes so arranged electrically that each one of them may deliver its full power to the output circuit. This arrangement is undoubtedly new and one which is capable of indefinite extension. It would be just as easy for the engineers to build a super-power amplifier with 25 tubes in the final stage as five, and get from the output 200,000 milliamperes or 200 amperes. At present 40 amperes in the output circuit is plenty for the work for which it is developed. This is a great triumph of modern vacuum tube engineering and will solve many of the loud-speaking problems that exist today.

The action and use of this super-amplifier combination is extremely interesting. 2½ amperes thru one telemegafone (20 ohms resistance) will control any type of relay and do all sorts of useful work. For purposes of demonstration and test, a circuit was set up at the factory as follows:

- 1 short-wave regenerative receiver.
- 1 Standard Magnavox telemegafone.
- 1 Radio type two-stage amplifier.
- 1 five-tube super-power amplifier.
- 1 Magnavox two-stage power amplifier.

It must be remembered that the output of the super-amplifier of 2½ amperes is only under extremely strong inputs such as the voice, and is the maximum output.

Signals by radio were then tuned in with varying intensities ranging from 200 to 1,750 milliamperes thru the telemegafone, 200 milliamperes thru the telemegafone being sufficient to carry the signals two or three blocks thru moderate traffic on a busy street. The intensity of the louder signals cannot be described, but it is safe to say that no-

TUSKA MOULDED VARIOMETER

*Mechanically and
Electrically Peerless*

See them at your dealer's

Send 5c for Catalog No. 2

Receiving Sets, Knobs,
Dials, Variometers, Variocouplers, C.W. Inductances, C.W. Transformers.

The C. D. Tuska Co.
HARTFORD CONN.

TYPE 200

PRICE \$7.25

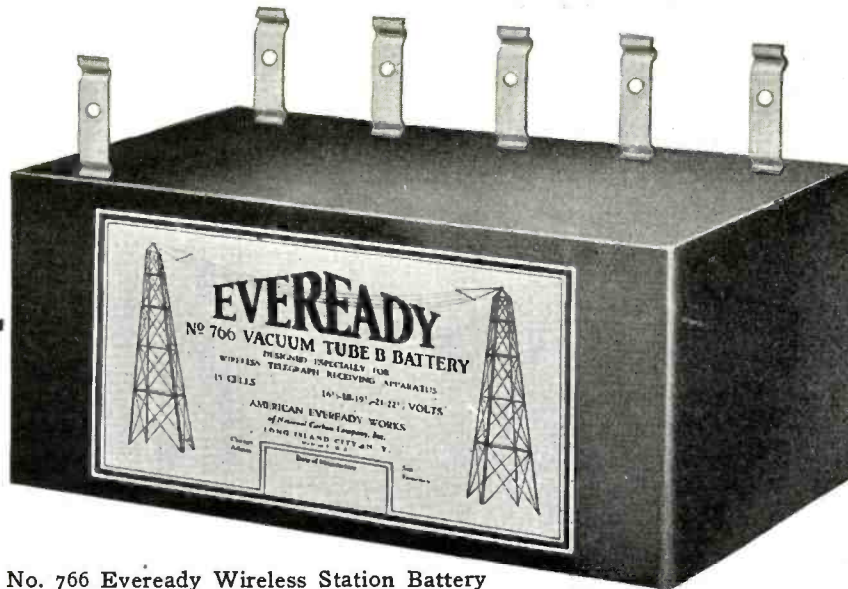

No. 766 Eveready Wireless Station Battery
Standardized for use in U. S. Navy

What makes the Eveready Wireless B Battery absolutely noiseless in operation?

Efficient depolarization; substantial connections; freedom from corrosive punctures and leaks. These are the features that give Eveready that absolute silence—that make Eveready the first choice for every receiving set.

Hitch an Eveready to your set—enjoy the marked increase in the effectiveness of your equipment. Radio equipment dealers everywhere—or write us.



No. 763 Eveready Airplane Wireless Battery.
Standardized for use in U. S. Signal Corps Aviation Section

AMERICAN EVEREADY WORKS
of National Carbon Company, Inc.
226 Thompson Ave., Long Island City, New York
Chicago Atlanta San Francisco

EVEREADY
FLASHLIGHTS AND BATTERIES

Every wireless operator has use for an Eveready Flashlight



**EASTERN
RADIO**

TEL.
BACK BAY
5 9 6 4

INSTITUTE



899 BOYLSTON ST.
BOSTON, MASS.

SUMMER CLASSES!

This year the EASTERN RADIO INSTITUTE will conduct their SUMMER CLASSES as usual. New students may begin to advantage in the DAY or EVENING school on any Monday. Special effort will be made to give every possible assistance to those desiring to accomplish the work during the Summer months and in this respect our DAY school offers unusual advantages.

For the last few months we have been telling you of the "RESULTS" accomplished by the EASTERN RADIO INSTITUTE. This month we want to tell you of its "ADVANTAGES."

"RELIABILITY"

Founded in 1913.
Ninth Successful Year.

"FACULTY"

All Experienced Radio Men.
Each Instructor a Specialist in his Department.

"EQUIPMENT"

Latest Spark, Arc, and Wireless Telephone Sets.
Only School in New England with "Federal Arc Transmitter."

"INSTRUCTION"

The most Systematic, Comprehensive and BEST Radio Course of Any School in the East.
Only School in New England giving "Arc" Instruction upon Actual Apparatus.

"POSITIONS"

Successful graduates of the EASTERN RADIO INSTITUTE are found in responsible radio positions all over the World—Radio Inspectors, Superintendents, Shipping Board Radio Supervisors, Engineers, etc.

"SERVICE"

Remember—Our Organization with over EIGHT years of Continued RESULTS and SUCCESS is behind every student who enrolls. If you want to become a Commercial Radio Operator let us train you.
Just join our SUMMER CLASSES!

Our latest illustrated prospectus is free. If you cannot visit the Institute send for one.

F. D. PITTS, Director

ANNOUNCING
OPENING of the NEW SALESROOM and LABORATORY
OF

RAY-DI-CO

THE
"HOUSE OF BETTER RADIO"

SATURDAY, AUGUST 20th, 1921

where a complete line of standard apparatus, parts and materials will be carried.

To the amateurs we extend a hearty invitation to call and "get acquainted."

MAIL ORDERS GIVEN PROMPT ATTENTION.

RAY-DI-CO

(RAY-DEE-KO)

1547-A N. Wells St. Radio 9AG CHICAGO, ILL.

"We'll look for you at the First National Convention Aug. 30th-Sept. 3rd, Chicago."

where in the world have radio signals been heard with such volume. A wireless telephone conversation was reproduced from the Fairmount Hotel in San Francisco (about 10 miles air line) which was using a five-watt transmitter, putting about 700 milliamperes into the antenna. The speech and music were reproduced in Oakland with well over 1,200 milliamperes flowing thru the telemegafone; in other words, the super-amplifier combination was receiving the wireless telephone speech and music with nearly twice as much current in the receiver as was originally radiated from the sending station 10 miles away. Think of that—the receiving set output greater than the transmitting set output at a distance of 10 miles. If reduced to watts, the actual power was many times greater in the telemegafone.

One of the most interesting experiments was the substitution of a six-volt auto headlight bulb for the loud speaker. As the current in the output circuit is zero when no signals are being received, the lamp is dark; upon reception of signals, the lamp lights up to extreme brilliancy, and such signals may be read directly from the lamp. It is very interesting to see the radio world pass by in the lamp, to read the messages, and to separate one from the other in case of interference. The lamp is very dead-beat, and signals of different intensity may easily be separated. Music and voice, of course, cannot be seen and at the same time be understood, and a very unusual flickering in brightness usually denotes that a wireless fone is being used.

When Romance Meets Up With Science

(Continued from page 130)

he must be desperate and would stop at nothing.

As she passed Speedy's door, he told her cautiously:

"He must be figurin' on beatin' us to Iron-ton! He's right astern! Says he can see our tail lights now. Better look!"

Almost as he spoke, Anita spied a blue light thru the train window, but a short distance behind the train.

Quickly she went to the observation platform. The engine of the Astral was becoming audible above the noise of the train.

By the aid of the moonlight, Anita now perceived what the blue light meant.

It showed from the bottom of a flexible ladder dangling from the Astral, and Anita could now distinguish a form at the bottom of the ladder!

Closer and closer soared the blue light, which, by its relative position to the red tail-light of the train, told Jimmy, the pilot in the Astral, just where to put his ship.

As the seconds fitted by, it became clear to Anita, her eyes becoming accustomed to the night light, that the form standing on the bottom rung of the ladder was Mark Jennings, and he was intent on boarding the train.

But to what purpose to come aboard, when the elder Browns held such vigilance, thot Anita?

As she glanced over her shoulder she was startled to see her father coming thru the car in her direction. Something had ap-

(Continued on page 160)

The Clark Radiofone

(Continued from page 109)

various combinations which we employed would help the average amateur to determine what connections for a ground would bring him the best results. We also found that the more grounds the better, but with four grounds the amperage did not come anywhere near our expectations. Then it was decided that possibly if the receiving

PARAGON R.A. TEN

Protection Against Regrets Absolutely Guaranteed by Originator's Name

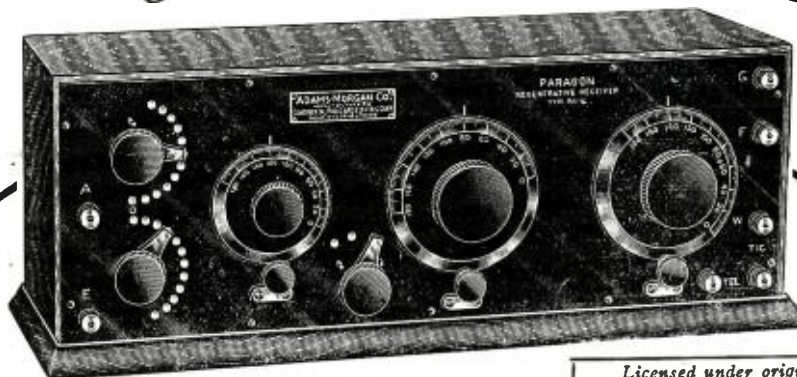

Licensed under original Marconi & Armstrong patents

SEALS BROKEN by popular request!

NO MORE seals on PARAGON R.A. TEN receivers,—take the panel off before you buy,—see for yourself the splendid workmanship behind the handsome cabinet,—and you will better understand the reasons for PARAGON'S unequalled selectivity and amplification.

Ask your radio dealer to show you the inside construction of a Paragon. If he hasn't one in stock he will gladly get it for you.

Endorsed by prominent amateurs everywhere

SCORES of letters on file at our offices from enthusiastic amateurs, testify to PARAGON'S marvellous results. The latest one as we go to press is from J. O. Smith of Valley Stream, L. I. He says, "The PARAGON R.A. TEN receiving set which has been in use at 2ZL station for the past two months has proved to be entirely satisfactory in every way, and has done everything you claimed it would do. It is remarkably efficient and selective on all wavelengths. The R.A. TEN has proved to be especially satisfactory in C.W. work, because of the complete absence of capacity effects."

Other amateurs have "heard stations they never heard before." A Y. M. C. A. radio school tested PARAGON in direct comparison with other leading makes, and reported that "PARAGON fulfilled every advertised superiority." Such endorsement is ample evidence that PARAGON R.A. TEN is well worth its \$85.00 price.

Satisfactory performance absolutely guaranteed

THE CONTINENTAL Radio and Electric Corporation accepts full responsibility for the satisfactory performance of PARAGON R.A. TEN receivers, as long as the internal construction remains unchanged. We cannot, of course, continue to be responsible if the design or wiring has been tampered with. In actual practice, however, the results are so surprisingly pleasing that few have any desire to make any alterations. In any case, Continental will see that you get a square deal and your money's worth.

Special opportunity to radio clubs

IF YOU are an officer or member of a radio club, you will be interested in this special offer. For a short time only, radio clubs in good standing will have the opportunity of securing a genuine PARAGON R.A. TEN regenerative receiver for their club house—absolutely FREE. Have your President or Secretary write on the club's letterhead for particulars at once.

Descriptive folders on PARAGON R.A. TEN and PHONETRON, the improved type of loud speaker, sent free on request. Or send 25 cents for the CRECO catalogue,—listing all the worth while equipment in use today.

CONTINENTAL RADIO and ELECTRIC CORP.

EXCLUSIVE WHOLESALE DISTRIBUTORS FOR PARAGON R.A. TEN AND PHONETRON

J. DiBlasi,
Sec.

Dept. C37 6 Warren Street New York City

J. Stantley,
Treas.



ONE EMPIRE DIAL FREE

With Every Two Dollar Order

During the month of August one regular stock Empire Dial will be included with every order of \$2.00 worth of apparatus.

Don't miss this opportunity to get one of these serviceable dials for nothing;

Look Over These August Specials Carefully—Save Money

VARIOMETERS AND VARIOCOUPERS	
Radisco Variometer	\$7.00
Radisco Variocoupler	6.50

VARIABLE CONDENSERS	
Chelsea .0006 for panel mounting.....	4.25
Chelsea .0011 for panel mounting.....	4.75

"B" BATTERIES ("ACE")	
Small size, 22½ volts	1.25
Small var., 22½ volts.....	1.50
Large size, 22½ volts.....	2.25
Large var., 22½ volts.....	2.75
Large var., 45 volts.....	3.50

PARTS FOR DETECTOR AND AMPLIFIER PANELS	
Remler Rheostat	1.00
Fada Rheostat	1.25
Paragon Rheostat	1.75
Radio Service Socket95
Remler Moulded Socket.....	1.50
Grid Condensers35
Grid Leak Condensers.....	.50
Western Electric Plugs.....	1.00
Rhamstein Plugs75
Rhamstein Jacks75
Cabinet for 6x9x¼" Panel.....	2.00
Acme Amplifying Transformers, mounted	5.00

VACUUM TUBES	
Audiotron, two filaments.....	\$6.00
Radiotron, detector	5.00
Radiotron, amplifier	6.50

MARKO STORAGE BATTERIES	
4 volt 40 to 60 Amp.....	11.00
6 volt 20 to 40 Amp.....	12.00
6 volt 40 to 60 Amp.....	16.00
6 volt 60 to 80 Amp.....	20.00

REGENERATIVE TUNING SETS	
Tuska (up to 800 meters).....	60.00
Turney Short Wave Regenerative Set..	5.50

DIALS, SWITCHES, BINDING POSTS	
Chelsea 3-inch Dial.....	1.00
Adams Morgan 3-inch Dial.....	1.00
Adams Morgan 4-inch Dial.....	1.75
Empire 2½-inch Dial.....	.25
No. 100 Switch, radius 1".....	.60
No. 130 Switch, radius 1½".....	.75
No. 150 Series Parallel Switch.....	.85
Hard Rubber Binding Posts.....	.10
Nickel Plated Switch Points, per doz..	.50

DETECTOR AND AMPLIFIER PANELS	
Detector Control	17.50
Detector and 1-Stage Amplifier.....	45.00
Detector and 2-Stage Amplifier.....	65.00
Two-stage Amplifier	50.00

Empire Radio Equipment Co.

Manufacturers and Distributors of Radio Apparatus

271 West 125th Street

New York City

!!! ALL RECORDS BROKEN !!!

THE MASSACHUSETTS RADIO and TELEGRAPH SCHOOL has broken all records for results during the past six months.

We have produced more First-Grade Commercial Operators during this period than any other school in New England. These men also obtained higher averages on their government examinations and were trained in a shorter period of time than students of other schools.

During the past eight months 16 graduates from the Evening School alone obtained First-Grade Licenses and averaged slightly over 80% out of a possible 90% with only six hours per week instruction. Their average attendance was six months and one week.

We produced more First-Grade Operators in any single month than were produced by any other school, 22 having successfully passed during the month of June. We believe this is a record for any school of the United States and invite comparison.

Formerly the Boston School of Telegraphy established in 1903, the home of Boston's first Wireless Station, when a complete DeForest Transmitter was installed at 18 Boylston Street, we are the oldest Wireless and Telegraph School in New England.

To produce the best results, we must be the best equipped.

Send for our new catalogue containing all the latest information desired by prospective wireless students—It is free. Your name and address will bring it.

G. R. ENTWISTLE, Director of Wireless

We handle a full line of CW and Wireless Telephone Apparatus and Accessories. We would be pleased to advise you on your CW problems.

MASSACHUSETTS RADIO AND TELEGRAPH SCHOOL, INC.

18 Boylston St., Boston, Mass., Corner Washington St.

Tel. Beach 7168. Call (1YS)

antenna of about 400 meters was used as counterpoise, the output would rise still more. We were entirely correct again. So, to get within the law, we used the short aerial of about 200 meters as antenna. On this page is given a chart containing some of the results—the most important.

Perhaps the most surprising result of these tests was the value of the copper plate which is included in the list of the available grounds. In the near future it is expected that the school will have a 2-k.w. transmitting set and this plate, or rather copper screen, was prepared with the idea of using it as the ground for this set, but the results show that it would not be much good. Two connections were made to the steam heating system in order to get a contact on two supplies.

On the evening of April 13, a radiofane concert was conducted. Professor Goddard gave a brief account of the early history of wireless, comparing the radiofane and its possibilities to the innovation of the wired telephone by Bell. After this, selections were read by two members of the Glee Club; that Club's quartette rendered several songs and the concert closed with some records from a victrola. During the progress of the concert replies acknowledging reception were received from amateurs as far as 20 miles away. We wish to thank the following for their answers: IKAS, IBAQ, IHAC, INBE, and IACM. Many others called, but as they had no call letters we have no way of mentioning them except by name.

We consider this a great success in view of the fact that it was only the second time that the set had been operated. Now that experiments with C.W. are in progress we invite anybody within 200 miles to call us—our call is IXZ.

Mechanical Interrupter for D. C. Transmitter

(Continued from page 117)

it in a letter press.

A small condenser should also be shunted across the smaller contacts to prevent sparking and hasten demagnetization thereby increasing the number of vibrations.

For high voltages it would be better to immerse the interrupter in oil.

A wiring diagram is shown in the above illustration.

About six volts are required to operate the magnets.

Correspondence from Readers

(Continued from page 124)

the air he is going to receive a signal from thousands of miles measurably louder.

Who told him that the Japanese use a different code from us? Hope you won't print any more like this. I am not speaking just for myself alone.

PRESCOTT SMITH.

Radio Operator—S. S. Limon—c/o United Fruit Co., Philadelphia Division.

CALL THE RADIO "DOC."

First Op.—"My 'B' battery is dead."

Second Op.—"What from?"

First Op.—"Current consumption."

By HENRY KAUFMANN.

A New Arc Transmitter

(Continued from page 99)

of stability. This is possible with an arc in an atmosphere of hydro-carbon, provided by the alcohol vaporizing rapidly when coming into contact with the red hot cathode. The alcohol found most satisfactory for this work is the denatured alcohol or industrial

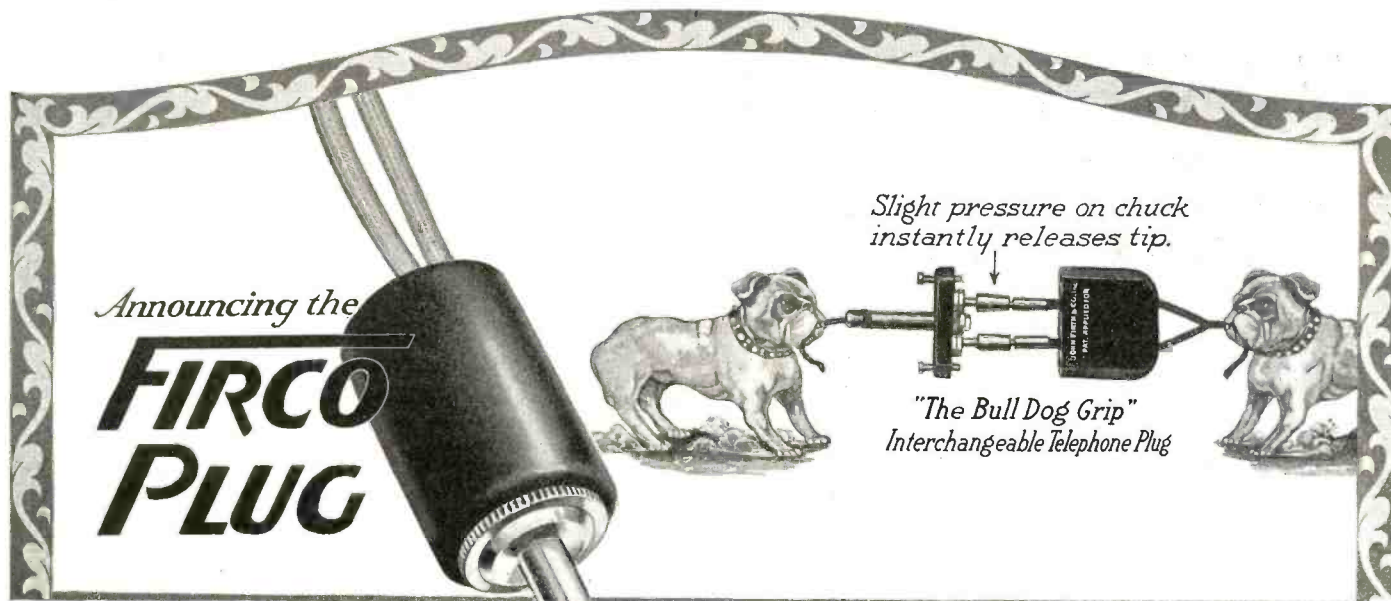

Announcing the
**FIRCO
PLUG**

Slight pressure on chuck
instantly releases tip.

"The Bull Dog Grip"
Interchangeable Telephone Plug

Grips like a Bull Dog

PRICES

- FIRCO PLUG**
(Patent applied for)
- No. 34A, Flat type.....\$2.00
 - No. 34B, Round type... 2.50
- VOCALOUD**
- Station type\$30.00
(In solid mahogany cabinet)
 - Laboratory type\$25.00
(Mounted on adjustable metal base)
- SACO-CLADS**\$5.00
(In individual cartons)

Press the chucks outward, insert any standard telephone cord tip, and then,—“The harder you pull, the tighter it grips.” The same slight pressure instantly releases the tips, so that you can use the plug for another instrument.

You can change from one pair of tips to another in less than 10 seconds. No forcing, no filing, no soldering.

The “Bull-Dog-Grip” makes a perfect electrical connection. Other exclusive Firco improvements reduce the capacity effect and dielectric loss to a minimum. The Firco Radio Plug is provided in two styles, flat, and a new round type, similar to the U. S. Signal Corps standard.

With the round type, all that is necessary to get at the chucks is a few turns of the outer insulating sleeve. No screws to remove, no tools needed.

The flat type is made small and compact for use in small space and corners. A few turns of a screw driver releases the insulating sleeve.

Bring your station up-to-date. Use plugs and jacks thruout. Insist on Firco Plugs in individual cartons from your radio dealer. They fit all standard jacks and cost no more than other plugs without these exclusive improvements.



VOCALOUD

This clear-toned loud speaker is proving the sensation of 1921 radio. No batteries, no adjustments, no extra equipment. Just hook a Vocaloud in and get your signals QSA—all over your house.

SACO-CLADS

The 100% shielded amplifying transformer. No magnetic leakage and no howling. Six steps are entirely practical without howling or squealing. Provides the correct ratio of impedance for modern VTs.



Patent applied for

If there is any Firco product your dealer does not carry, send two cents for illustrated leaflet. Ask your radio dealer to show you the new Firco loose-leaf catalogue. Mailed direct for 25 cents.

John Firth & Company, Inc., 18 Broadway, New York

- 

FIRCO Audion Detectors and Amplifiers
Radio Frequency Amplifiers
High Voltage Units
(any primary voltage)
Baldwin Phones
FIRCO Vocaloud
Saco-Clad Transformer
FIRCO Plug & Accessories
Navy Standard
Leyden Jars
Kolster Decremeter
Eldredge Meters
Brownlie Phones
Seibt Scientific Instruments

FIRCO RADIO EQUIPMENT

“Pioneers—since 1901”

NEW KENNEDY VARIOCOUPLER

Another Mark of Progress

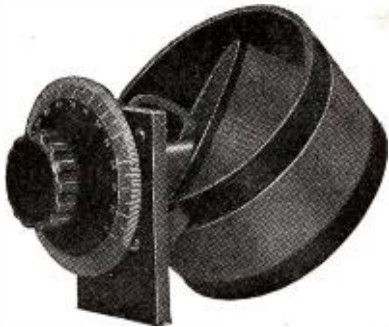

Possesses many outstanding features, among which are:

- 1 Coupling variable progressively through an ARC OF 180 DEGREES.
- 2 Pigtailed connections to rotor. No sliding contacts.
- 3 Secondary mounted concentrically within primary.
- 4 Primary inductance provides for single turn variation.
- 5 Light and compact but strong and rugged. (Weighs only 12 ounces.)
- 6 Highest grade materials. Made of formica, brass and double cotton covered copper wire.
- 7 Minimum solid dielectric in electromagnetic field.
- 8 PRICE \$7.50

With Kennedy bakelite knob and dial as illustrated. 8.75

Ask your dealer

THE COLIN B. KENNEDY COMPANY
INCORPORATED

RIALTO BUILDING

SAN FRANCISCO

kind, commonly known as wood alcohol.

To the right of this device is the handle for controlling the antenna switch. In addition to switching the antenna from the receiving equipment to the transmitter, this switch, using three sets of auxiliary blades, starts the complete arc set ready for transmission in about 10 seconds, provided, of course, the preliminary adjustments have been made. This is discussed in detail further on.

In the center section of the panel, to the left, is the modulating device, for transmitting damp oscillations. It is a motor driven commutator, with every sixth segment short-circuited to a brass ring. The two brushes are connected to a small inductance that is in inductive relation to the main inductance. Then at intervals, this small inductance is short-circuited, causing the main inductance value to decrease and consequently the wavelength to decrease, practically breaking the oscillations up into groups, as the decrease in wave-length is at least 7½ per cent. The speed of this rotating commutator and the number of bars shorted determines the tone frequency for damp transmission. It will be noted from the diagram of this device that by using a switch with an extra contact, the device cannot be used until the motor is up to full speed, preventing misuse of the device.

To the right of the center compartment is the arc chamber, which is cast iron, in two sections, the break being about one-third from the top. Each section has a steel pole piece in the center running vertically, the top section having two field coil sections and the lower section having four field coil sections. Square copper wire is used in these field coil sections to allow the maximum possible current carrying capacity in the small space available. The wire is asbestos-covered, so that the insulation can stand a heavy overload.

The function of these field coils is to provide a strong transverse magnetic field thru the center of the arc flame, this helping the arc to maintain itself and at the same time to handle fairly large powers. These field coils could be separately excited by another source of direct current, but it is very convenient to calculate the necessary flux density, using the normal arc current value as one of the constants and determine the proper number of turns for a given gap accordingly. The difficult part of the design here, is to keep the pole pieces close together and yet far enough apart to keep the arc from flaming over to them, especially when alcohol flows thru and ignites.

Cast in the upper and lower sections are water ducts, making one complete turn around the chamber, for the purpose of cooling. It must be remembered that when using the 5 k.w. input to the arc, about 3½ k.w. of this power is lost in heat. The water is circulated by a centrifugal pump, motor driven, this same motor also being used to rotate the carbon or cathode pole very slowly so that it burns evenly. The cathode is shown in front of the chamber. The carbon can be removed without the use of wrenches and a new one inserted quickly. The anode or copper electrode is on the right-hand side of the chamber. It also has a duct running thru it, and the water circulates thru the anode duct, keeping the copper tip cool; this tip does not burn away to a noticeable extent. On the cathode can be seen the automatic arc-striking device and switch for the starting resistance. The water cooling tank is shown to the right of the panel. It is provided with a sight level glass, outlet valve, etc., and has a hole thru the center, giving that much extra cooling surface. The tank takes approximately two cubic feet of water, weighing about 135 pounds full. This tank is fastened to the ship's bulkhead with castings. A circulation indicator is provided so that the operator can tell if the ducts or hose is clogged at any point. Of necessity,

DETECTOR and TWO STEP AMPLIFIER



Detector and One-Stage Amplifier \$25.00 Is duplicate of above cut only one unit less



The operating characteristics of this instrument are equal to any on the market regardless of price.

\$35.00

The Design and Construction are such that Maximum Amplification is Obtained and No Howling.

Panel 3/16". Bakelite is 7-1/2" x 8-3/4".
Cabinet, Waxed Oak Finish, 5" Deep.

Panel hand rubbed and engraved with white letters
INSTRUMENTS EXACTLY LIKE PHOTOGRAPH

"Notice Clean Cut Wiring." Plug for Fones Furnished with Each Instrument.

ALL INSTRUMENTS ABSOLUTELY GUARANTEED

You can save \$1.50 by buying Radiotron tubes with instruments

361 E. Ohio St.

G. M. PROUDFOOT

CHICAGO, ILL.

CANADIAN AMATEURS'

HEADQUARTERS FOR THE BEST RADIO EQUIPMENT

Write for Price List

SCIENTIFIC EXPERIMENTER, Limited, 33 MCGILL COLLEGE AVENUE
MONTREAL

RADISCO COILS

To buy Radisco Coils is to invest in permanent satisfaction at the lowest prices consistent with an unvarying standard of quality.

Radisco Coils, mounted and unmounted, in ranges to meet every known wave length, are available at the nearest Radisco agency listed below. They range in price from 70 cents to \$2.65. Larger sizes wound with 20/38 Litz at a moderate increase. Three of the larger sizes are also furnished with three taps, to give a wider wave length range.

There is surely some Radisco Coil that will exactly fill your need. And remember, the universal winding that has stood the test of time will make good for you, also.

Note: If you mount your own coils, Radisco coil mountings are made to fit without bending or filing!

This Mark



Your Guarantee

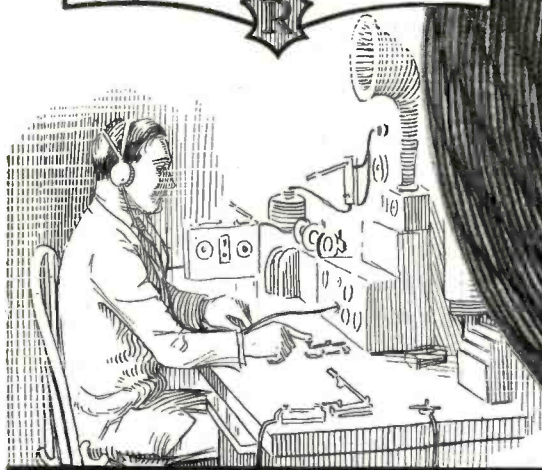
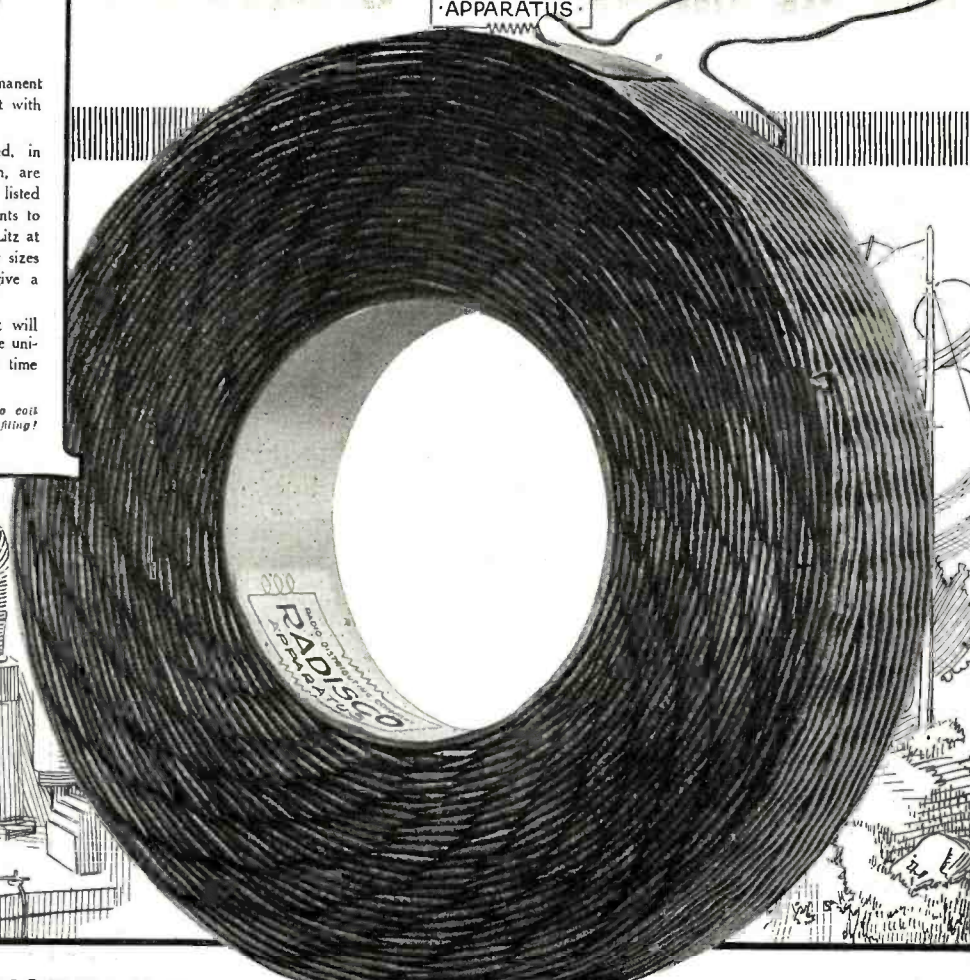

THE RADIO DEALERS listed below are progressive merchants. They are equipped to give you helpful advice and real service in selecting your radio equipment. As an indication of their up-to-date methods, they carry a complete line of Radisco apparatus, including the new vario-coupler, Radisco Coils, Better "B" Batteries, Corwin Dials, etc. Buy from the nearest Radisco agency, and be sure of satisfaction.

ALBANY, N. Y.
Shotton Radio Mfg. Co.
8 Market St.

ASHEVILLE, N. C.
Hi-Grade Wireless Instrument Co.

ATLANTIC CITY, N. J.
Paramount Radio Supply
Arkansas & Pacific Aves.

BOSTON, MASS.
Atlantic Radio Co.
727 Boylston St.

BROOKLYN, N. Y.
Kelly & Phillips
312 Flatbush Ave.

CHICAGO, ILL.
Chicago Radio Labs.
1316 Carmen Ave.
Branch, Peoria, Ill.

EUREKA, ILL.
Klaus Radio Co.

KANSAS CITY, MO.
McCreary Radio Supply
4th and Delaware Sts.

McKEESPORT, PA.
K & L Electric Co.
427 Olive St.

NEWARK, N. J.
A. H. Corwin & Co.
4 West Park St.

NEW ORLEANS, LA.
Rose Radio Supply
604 Gravier St.

OMAHA, NEBRASKA.
O. B. Radio Supply Co.
406 Brown Building.

NEW BRUNSWICK, N. J.
Geo. N. DeLaplaine
306 George St. and
8th and Magnolia Sts.

PHILADELPHIA, PENN.
Philadelphia School of
Wireless Telegraphy
1533 Pine St.

PITTSBURGH, PENN.
Radio Electric Co.
3807 Fifth Ave.

PLAINFIELD, N. J.
Paul R. Collier,
154 E. Front St.

PORTLAND, ME.
Atlantic Radio Co.
15 Temple St.

PROVIDENCE, R. I.
Rhode Island Electrical
Equipment Co.
45 Washington St.

SCRANTON, PENN.
Shotton Radio Mfg. Co.
P. O. Box 3
Branch 8, Kingsbury St.
Jamestown, N. Y.

SEATTLE, WASH.
Northwest Radio Service
609 Fourth Ave.

WASHINGTON, D. C.
Eastern Radio and Elec.
Co., 1405 Florida Ave.,
N. W.

Canadian

MONTREAL, QUEBEC.
J. B. Miller
136 Vendome Ave.,
N. D. G.

TORONTO, ONTARIO.
The Vimy Supply Co.
567 College Street.

To Responsible Dealers

If you are in a town where there is no Radisco Agency, you will benefit by writing for the Radisco plan.

Radio Distributing Co.

Newark, N. J.

RADISCO

"Your Assurance of Satisfactory Performance"

Calling From the "Vasty Deep"

"Glen—I can call SPIRITS from the vasty deep.
 Hat—Why, so can I, or so can any man;
 But will they come when you do call them?"

King Henry IV.

From the wireless outfits on the ships that sail the seas and from the far places of the earth Brandes Receivers call the Spirits of Sound—and they COME!

The signals so weak and encountering such strong interference, that other receivers fail to get them, come "clear as a bell" through the Brandes Matched-Tone Headsets—the wonders of the Wireless world.

"Navy" type headset.....\$14.00
 "Superior" type headset..... 8.00

Sold on 10 days' trial. Money refunded if not satisfactory. Send 5c. for Catalog G. Dealers write for proposition.

C. BRANDES, Inc.
 Room 823, 32 Union Square
 New York City



BRANDES Matched-Tone HEADSETS

BEAT THESE PRICES?

In order to acquaint radio buyers with our unusual service we are deducting 5% from the list price of all CW and Phone Apparatus listed in Catalog CW-2. If you have not a copy of this Catalog send 10c for it TODAY. A few of the bargains are as follows:

"IDEAL" CW EQUIPMENT		"IDEAL" MOTOR-GENERATORS	
Type MGF Filter.....	\$14.25	500 Volt 100 Watt.....	\$70.00
Type ICC Double Choke Coil.....	6.65	500 Volt 200 Watt.....	85.00
Type ICC Single Choke Coil.....	4.75	500 Volt 100 Watt Generator.....	40.00
1 Mfd 1000 Volt Condenser.....	2.00	Field Rheostat.....	15.00
RADIOTRON POWER TUBES		FEDERAL MICROPHONES	
5 Watt.....	7.60	260-W Hand Microphone.....	6.65
50 Watt.....	28.50	262-W Panel with Bracket.....	4.90
Singer 37.5 Watt.....	20.00	263-W Panel Mounting.....	4.90
ACME CW APPARATUS		MOORHEAD TUBES	
50 Watt CW Transformer.....	14.25	Electron Relay.....	5.50
200 Watt CW Transformer.....	19.00	Amplifier-Oscillator.....	6.50
50 Watt Filament Heater.....	11.40	Rectifier Tube.....	8.50
150 Watt Filament Heater.....	15.20	CHELSEA CONDENSERS	
RADIOTRON ACCESSORIES		.0011 Mfd with Dial.....	4.50
Bakelite VT Socket.....	1.40	.0011 Mfd Mounted.....	4.75
Special Socket for 50 Watt.....	4.25	.0006 Mfd with Dial.....	4.00
5,000 Ohm Variable Leak.....	3.00	.0006 Mfd Mounted.....	4.25
Rheostat for 5 Watt.....	1.25	EVEREADY B BATTERIES	
CW INDUCTANCES		22.5 Volt Small.....	2.00
Wimco 25 Turn with Clips.....	9.50	22.5 Volt Large.....	3.00
Wimco 50 Turn with Clips.....	12.50	45 Volt Variable.....	4.50

9XAH IDEAL APPARATUS COMPANY 9XAH
 1901 E. LOUISIANA ST. EVANSVILLE, IND.

FREE With Each U.V. 202 Power Tube FREE

With each Radiotron U.V.202 power tube, for radiophone and C. W. transmission, we will supply free of charge your choice of either the latest Murdock improved contact type V.T. socket for use with the above tube or the Radio Corporation of America's special 5000 ohm, size "M" Grid Leak with midtap at 3,500 ohms, designed by the General Electric Company for use with the U.V. 202. Price \$3.00. Supplied with instructions for operation.

Only new and high grade apparatus carried in stock and all goods guaranteed to arrive in perfect condition. All orders are filled within twelve hours and are shipped postpaid and insured.
 THE KEHLER RADIO LABORATORIES, ABILENE, KANSAS

fresh water has to be used in this cooling system, as salt water would short circuit the anode to ground. Alcohol is mixed with the water in winter to lower the freezing point of the mixture.

One of these 5-k.w. transmitters was installed recently on the S. S. *Minnikada*, the first run with this set installed being to Cuxhaven and Hamburg, Germany, and from there to Italy. Communication was easily established with the German station at Cuxhaven at a distance of 2,500 miles, the German station using a quencht spark transmitter. On the return trip west, communication was established with New York Radio (WSE) at 1,800 miles, but the local New York station was badly handicapped insofar as receiving equipment was concerned.

Another one of these transmitters was installed in the New York Radio station at Babylon, N. Y., and during tests, a tug listening in at Bermuda Harbor, wrote and reported signals readable 10' from the fones, using a Navy receiver and two-step audio frequency amplifier, and the tug's antenna could not have been more than 30' long and 30' high. The arc input at that time was about 4 k.w. and a little more than 1 k.w. input into the antenna, on 2,100 meters.

These transmitters were designed by Messrs. Shoemaker and Farrand of the Liberty Electric Corporation, and built by the same company for the Independent Wireless Telegraph Co., the latter company either selling or renting them to steamship companies.

AT LAST!

Mike—Did you hear about the vaudeville by wireless?

Ike—Yes. It is about time they gave some of those bum jokes the ether.

By W. SCHLUTER.

Radio Helps Fight Forest Fires

(Continued from page 94)

pression forces accordingly. One hour aerial observation was equal to one day's work for two mounted patrolmen."

The efficiency of the service, however, involves the location and prompt correction of every failure attributable to the functioning of wireless equipment. Likewise, a recommendation has been issued to this effect: The minimum requirements in radio equipment demand that at least one ground station be established in each National forest in addition to the stations at bases and sub-bases.

Wireless communication as an agency in combatting forest conflagrations, however, antedates its application as a companion agent of the flying machine. The wireless telephone was for the first time commissioned for this particular service in Montana in the summer of 1919. And, altho in the retrospect, the developments of the preliminary experiments form an integral part of this story. For, had not radio communication proved its worth in the wilderness, its subsequent expansion, as indicated in the preceding paragraphs, would have been discouraged. The gruelling experience of establishing effective radio transmission in mountain fastnesses, the failures and triumphs attending initial efforts should be of interest to amateur operators. The telling of these details will be the burden of the yet unfolded portion of this story. The graphic and frequently thrilling events to be recorded are based on first-hand observations of R. B. Adams, telephone engineer of the Forest Service, who has the distinction of having installed the first wireless outfit as a fire-fighting equipment.

The use of grounds in mountainous areas of the National forests in conjunction with radio telephony proved a failure. The use

AMRAD

The Recognized Symbol of Superior Performance

Prices Reduced : Quality Improved

Every article in the Amrad Line is guaranteed to meet advertised claims and deliver satisfaction. Your nearest reliable dealer will fill your order promptly at the following reduced prices established July 15, 1921.



Knob and Dial, 65c



100 Watt Coil, \$17.50



1/4 K.W. Gap, \$10



Unmounted Variometer, \$6.75

Crystal Receiver \$20, Murdock Headset \$5, Coil Antenna Wire \$1.....	\$25.00
Long Wave Tuner, 2,000-20,000 meters, self-contained.....	30.00
VT Detector Control in Cabinet, as illustrated.....	12.00
VT 1 Stage Amplifier, similar to Detector Unit.....	17.50
VT 2 Stage Amplifier, as illustrated.....	32.50
VT Detector Amplifier, similar to 2 Stage Amplifier.....	27.50
B Battery Box with Potentiometer and Protective Fuse.....	8.50
Variometer, short wave, in Cabinet, highest efficiency.....	11.00
Variometer, short wave, unmounted, as illustrated.....	6.75
Variometer, medium wave, in Cabinet.....	12.00
Variometer, medium wave, unmounted, as illustrated.....	7.75
Coupler, short wave, in Cabinet, two switches.....	13.50
Coupler, short wave, unmounted, like variometer.....	7.50
Coupler, medium wave, in Cabinet, commercial waves.....	14.50
Coupler, medium wave, unmounted.....	8.50
Variable Condenser, .001 mfd. in Cabinet, dustproof.....	9.50
Cabinet—Panel only, 5x5x6 1/4 in. thumb nuts secure panel.....	2.25
Cabinet—Panel, 10x5x6 1/4 in., same size as 2 Stage Amplifier.....	4.00
Cabinet only, 10x10x10 in. inside (3-16 in. panel, \$4.50 extra).....	7.50
Quenched Gap, 1 K.W. Type G-1, for high voltage transformers.....	30.00
Adjustable Resistance for 1 K.W. Gap, Type A-1.....	5.00
Quenched Gap, 1/2 K.W. Type G-2, the popular size.....	17.50
Adjustable Resistance for 1/2 K.W. Gap, Type A-2.....	3.75
Quenched Gap, 1/4 K.W. Type G-3 (for use with spark coils also).....	10.00
Adjustable Resistance for 1/4 K.W. Gap, Type A-3.....	2.50
Induction Coil, 6 volt or 32 volt, highest grade radio coil built.....	17.50
Wavemeter, 175-340 meters; useful as Variometer also.....	13.50
Ampliformer, mounted as illustrated.....	4.50
Ampliformer, unmounted, famous no-lap-joint core.....	3.75
Filament Rheostat, porcelain, 180° throw exclusive feature.....	1.00
Tube Base, takes detector or power tubes. high insulation.....	.75
Detector Stand, duplex type with switch.....	3.00
Detector Stand, single type, very neat and compact.....	2.00
Knob with Dial, 180° or 90°, runs true, lies flat, 1/4 in. shaft.....	.65
Dial only, 180° or 90°, center hole clears 1/4 in. shaft.....	.25
Panel Switch, a semi-midget type, accurately machined.....	.25
Switch Points, fluted shank, 32 per 360 degrees, per pair.....	.05

Improvements include new dark finish cabinets, smoother running controls and more rugged construction. Complete price list or any descriptive bulletins desired sent free from nearest office. Complete catalogue 10c stamps.



Filament Rheostat, \$1



Tube Base, 75c



Ampliformer, \$4.50



VT Detector, \$12



Crystal Receiver, Head Set, Aerial Wire, \$25

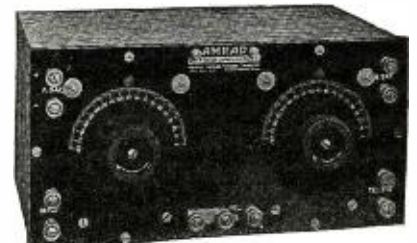

2 Stage Amplifier, \$32.50

AMERICAN RADIO AND RESEARCH CORPORATION

203 College Avenue, Medford Hillside, Mass., Factory, Laboratory and General Offices

15 Park Row, New York City, Sales Offices for 2nd, 3rd, 4th and 8th Districts

608 South Dearborn St., Chicago, Ill., Sales Offices for 5th, 6th, 7th and 9th Districts

ESCO

GENERATORS—MOTOR-GENERATORS—DYNAMOTORS



4 to 32 Volts for Filament
350 to 2000 Volts for Plate

Capacity
20 to 2000 Watts

Liberal Ratings

Write for Bulletin 231
which lists
200 Combinations

Motors and Generators Developed and Built for
Special Purposes

PIONEERS IN THE MANUFACTURE
of
HIGH VOLTAGE DIRECT CURRENT
RADIO GENERATORS

ELECTRIC SPECIALTY CO.

STAMFORD, CONN., U. S. A.

211 SOUTH STREET



of counterpoise yielded a higher radiation. In one instance, where there was an apparently excellent ground, the yield of ampere radiation on the antenna was only .2 compared with .5 of an ampere radiation by the use of counterpoise at the identical location. The combined use of ground and counterpoise connections likewise proved a failure. Installations of wireless telephone equipment in densely-clustered timber, over a range of six miles with the SCR 67A sets, was productive of eminently satisfactory results. Heavy timber seemed powerless to interfere with continuous operation. Still another interesting experiment conducted, involved the placing of two wireless sets on either side of a high ridge, the distance between the two units of equipment being four miles; the distance over the top of the ridge was eight miles, and conversations were carried on without interference and in distinct tones.

What might be described as an inherent weakness of wireless telephony in the vast woodlands is the inability to signal. This obstacle, however, was surmounted by use of a loud speaking receiver, together with a proper amplifier. The objectionable feature of this method of signalling is its power-consuming capacity, a surplus of power being necessary continuously for the lighting of the filament of the vacuum tubes. Of course, the life of the latter is curtailed, humanly speaking, less than the span of three-score-and-ten. Manufacturing companies are now conducting experiments in an effort to improve signalling under adverse conditions, as illustrated by evidence of wireless communication in the National forests. The power problem is a vexatious one in remote areas. Temporarily, the Forest Service solved the problem by using 270 No. 2 Burgess dry cells, connecting these in series and using them on the plate circuits. By this makeshift arrangement, the motor generator was eliminated and the storage battery employed in heating filaments only. The discharge from the storage batteries was decreased from 12 to 3.6 amperes. Likewise by the use of dry batteries the transmission values on the wireless equipment were enhanced 25 per cent. The No. 2 dry batteries were in use for four weeks, or until the radio equipment was dismantled for the summer, at which time they evidenced a slight deterioration. Storage-battery "deaths" at Beaver Ridge were averted by providing a bank of 48 super-six Burgess dry batteries. These were connected in series, parallel, in six different banks of eight, which were to be used as an auxiliary to heat the filaments or drive the motor generator, in the event of accident, to the storage or high-voltage battery. This plan afforded service without interruptions as static was a negligible quantity in the operation of the sets.

Prophetic of the possibilities of radio communication as an instrumentality in arresting the progress of fires on Uncle Sam's reservations, is this commentary of R. B. Adams, telephone engineer of the Forest Service: "After my experience this summer, my conclusions are that the wireless telephone will, in the future, play a very important part in our communication problems. They will not, however, be a substitute for permanent line construction except in certain instances. As a forerunner into outlying points of a permanent telephone line, they can be most successfully used. In many instances this remote territory can be continuously handled by wireless without the construction of a telephone line. To look-out points where the telephone lines are expensive to maintain, wireless (if the distance is great enough) will prove more satisfactory than a telephone line, both in cost and operation. Further experience in the use of wireless sets will demonstrate at a later date which of the Forest Service's 27,000 miles of telephone lines can be substituted with wireless."

"ILLINOIS" THE RELIABLE MADE RIGHT - STAYS RIGHT



STYLE No. 1



STYLE No. 2

Three Styles: No. 1, Panel; No. 2, Open Type as shown; No. 3, Fully Encased. Anti Profiteer. Less than pre-war prices. Fully assembled and tested.

	Style No. 1	No. 2	No. 3
67 Plates,	\$7.00	\$8.00	\$8.50
43 "	3.50	4.50	4.75
23 "	2.75	3.75	4.00
13 "	2.25	3.25	3.50

Money back if not satisfied. Just return condenser within 10 days by insured Parcel Post.

With Style No. 1, we will, if desired, furnish 3 inch Metal Dial with large Knob, instead of Scale and Pointer. Extra Price 75 cents. Or we will, if desired, supply the Condenser with smooth 3-16 inch center staff, without Scale, Knob and Pointer, at 15 cents off the list to those who prefer to supply their own dial.

Vernier with single movable plate applied to 13, 23 or 43 plate condenser, \$3.00 extra.

We allow no discounts except 5 percent on orders of 6 or more.

Sent Prepaid on Receipt of Price

Except: Pacific States, Alaska, Hawaii, Philippines and Canal Zone, add 10c. Canada add 25c.

Foreign Orders other than Canada not solicited.

G.F. JOHNSON, 625 Black Ave., Springfield, Illinois.



VERNIER

REMLER

Apparatus Radiates Quality

No. 100

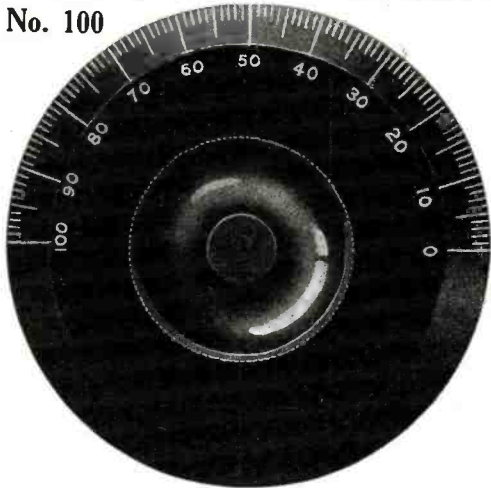

REMLER BAKELITE DIAL

THIS Remler 3" bevel edged dial is molded and ground true from genuine bakelite and will not warp or discolor. It is not brittle like composition. The surface is highly polished. The engraving is filled with white enamel and the 100 division scale reads from right to left for clockwise rotation. The knob is molded bakelite 1 3/8" diameter. The bushing is drilled for 3/8" or 1/4" shaft, and the set screw passes through both knob and bushing. The construction insures an absolutely true running dial.

- No. 101 Remler 3" Bakelite Dial \$.75 only
- No. 100 Remler 3" Bakelite Dial with knob and bushing, specify 3/8" or 1/4" shaft 1.00

No. 810



REMLER Jr. Panel Type RHEOSTAT

REMLER, JR. Rheostat No. 810. Resistance unit of 4 ohms with a carrying capacity of 1 1/2 amperes mounted on a bakelite disc 2" in diameter. It is especially designed for filament control of vacuum tubes operating on 4 or 6 volts. The resistance unit is a non-corrosive alloy and can be readily renewed—an exclusive Remler feature. All metal parts are nickel plated and those showing in front of panel are bright polished nickel. An off position is provided, obviating the necessity of a filament switch.

- No. 810 Remler Jr. Panel Rheostat, 4 ohms resistance..... \$1.00
- No. 810 RU Resistance Unit Renewal20

No. 92

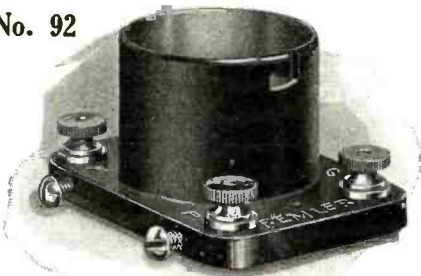

REMLER VT TUBE SOCKET Panel or Table Mounting

THIS receptacle is designed for all standard 4 prong based vacuum tubes, including the new Cunningham Tubes.

The entire socket is molded from black Bakelite, with a highly polished surface. The base of the socket is of sufficient depth to allow clearance between contact fingers and table.

The contact fingers are nickel plated spring brass. Nickel plated binding post terminals are marked. Nickel plated screws are provided for panel mounting and holes drilled for table mounting. When mounted on panel the tube is set vertically, insuring maximum filament life. Base is 2 1/4" x 2 3/4", and the height 1 3/4".

- No. 92 Remler VT Socket, Panel or Table Mounting \$1.50

No. 93



Patent Applied For

REMLER A-BATTERY POTENTIOMETER

THE plate voltage of any detector tube must be carefully adjusted for maximum sensitiveness and signal audibility. Potentiometer control provides close adjustment with ease of operation. This new Remler Unit with metal inserts provides positive definite electrical contact and eliminates the uncertainty of carbon to graphite contact. This Remler Unit is not brittle and is connected across the A-Battery to control the plate potential over a six volt range by half-volt steps. Circuit diagram furnished with each unit.

- No. 93—Remler A-Battery Potentiometer Unit only, with studs for panel mounting75c
- No. 94—Remler Rotary Lever Switch for use with No. 93 Unit..... .45c

DEALERS: There is an exclusive and very profitable proposition for you on Remler Apparatus. Write for full particulars.

REMLER RADIO MFG. CO.,

E. T. CUNNINGHAM, General Manager
163 Sutter Street San Francisco

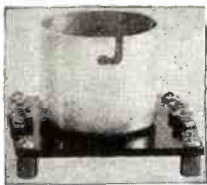

RADIO SERVICE

Type S10—Single Socket **REDUCED TO \$1.00**

The Best Socket Obtainable Regardless of Price

- Type S24—Aluminum Socket only.....50c
- Type S3—Double Socket\$2.50
- Type S4—Triple Socket\$3.50

Here's the Wonderful Little Radio Set

that was described in April's Radio News, page 680, in the New York World and shown in Pathe's Weekly. Just the thing for Boy Scouts, Campers and for use on bicycles, etc. Complete in every respect and guaranteed to give complete satisfaction. Just connect your aerial, ground and phones and you are ready to receive messages. Tunes to 800 meters.

Mr. Dealer: This little receiving set will help your business over the summer months and obtain new customers for you.

- Type S8 (as illustrated) price.....\$7.50
- Type S8A complete (incl. phone, aerial, insulators and instruction book)12.50

TYPE S8 SET WITH MURDOCK 2000 OHM HEADSET \$11.50



CONDENSERS

Do you know that a properly designed condenser has a great deal to do with the working of your set? Try a Radio Service Condenser and note what a difference a really good condenser makes.

- Type S15—Special Grid Condenser.....35c
- Type S16—Special Phone Condenser.....35c
- Type S22M—Mica Grid Condenser\$1.00
(Stands 1800 volts—suitable for C.W. transmission.)
- Type S30—Combination Grid Leak Condenser.....50c
- Type S40—1/2 to 3 Megohm Variable Grid Leak.....75c

SPECIAL

We have a new lot of the famous Radio Service Aluminum Dials, and only...30c Navy Cage Type Rheostats, for this month only.....\$1.50

SPECIAL

RADIO SERVICE & MFG. CO., SALES OFFICE, 110 West 40th Street, N. Y. C.
Factory, Lynbrook, L. I.

RADIO APPARATUS

Orders shipped Post-Paid and insured same day as received

VACUUM TUBES		GRID LEAKS	
UV200 Detector.....	\$5.00	G. A. condenser & grid leak.....	.50
UV201 Pilotron Amplifier.....	6.50	Radio Corp. leak complete, 1/2 1, 1.5, 2, 3, 5 meg.....	1.25
UV202 5 watt transmitter.....	8.00	Grid leak only.....	.75
UV203 50 watt transmitter.....	30.00	Base only.....	.50
Electron Relay Detector.....	6.00	MISCELLANEOUS	
Moorehead V.T. amp.....	7.00	7 strand No. 22 tinned copper antenna wire	
Double filament audiotrons.....	6.00	65 ft. per lb., per foot.....	.01
RADIO TRANSFORMERS		Ace "B" Battery, small.....	1.50
Acme unmounted amp.....	\$4.50	Ace "B" Battery large.....	2.50
Acme semi-mounted amp.....	5.00	Ace "B" Battery, variable.....	3.00
Acme full mounted amp.....	7.00	Paragon rheostats.....	1.75
Acme unmounted modulator.....	4.50	Bunnell multiple 28 ohms.....	3.00
Acme semi-mounted modulator.....	5.00	Chelsea knob and dials No. 41.....	1.00
Acme choke coil 1/2 henry.....		Remler potentiometer.....	.75
Acme choke coil 1/2 henry.....		Remler rotary lever.....	.45
Radio Corp. Transformer.....	7.00	Murdock VT sockets.....	1.00
424 Murdock Oscillation.....	5.00	Genuine Litz wire, per 100 ft.....	.50
1/2 Kw. Thordarson.....	22.50	FIXED CONDENSERS	
G. A.		Murdock No. 358.....	.35
Murdock No. 358.....		Murdock No. 359.....	.70
Remler.....		Remler.....	.90
MURDOCK VARIABLE CONDENSERS		Remler.....	.35
366—43 plate 1001 table mount.....	4.75	Murdock VT sockets.....	1.00
367—43 " 1001 " ".....	4.50	Genuine Litz wire, per 100 ft.....	.50

WHITALL ELECTRIC COMPANY

3 STEARNS SQUARE

SPRINGFIELD, MASS.



TUNERS

Our Tuners and Condensers brought in the big fight returns in great shape. They made a record.

C. W. CONDENSERS

For use up to 2000 V. now ready for distribution. New 24 page catalog brim full of phone and receiving hook-ups. New equipment. Ready—10c brings it.

TRESCO — DAVENPORT — IOWA



CONDENSERS

A Simple Radiofone Operated on Six Volts

(Continued from page 109)

The rectifiers are the two Ford headlight bulbs which each have two filaments. One filament is used as a plate, the other as a filament. Both filaments are connected outside the bulb and at the base to a common contact. This contact may be found by melting the solder, one of the wires insulated by twisting over it a piece of paper tubing and the other soldered back to the contacts; the filament connections will then be separate from each other. In the case of some bulbs, it may be necessary to burn out one filament with an over voltage and use the remaining piece as the plate. Both bulbs should be treated in the above manner.

A DeForest standard four prong base is used for a socket and a slot cut each way in it to accommodate all types of bulbs.

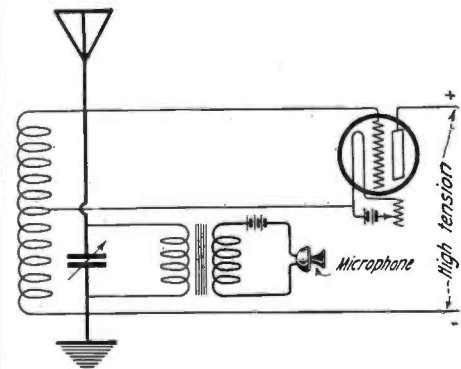
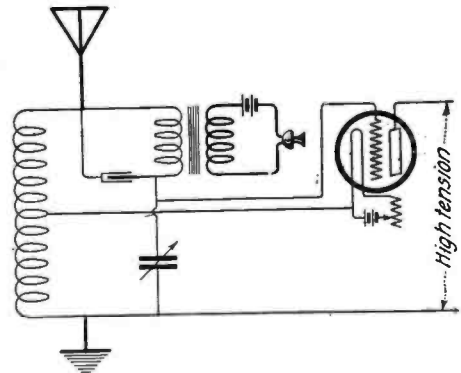

These Two Radiofone Hook-ups May Be Experimented With, as One May Give Better Results Under Certain Conditions Than the Other.

The panel is 1/4" bakelite dielecto as shown in Fig. 4. The layout is self-explanatory, and needs no further explanation. There are any number of circuits which can be used, but I found that the circuit of Fig. 5 gives the best results. I give several other hook-ups for those who wish to try them.

Adjust the shunt of the resonance indicator to give a cherry-red glow and tune the set until a maximum of glow in the lamp is reached. The set is now said to be in resonance. The microphone may be replaced by a key if so desired when tuning the set. The left hand switch is used to tune the set and the other to adjust the wave-length.

SOME TELEMEGAFONE!

Gossip—Mr. Graves, who has the wireless station across the street, has a new "loud speaker."

Wireless Brain—Magnavox?

Gossip—No, wife.

RADIO APPARATUS

*Distributors of Reliable Radio Apparatus
to Schools, Colleges and Experimenters
All Over the World!*

"PITTS CO"

SERVICE FILLS ORDERS ON
EVERY CONTINENT!

WHY NOT LET US SERVE YOU?



"PITTS CO"

SERVICE REACHES ALL OVER
THE WORLD!

WHY NOT LET IT REACH YOU?!

AMPLIFYING TRANSFORMERS

No. UV-112 Radio Corporation, new type just out. (For radiotrons).....	\$7.00
No. 226-W Federal.....	7.50
No. 231-A General Radio, new type.....	5.00

MODULATION TRANSFORMERS

No. A-3 Acme, unmounted.....	4.50
No. A-3 " semi-mounted.....	5.00
No. A-3 " fully mounted.....	7.00
No. 231-M Gen. Radio new type, just out! (for radiotrons.....	5.00

AUDION CONTROL PANELS

No. ROBH Grebe in cabinet, with tickler connections.....	17.00
No. 330 Remler, with "A" Battery potentiometer.....	8.00
No. P-1 Paragon, moulded type, very small and compact.....	6.00

"B" BATTERIES

No. 7623 Standard, 22.5 V. small.....	1.50
No. 7625 Standard, 22.5 V. large.....	2.65
No. 7650 Standard, 22.5 V. variable.....	3.50
No. 766 Eveready, 22.5 V. large.....	3.50
No. 766-A Eveready, large, variable.....	3.00
No. 763 Eveready, 22.5 V. small.....	2.25
No. P-1 "Sorsinc" new type, just out! 22.5 volts, extra long life.....	4.00

AMPLIFIERS

No. RORK Grebe two step with automatic filament control.....	55.00
No. RORD Grebe Det. and two step with automatic filament control.....	75.00
No. P-1 Amrad Type A, two step.....	39.50
No. DA Westinghouse, det. and two step, just out!.....	65.00

CONDENSERS (Fixed mica type)

No. ROCC Grebe .0002 MF.....	1.00
No. ROCD Grebe .0005 MF.....	1.20
No. ROCE Grebe .001 MF.....	1.60
No. ROCF Grebe .005 MF.....	3.80
No. ROCA Grebe .0002 MF and .5 meg. leak.....	1.20
No. ROCB Grebe .0002 MF and 3 meg. leak.....	1.20

GRID LEAKS

No. MW-1 Radio Corporation, .5, 1, 1.5, 2, 3 and 5 megohms complete.....	1.25
Grid leaks only.....	.75
Bases only.....	.50
No. 21 Chelsea, variable .5 to 5 megohms.....	3.00

MAGNAVOXES

Type R-3 Magnavox loud speaker, latest model, just out!.....	45.00
Magnavox Radiophone hand transmitter.....	28.50
Magnavox Radiophone transmitter tone-arm.....	37.50

REGENERATIVE RECEIVERS

No. CR-2 Grebe 175-680 meters.....	51.00
No. CR-3 Grebe 175-680 "Relay-special"; splendid set.....	65.00
No. CR-3A Grebe 175-375 meters with tube control, complete set.....	45.50
No. CR-5 Grebe 175-3000 meters, "Super-special" with tube control, complete set. Ideal for jewelers.....	80.00
No. CR-6 Grebe 175-680 meters, receiver, det. and two step amplifier self contained, complete set.....	200.00
No. CR-7 Grebe 500-20000 meters, "Long-wave special" with tube control, complete set. Ideal for arcs.....	210.00
No. RA Westinghouse, 180-700 meters, new type, just out!.....	65.00

PLUGS

No. 50 Pacent universal type.....	2.00
No. 1428-W Federal, brass.....	2.00
No. 1428-W Federal, silver-plated.....	2.50

JACKS

No. 1421-W Federal open circuit.....	.70
No. 1422-W " closed circuit.....	.85
No. 1423-W " Two circuit.....	1.00
No. 1435-W " automatic filament control type.....	1.20
No. 1438-W Federal Auto. filament type.....	1.50

MICROPHONES

No. 260-W Federal hand type.....	7.00
No. HM-100 DeForest hand type.....	6.00
No. 5176-A Conn. with short adjustable arm, ideal for panels.....	4.25

RHEOSTATS

No. 214 General Radio 2.5 Ampere type, just right for one UV-202 5-watt radiotron tube.....	2.50
No. 132 National Controller type, 6.4 amperes, just right for 2 UV-202 5-watt radiotrons.....	5.50
No. P-1 Paragon, very compact.....	1.75

SOCKETS

No. MW-1 Radio Corporation.....	1.50
No. 156 Gen. Radio.....	1.75
No. 550 Murdock.....	1.00
No. S-2 Radio Service double.....	2.50
No. S-3 Radio Service triple.....	3.50
No. UV-203-A Radio Corporation type for the UV-203 50-watt tube.....	5.00

RECTIFYING DEVICES

No. P-1 DeForest rectifying tubes for radio-phones work.....	7.00
No. FF France battery booster, 6 amps.....	15.00
No. P-1 Tungar 2 amp. size, complete.....	18.00
No. P-2 Tungar 5 amp. size, complete.....	28.00
No. UV-218 Radio Corp. "Kenotron".....	7.50

TELEPHONES

Type C Baldwins, Navy type.....	16.50
Type E Baldwins, ultra-sensitive.....	20.00
Type F Baldwins small, super-sensitive.....	21.00
Brandes "Superiors".....	8.00
" " "Trans-atlantics".....	12.00
" " "Navy-type".....	14.00
" " New headband only.....	1.50
" " New double cord.....	.75
Browns 4000 ohms English type.....	29.00
" " 8000 ohms English type.....	22.00

VACUUM TUBE (Radiotrons)

No. UV-200 Radiotron detector.....	5.00
No. UV-201 Radiotron amplifier.....	6.50
No. UV-202 Radiotron 5 Watt transmitter.....	8.00
No. UV-203 Radiotron 50 Watt transmitter.....	30.00
No. UV-204 Radiotron 250 Watt transmitter.....	110.00

Note. All radiotrons sent postage and insurance prepaid to any part of U. S. A. Radiotrons always in stock.

STORAGE BATTERIES

No. BX-3 Harvard 6 volts 40 ampere-hours, complete.....	16.50
No. BX-5 Harvard 6 volts 60 amp-hours.....	19.50
No. BX-7 Harvard 6 volts 80 Amp-hours.....	24.50

VARIOMETERS

No. 200 Tuska, moulded type.....	6.25
No. 200-A Tuska, moulded type with dial.....	7.25
No. 345-G Murdock grid type.....	7.50
No. 345-P Murdock plate type.....	7.50
No. 346 Murdock Vario-coupler.....	8.50
No. ZRV Clapp-Eastham Variometer with dial.....	6.50
No. ZRV-A Clapp-Eastham Variometer only.....	5.75
No. P-1 Turney's spider web inductance; ideal on radio-phones.....	8.00

POTENTIOMETERS

No. 214-C General Radio "A" Battery type, 400 ohms, ideal with radiotrons.....	4.00
No. 93 Remler "A" Battery type.....	.75
No. F-743 Clapp-Eastham "B" Battery type, 5000 ohms, fully mounted.....	3.00
" or panel mounting.....	2.50

RESISTANCE (Phone Work)

No. 1 Ward Leonard 5000 ohms.....	2.25
No. 2 Ward Leonard 10000 ohms.....	3.50

"Let 'PITTS CO' products, super-service and delivery solve your Radio problems"

SEND US YOUR ORDERS TODAY!

Send ten cents in stamps for Catalog No. 22. Over 100 pages, over 150 illustrations, over 600 items

F. D. PITTS CO., Inc.

12 Park Square

Dept. C

Boston, Mass., U. S. A.

DO YOU MAKE YOUR OWN APPARATUS? LOOK AT THESE PRICES

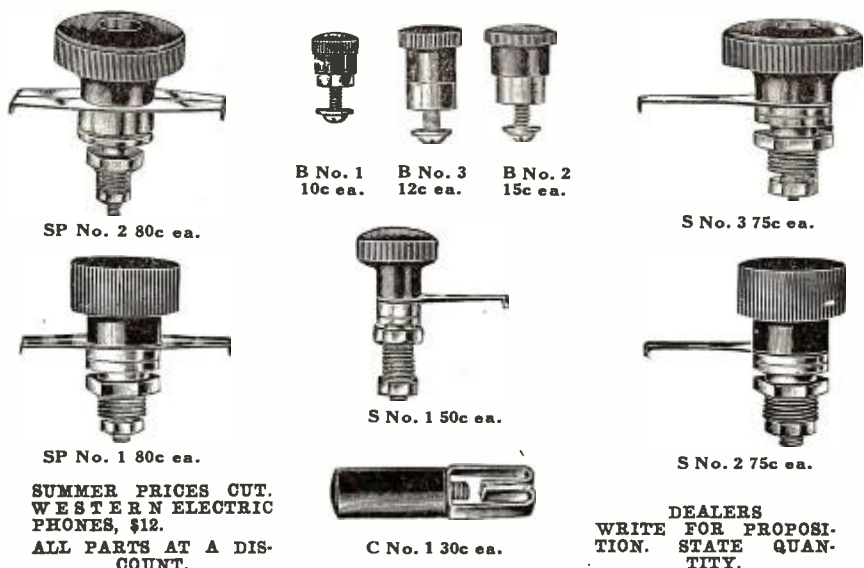

SUMMER PRICES CUT.
WESTERN ELECTRIC
PHONES, \$12.
ALL PARTS AT A DIS-
COUNT.

DEALERS
WRITE FOR PROPOSITION.
STATE QUANTITY.

American Electro Technical Appliance Co.
Dept. R 235 Fulton Street New York City



AUDIO FREQUENCY TRANSFORMER NO. 50

In general adaptability, efficiency, ruggedness, and good appearance we believe that it is superior to any at any price.

After considerable experimentation, we have produced an Audio Frequency Amplifying Transformer which we believe gives an amplification of signal surpassed by none. This has been accomplished by the proper choice of design and the use of the highest grade of materials obtainable irrespective of cost.

The transformer is of the shell type, embodying a minimum of flux leakage and hence has a negligible effect upon the surrounding circuits and apparatus, enabling a number of stages of amplification to be used in close proximity without the customary noises.

The core is composed of a large number of very thin laminations of the best quality of silicon steel. The coil winding, ratio and dimensions are designed to give the highest amplification possible with the modern type of vacuum tube. It has a square section, enabling the turns to be wound much closer to the coil than is usually possible, resulting in a considerable increase in efficiency.

Price \$4.50

The base and upper terminal block are of highly polished brass, affording the best insulation possible. Terminals are marked for proper connection and thereby eliminating all capacity effects between the primary and secondary winding, resulting in an increase of signal response of several per cent.

All connections are soldered. The entire instrument is moisture proof and cannot be injured by rough handling. Can be mounted in any position and has practically an infinite life. This transformer is extremely light, compact and efficient and its beautiful appearance makes it a big asset in any radio station. The price is unusually attractive.

Purchased Chelsea apparatus from your Dealer.

Bulletin sent upon request.

CHELSEA RADIO CO., 17 Fifth Street, Chelsea, Mass.

WIRELESS

You should have it even if only superficially interested. Around about you every day you read of some marvelous occurrence in which wireless played a distinguished part. It may not be entirely clear to you. The Manual will explain it. To the student of Wireless Telegraphy, the Manual contains much that is indispensable to a proper understanding of the art.

It contains 200 pages, fully illustrating and describing the many instruments used in Radio. 45 pages cover general instructions, diagrams, station calls, tables, codes and other information.

The book is printed on highly finished paper with a two-color cover and measures 9 x 5 1/4 inches.



MANUAL M12

Containing as it does a fund of valuable information not generally contained in a catalogue, it approaches nearer a text book in the fascinating field of wireless telegraphy. No expense has been spared to make it accurate and reliable.

No Wireless Experimenter Should be Without the Mesco Wireless Manual. We ask 25 cents (25c) for it—give you a coupon receipt which can be applied on any future order.

Send your name and address now, and get one of the most complete, comprehensive and reliable wireless books published.

MANHATTAN ELECTRICAL SUPPLY CO. INC.

17 Park Place
New York

114 S. Wells St.
Chicago

1106 Pine St.
St. Louis

604 Mission St.
San Francisco

J. E. Armstrong's Station

(Continued from page 121)

teurs, the music and voice being loud enough to be audible all over the room. The switches seen on the back panel are to change from the large coupler to the variocoupler, and another switch to change from crystal to audion detector. In the upper left-hand corner of the picture may be seen a loud talker, made from an old fonograf horn and a pair of Murdock fones. It brings in the signals and music loud enough to be heard anywhere on the second floor, where my set is located.

The sending set consists of an oscillation transformer, condenser, two-inch coil and gap. I have not used this set, as I have not yet applied for my license, but expect to do so in a very few days.

Radio Frequency Ammeters

(Continued from page 107)

$$\frac{i_1}{i_2} = \frac{R_1 + 2\pi f L_1}{R_2 + 2\pi f L_2} = \frac{\left[1 + 2\pi f \frac{L_1}{R_1} \right] R_1}{\left[1 + 2\pi f \frac{L_2}{R_2} \right] R_2} = \frac{R_1}{R_2}$$

when $\frac{L_1}{R_1} = \frac{L_2}{R_2}$

If the wires are the same then the terms $\frac{L_1}{R_1}$ and $\frac{L_2}{R_2}$ are equal, and consequently the expressions in the brackets are equal and cancel each other. Thus the currents are proportional to the resistances of the wires, and these are made so thin that the frequency has no effect. Therefore, the objection of the shunt does not hold when the hot wires are alike, as they can be made to be.

Thus a number of similar hot wires may be connected in parallel and thereby the current range of the ammeter may be increased. However, for accurate results when a number of hot wires are connected in parallel another precaution must be observed. When a number of hot wires are connected in parallel a factor which we have thus far neglected comes into play, namely the mutual inductance between wires. Altho this mutual inductance may be small it is important to take into account, as it may influence the reading a very appreciable amount. The terms involving the mutual inductance will also contain the frequency and unless care is taken, the reading will vary with the wave-length. This possible source of error can be eliminated by connecting the wires in a certain way.

If the hot wires are connected in the same plane as in Fig. 2, then the distance of each wire from the others will vary, and be different, there will be no symmetry in the distances of each wire from the others. Consequently the mutual inductance between each wire and the others will likewise vary and there will be no symmetry in the mutual inductance figures. As a result, they will not be able to cancel each other, as the self-inductances did above, and the reading of the ammeter will be unreliable, due to variation with the frequency. However, if the hot wires are connected as elements of a cylinder, each wire being equidistant from the other, as in Fig. 3, then the distance of one wire from that of the others respectively will be duplicated by all the other wires, there will be a symmetry in these distances, and the mutual inductance of one wire with respect to all the others will be also duplicated by the mutual inductances of the other wires. Consequently these mutual

"The Greatest Radio Catalog In the World" —

The Universal Verdict of Tens of Thousands of Radio Amateurs

Duck's Big 225-Page Wireless Catalog

Mailed upon receipt of 12c in stamps or coin. This catalog is a veritable treasure house of everything worth while and dependable in radio. It is the largest and most comprehensive, artistic and educational radio catalog published.

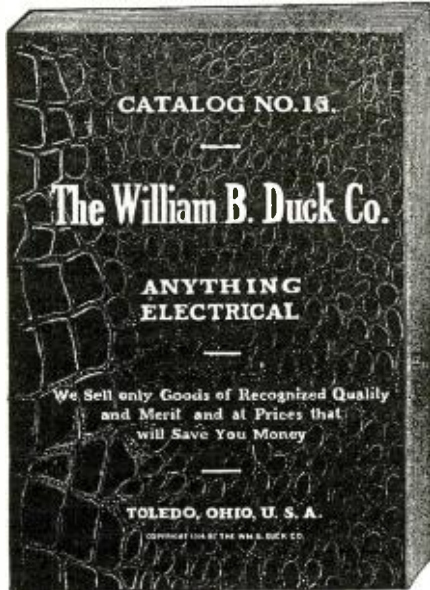

Substantial Reductions on many Radio Instruments that appear in Catalog No. 15

The prices of DeForest Honeycomb Coils and all DeForest instruments as set forth in catalog No. 15 have since been reduced to the previous DeForest list which appears in the first edition of our catalog No. 14.

No. R40 Receiving Set	\$22.50
No. R41 Receiving Set	\$8.50
No. R41a Receiving Set	28.50
THORDARSON TRANSFORMERS	
1 K.W. Type R	40.00
1/2 K.W. Type R	28.00
1/4 K.W. Type R	22.00
1 K.W. Type RS	30.00
1/2 K.W. Type RS	20.00
1/4 K.W. Type RS	15.00
No. A1792 Thordarson Condenser	25.00

Nos. 50, 51, 52	
Switch Contacts, each	.03
No. 1023 Mica Condenser	.80
No. B670 Detector	2.75
No. A862 Detector	2.75
No. A1915 Detector	1.50
No. A367 Murdock Condenser	4.50
No. A1002 Receiving Set	9.75
No. A1916 Condenser	1.63
No. 61x08A Tuning Coil	2.95
No. 61x10 Tuning Coil	4.95
No. 14 Aluminum Wire, per lb.	.90
All Binding Posts reduced 33 1-3%	

Only a few of the many New Instruments in Catalog No. 15

Type C-300 Cunningham Bulb	5.00
Type C-301 Cunningham Bulb	6.50
UV-200 Radiotron Bulb	5.00
UV-201 Radiotron Bulb	6.50

A Complete Line of New Detector, Regenerative and Amplifying Sets	
Connecticut Variable Condenser	6.50
Turney Spider-Web Unit	6.00
No. 550 Murdock Socket	1.00
No. 3660 Murdock Condenser	4.00
No. 3661 Murdock Condenser	4.25
No. 3662 Murdock Condenser	5.00
No. 3663 Murdock Condenser	3.25
No. 3681 Murdock Condenser	3.50
No. 3682 Murdock Condenser	4.25
No. 3684 Murdock Dial Assembly	1.25
MC-1 DeForest Set	40.00
MC-2 DeForest Set	59.00
MR-1 DeForest Set	85.50
MR-2 DeForest Set	85.50
MR-3 DeForest Set	105.00
MS-2 DeForest Set	209.00

Note: The above DeForest Sets are just out and constitute panel detectors, amplifiers, regenerative receivers and complete radio telephone transmitting and receiving sets. The various sets above mentioned comprise the various units in sets. These units may be bought separately and later added to.

No. MS-2 comprises a complete Midget Radiophone with a thirty-five mile speaking range, regenerative receiver; also receiver for wave lengths of 25,000 meters, and a detector and two-stage amplifier each in separate units but all mounted in a mahogany cabinet.

Type OF-3 Midget Radiophone consisting of antenna circuit panel and power tube panel	\$95.00
Microphone, extra	6.00
Power Tubes, extra	22.50
Magnavox Radiophone Hand Transmitter	22.50
Magnavox Radiophone Transmitter Tone Arm	37.50
Magnavox Loud Speaker	45.00

DUCK'S No. 15 BIG 225 PAGE WIRELESS CATALOG. JUST OUT

A Veritable Treasure House of Everything Worth While and Dependable in Radio. The largest, most comprehensive, artistic and educational wireless catalog published. The Beacon Light to guide you right in the selection of your radio purchases, and at prices that will command your attention. Every instrument guaranteed with privilege of return if not satisfied.

For 12 Years the Name "DUCK"

has had a meaning all its own to radio amateurs.

Next month we shall reproduce a number of late testimonials out of thousands pouring in upon us, which will tell you why the overwhelming majority of radio amateurs buy from "Duck."

Ever since the year 1909 Duck's catalog has always occupied the foremost rank among radio amateurs; in each succeeding year, with the constant development of radio this catalog blazed the way with most everything new and dependable listed between the covers of all other catalogs. It has truly been a "BEACON LIGHT" to the novice and the expert in radio. In keeping with the size and completeness of this catalog there has always been a stock of radio instruments in our place many times larger than that of any other radio house; in fact we believe several times larger than the next largest. Our many years in this business and the immensity of our stocks is conclusive proof that you are dealing with a big, well-established and dependable concern.

SERVICE

Among many other things, has made our business tremendous, and except for a limited time after the war, when without actively inviting the business we were literally snowed under with orders, our service has always been our pride and the delight of radio amateurs. SERVICE—the most abused word in advertising and the hardest and most complex thing to give to radio experimenters. We do not tell you that we can always ship every item in our catalog immediately, but our records for some time past prove that we are giving our pre-war service and shipping 98% of all orders complete within twenty-four hours after receipt.

New Short Wave Regenerative Set with Detector

Listen in to the Radio Concerts with this wonderful receiver.



For damped and undamped stations from 150 to 600 meters. Variometer and vario coupler construction. Variometer coupling extremely close giving maximum inductance. Vario-coupler primary provided with single and multiple tap switches giving extreme selectivity. Wiring bus bar type insulated with oiled cambric tubing. Brushed Bakelite panel. Beautifully finished mahogany cabinet. Tested before shipment in Toledo for radio music from Pittsburgh and Washington. Absolute certainty of getting what you buy. The maximum range obtained from any type of transmitting station, damped or undamped, using up to 600 meters. We unqualifiedly guarantee that there is nothing like it on the market for the price.

No. A204 New Short Wave Regenerative Set with Detector and "B" Battery.....\$65.00
Cunningham or Radiotron Detector Bulb, extra..... 5.00
No. A210 Short Wave Regenerative Receiver only (style, construction and appearance same as No. A204, but without detector)..... 50.00



No. A200

An excellent Audion Control Panel for use with new four-prong bulbs. Grid leak and grid condenser are mounted on rear of panel. New type panel rheostat mounted on center of panel. The formica panel is attached to a wood base, upon which is mounted the tube receptacle.

"B" Battery control permitting of four regulations of "B" Battery. Voltage from 18 volts to 22 1/2 volts in steps of 1/2 volts. A fine adjustment of "B" Battery is necessary for the best results.

No. A200 Panel Detector Set, less batteries and bulb.....\$7.50
No. A201 Cabinet Detector Set, with batteries less bulb.....15.00
No. A202 Cabinet Detector or Amplifier Set, with Batteries less Bulb.....\$22.00

Duck's Big Summer Sale is Now On

Send for pamphlet illustrating and describing the biggest bargains ever offered in the history of radio on countless radio instruments, including many complete receiving sets, regenerative sets, panel detector sets, detector and amplifier sets, Navy and Arlington receiving transformers and other items.

THE WILLIAM B. DUCK CO., 231-233 Superior St., Toledo, Ohio

POPULAR DEMAND



Results in our placing before the Amateur the parts of the now famous "CINO" Regenerative Tuner, made Nationally famous in sixty days!

- Variometer Forms only\$2.50
(2 Stators, 1 Rotor and winding form.)
- Variometer wound, not assembled..... 4.50
- Variometer completely assembled..... 6.00
- Variocoupler parts 2.50
- Variocoupler completely assembled..... 6.50
- Formica panel drilled and engraved..... 5.00
- 14 Contacts......56 2 Switches..... 1.20
- Option of Corwin or Chelsea dials at list.
- CROSLY PORCELAIN SOCKET60
- Winding specifications and drawings furnished.



CINO RADIO MFG. COMPANY
218 WEST 12th STREET
CINCINNATI, OHIO

PRICE REDUCTION OF TUBE SOCKET



TYPE 156 SOCKET

The ever increasing demand for our universal tube socket has enabled us to reduce the cost of manufacture and correspondingly the sale price. The same high quality of material and workmanship will be rigidly adhered to.

These sockets are adapted to any of the standard American four prong transmitting or receiving tubes. They are adapted to the Western Electric VT-2 tubes as well as to the Radiotron UV202 tubes. The contact springs are sufficiently rugged to carry the filament current of the five watt transmitting tubes without arcing.

POSITIVE CONTACT SPRINGS
RUGGED ATTRACTIVE RELIABLE

PRICE \$1.50

SEND FOR FREE RADIO BULLETIN 909N

GENERAL RADIO COMPANY

MASSACHUSETTS AVENUE AND WINDSOR STREET

CAMBRIDGE 39

MASSACHUSETTS

Standardize on General Radio Equipment Throughout.

MIGNON-SYSTEM WIRELESS TELEPHONE

Write for Literature describing
LATEST DEVELOPED
RADIO APPARATUS
IT'S FREE

MIGNON SYSTEM MFG. CO.
BUFFALO, N. Y., U. S. A.



READ the CLASSIFIED ADVERTISEMENTS on PAGES 172-174 YOU'LL FIND MANY GOOD THINGS THERE.

inductances will cancel each other exactly in the same way the self-inductances did above and the error due to frequency will be eliminated.

Finally, for measurements of extremely high currents such as the antenna currents of high power transmitters it is apparent that the ammeter elements must have much larger areas to carry safely these heavy currents. This is accomplished by the use of metal strips connected in parallel as the hot wires are. These strips must also be very thin in order to avoid variation in resistance due to frequency, and should be connected for minimum errors in cylindrical fashion as the hot wires are.

It is thus seen that the radio frequency ammeter is subject to a great many sources of error and must be very carefully designed to eliminate these. Even with the use of such carefully designed and constructed meters there is possibility of incorrect readings, especially at high frequencies. Inasmuch as the amateur works at around 20 meters in his transmission, it is pertinent to discuss this a little more fully. When his ammeter indicates one ampere or two, this reading may not be an indication at all of the current in his antenna. This will be evident to him if he connects his ammeter in different parts of the antenna circuit, for he will find that the readings will be very different. Consider the typical circuit as in Fig. 4. Around his loading coil and other apparatus in the antenna circuit thru which the current flows there will always be found numerous other instruments not connected to the antenna. There will therefore exist a capacity from the different parts of the antenna circuit to these disconnected instruments and to ground, etc. At the very high frequencies at which the amateur transmits, these stray capacities have a very low impedance and the current just leaks from the different parts of the antenna thru these capacities, thus shunting off some of the antenna current which portions may never flow thru the ammeter. In the hook-up of the circuit, therefore, care must be taken in the placing of instruments, and an effort should be made to keep these possible leakage paths at a minimum.

Operation of Vacuum Tubes in Parallel

(Continued from page 106)

L_1 be the grid inductance for one tube.

L_2 be the grid inductance for n tubes. i is the output current of one tube.

$Vn i$ is the output current of n tubes.

ω is the frequency of the oscillations.

$$E = \omega L_1 i$$

$$E = \omega L_2 Vn i$$

$$\therefore \omega L_1 i = \omega L_2 Vn i$$

$$\therefore L_1 = Vn L_2$$

$$\text{or } L_2 = \frac{L_1}{Vn}$$

which shows that the grid tap or inductance for one tube is equal to the square root of the number of tubes times the grid tap for n tubes, or that the grid tap is inversely proportional to the square root of the number of tubes oscillating in parallel. Likewise it can be shown in slightly different manner that the plate tap varies in the same manner.

Thus it is apparent that when tubes are operated in parallel as primary oscillators a wide latitude in the choice of taps is not possible. In the oscillator system it is not necessary that the plate and grid taps be carefully chosen, otherwise there may not be sufficient reaction between plate and grid to set the valve oscillating; or the grid a. c. voltage may be such that the negative potential is higher or lower than required by the individual tubes; or the plate tap may be such as to give the oscillatory circuit an

NOW IS THE TIME TO MAKE BIG MONEY

LEARN WIRELESS

AT HOME

**Know a Dignified
Uncrowded Profession**

**In Shortest Time
At Lowest Cost**

The Demand for Good Wireless Operators Far Exceeds the Supply

The New York Wireless Institute—America's foremost fastest growing Wireless Institute gives you the best instruments, theory, text books and diagrams available. We will MAKE YOU AN EXPERT WIRELESS OPERATOR AT HOME, qualifying you for first grade license, in your spare time, easily, thoroughly, in shortest possible time and at lowest cost. No previous training is necessary. Our Home Study Course is prepared by Mr. L. R. Krumm, formerly Chief Radio Inspector, Bureau Navigation, New York, now in position of greater responsibility with one of the largest Commercial Radio Corporations in the United States. Our Radio Experts, able to impart their practical and technical knowledge to YOU in an easy to-understand way, will direct your entire Course. The graded lessons mailed you will prove so fascinating that you will be eager for the next one. The instruments furnished free will make it as easy for you to learn the Code as it was to learn to talk. *All you will have to do is to listen.*

BIG SALARIES

Wireless operators receive salaries from \$125 to \$200 a month and it is only a stepping stone to better positions. There is practically no limit to your earning power. Men who but yesterday were Wireless Operators are now holding positions as Radio Engineers, Radio Inspectors, Radio Salesmen at salaries up to \$5,000 a year.

TRAVEL THE WORLD OVER

A Wireless Operator can visit all parts of the world and receive fine pay and maintenance at the same time. Do you prefer a steady position without travel? There will be many opportunities for you at the numerous land stations or with the Commercial Wireless or with the Steamship Companies.

The New Intercity Wireless Company will need hundreds of new operators

INSTRUMENTS AND TEXT BOOKS

We furnish free to all students, during the Course, the wonderful receiving and sending set exactly as shown in the illustration. This set is not loaned, but given to all students completing the Course. One cell of dry battery all that is required. No additional wiring, aerials, etc., needed. The wonderful Receiving and Sending Set, Text Books, etc., all become your property upon completing the course.



FREE

The transmitter pictured is the celebrated Omnigraph, used by several Departments of the U. S. Government and by the leading Universities, Colleges, Wireless and Technical Schools throughout the United States and Canada. Thousands have learned telegraphy with the Omnigraph. Place the phone to your ear and this remarkable invention will send you wireless messages, thousands of different ones, the same as though you were receiving them thru the air from a wireless station hundreds of miles away. When you apply for your license the United States Government will test you with the Omnigraph—the same model Omnigraph as we furnish to our students. Ask any United States Radio Inspector to verify this.

FREE WIRELESS TELEPHONY COURSE

We have incorporated in our Institute an up to-date and Complete Course in Wireless Telephony, written by our Chief Instructor, Mr. L. R. Krumm.

This Course is included FREE

FREE POST GRADUATE COURSE

A month's Post-Graduate Course, if you so desire, at one of the largest Wireless Schools in N. Y. City—the Wonder City—the largest port in the World and Headquarters of every leading Wireless and Steamship Company.

Endorsed by United States Government

by allowing our graduates highest credit given any Wireless Correspondence School in first grade license examinations.

U. S. SHIPPING BOARD will testify to the value of our instruction.

Medina, N. Y.,
November 28, 1920.
Dear Sirs:—
I have found the Theory Course, the Omnigraph Set and Text Books most satisfactory.—I think your Wireless Course is the best and easiest to learn for it's interesting from the beginning to end, and the way the questions are written gets you interested once.
Yours Truly,
(Signed) S. B.

Sea Cliff, L. I.,
December 6, 1920.
Dear Sirs:—
Received your letter of December 1, and was very pleased to learn of the lessons in Wireless Telephony to be given to the students of your school. It shows you do not overlook any phase in order to furnish the students with "up to date dope in the Radio line". And I am sure it will be as explicit as your Theory course of Wireless Telephony.
The course is as thorough and explicit as one could ask for and I wouldn't hesitate a moment in recommending it to any of my Radio friends.
Respectfully yours,
(Signed) C. D. H.

Milford, Conn.,
Oct. 25, 1920.
New York Wireless Institute,
New York City.
Dear Sirs:—
I received your letter and am very glad to tell you that I am completely satisfied with your course. It sure is an easy way to learn.
Thanking you for your kind attention,
I am,
Sincerely yours,
(Signed) J. H. A., Jr.

(Names and address gladly furnished on application.)

NEW YORK WIRELESS INSTITUTE

Dept. 204, 258 Broadway New York City
Send me, free of charge, your booklet "How to Become an Expert Wireless Operator," containing full particulars of your Course, including your FREE INSTRUMENT OFFER.

Name

Address

City or Town

State

SEND FOR FREE BOOKLET

Without obligating you in any way, send for our booklet "How to Become an Expert Wireless Operator"—it is free. Mail the coupon opposite or postal or letter—but do it today.

NEW YORK WIRELESS INSTITUTE, Dept. 206
258 Broadway
New York City

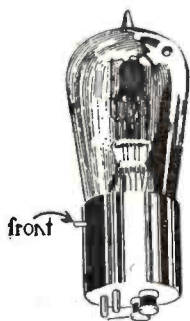

A New Advance In Wireless

You can feel a sense of absolute security, when you protect your Vacuum Tubes with "RADECO" Safety Fuses. No matter what abnormal amperage is set up—or how, it is IMPOSSIBLE to burn any bulb filament out accidentally when you have "RADECO" Safety Fuses on the filament terminals.

"RADECO" Safety Fuses are used by thousands of Radio men, both amateur and professional, in the United States and Canada.

At a few cents cost this small device prolongs the life of any Vacuum Tube indefinitely. SIMPLE! just slip fuse directly on the filament terminals of any standard bulb used in any standard socket. The "RADECO" Safety Fuse does not reduce the efficiency of your set.

RADECO Safety Fuses may also be used to protect meters and any other delicate electrical instruments.

We sell standard Radio equipment of every description. Order from any standard catalog. Immediate deliveries.

Carrying Capacity
 ¼, 1, 1¼, 1½, 2, 2½ and 3 amp. Size ¼ inch over all.

Order by Mail

If your dealer cannot supply you with "RADECO" Safety Fuses pin one dollar to this advertisement, stating sizes wanted, and receive four fuses by return mail.

RADIO EQUIPMENT CO.

630 Washington St.
 BOSTON, MASS.

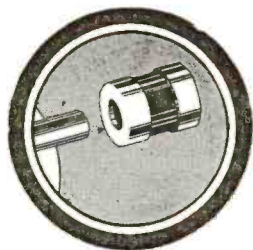

"RADECO" Safety Fuse

(Patent Pending)

You are far behind the times and OPEN EVERY MINUTE TO LOSS if your set is not equipped with a RADECO Safety Fuse. See your dealer today.

Sold by dealers, 4 for **1⁰⁰**

The New RTS Bushing Lever

After a careful study of all the switch levers now manufactured, we have produced the new RTS SPECIAL LEVER.

This lever has all the new improvements and will equal or excell all other types selling at double the price.

SPECIFICATIONS

- KNOB—Large Marconi 1¼" diameter.
- LEVER—Special Alloy, heavily nicked 1½" radius.
- GUIDE BUSHING—¾" diam., ¼" thick—Nickle plated.
- PANEL BUSHING—Panels up to ½" thick can be used.
- ADJUSTMENT—Obtained by 2 nuts on long rod.

SEND FOR CATALOGUE

RADIO TESTING STATION BINGHAMTON, DEPT. 1 NEW YORK

AND THE PRICE

58c



effective resistance so far removed from the valve resistance as to prohibit oscillations. In other words, for generating oscillations the various adjustments are critical within limits and this criticalness increases with the number of tubes oscillating in parallel.

As far as telegraphy goes this is perhaps the largest difficulty. When telephony is introduced, a further difficulty is experienced in operating tubes in parallel as oscillators, namely the method of modulating these oscillators. With vacuum tube sets the results of all investigators point to the constant current, plate-injection modulating system as the best. In certain cases, particularly with low power sets, grid modulation sometimes proves as satisfactory or the insertion of the microphone in the antenna has some advantages. But for the higher powers it will be found that the plate injection method is the only feasible one. But if a number of tubes are oscillating in parallel this method requires as many modulating tubes in parallel as there are oscillators. Thus for a given output the number of tubes is increased to twice the number of oscillators, and the set becomes bulky and upkeep and replacement of tubes decreases the economy efficiency.

Thus it is necessary to resort to another method of operating tubes in parallel, namely method number two, master oscillator and amplifier system. This method, shown diagrammatically in Fig. 2, provides one master oscillator tube oscillating at maximum output, which provides either by inductive or conductive coupling an exciting radio frequency voltage to the grids of the amplifier tubes connected in parallel. The amplified output appears in the plate or antenna circuit. Here it is necessary to adjust the master oscillator for the best output or approximately so, which affords no great difficulties. The radio oscillations being generated by the master oscillator it is only necessary to apply the necessary grid voltage to the amplifiers and the oscillations will be repeated in the plate circuit.

The grid voltage thus chosen will have a best value depending upon the characteristics of the amplifier tubes, but even if the tubes differ slightly in their mechanical construction there will not be the difficulty that exists in the parallel operation of tubes as oscillators. For the grid voltage is generated by an external source and exists regardless of the amplifier tubes. If the grid voltage chosen does not exactly fit a given amplifier tube it simply means that the tube will amplify the input but the amplified output will not be the maximum the tube can give. But they will all give an amplified output, whereas in the oscillator scheme the circuit may not oscillate due to the necessity of reaction from plate to grid circuit. In the amplifier system there is no necessity of reaction between plate and grid circuit. The plate circuit must be adjusted as in the oscillator method for maximum output, but as in the grid tap, if there is a tube which the plate tap does not exactly fit it means that that tube will give a lower amplified output than it is capable of giving, but each tube will give its share of output.

This method simplifies the problem of modulation for telephony. Since there is but one master oscillator tube whose output is amplified by the bank of amplifiers, it is evident that if the output of the master oscillator can be modulated then this modulated output can be amplified by the bank of amplifiers. The master oscillator can then be modulated by any of the operable systems, preferably the constant current system, and this modulated output applied to the amplifier grids, the output in the amplifier plate circuit being then the modulated oscillations of the required power. This scheme is shown in Fig. 3. This method is the best and most practical one from an engineering point of view.

In operating a master oscillator-amplifier set certain false results must be carefully guarded against. One frequently hears of the remarkable outputs and efficiencies

which are obtained with the amplifier systems, but on more careful examination it will be found that some of the apparent antenna current is really not antenna current but useless capacity current. Capacity currents are very elusive, and if care is not taken they are bound to crop up in the most unexpected places. A small amount of capacity coupling between the amplifier and master oscillator circuit may result in these parasitic currents flowing between these two circuits, and if the ammeter position is not carefully chosen it will indicate these currents and apparently show a high output. Or if the inductively coupled circuit is used between amplifier plate and antenna, care must be taken in the design of the plate-antenna transformer, that the distributed capacity between primary and secondary is low. Otherwise there will be leakage currents from primary to secondary thru the dielectric of the transformer, which current may be indicated on the ammeter and some more apparent radiation marvels produced. The trouble with these currents is that altho they affect the ammeter they do not flow thru the antenna and thus do not enhance the radiation effect. No fixt rules can be given for the avoidance of these leakage currents or for their detection. The individual cases must be given careful and critical attention and the ingenuity of the engineer or operator relied upon for their detection and elimination.

Another trouble sometimes encountered with the master oscillator-amplifier system which must be avoided is self-excited oscillations of the amplifier bank. The amplifier bank should be used strictly as amplifiers and nothing else. But since all tubes have capacity coupling between grid and plate inside of the tubes, it sometimes occurs that there exists enough internal coupling and external coupling to cause the amplifier bank to oscillate. This can be very easily detected by extinguishing the filament of the master oscillator only, and if the amplifier tubes are oscillating the antenna current will persist. This is to be avoided, for otherwise the object of the amplifier system is nullified. The self-oscillations of the amplifier bank can be eliminated either by reducing the grid tap or inductance in the amplifier grid circuit, thereby reducing the coupling between plate and grid or by the insertion of resistance in proper parts of the amplifier circuit, thereby killing the oscillation properties of the circuit. The latter method is preferable, as the former method means that the optimum value of grid inductance can not be chosen and thus the maximum output of the amplifier is not attainable.

Another precaution to be observed on the use of the master-oscillator-amplifier system is the method of coupling for securing the necessary voltage for the amplifier grids. Figs. 2 and 3 show how this voltage is secured by inductive coupling to the master oscillator coil, and that the coupling is made on the plate side of the master oscillator coil. It is best to couple to the plate side and not the grid side of the coil. The grid circuit of a tube is more sensitive to small changes than the plate circuit, of course, and consequently it is preferable to couple the amplifier to the plate side, and so avoid any possible trouble with the master oscillator.

The relation between the output of a number of oscillators in parallel and one oscillator is quite simple. If one tube delivers an output of P watts then n tubes in parallel will deliver an output of nP watts, that is, the output varies directly as the number of tubes. If one tube delivers a current of I amperes, then n tubes will deliver a current of nI amperes, that is, the output current is directly proportional to the square root of the number of tubes. A similar relation holds, of course, between the output values of a number of amplifier tubes and one amplifier tube.

"The Promised Land"— YOUR OPPORTUNITY

"The Promised Land" is the name professional operators have given to the New York Central Radio Station of the Radio Corporation of America on Long Island, which, when completed, will be the largest and most powerful radio station in the world.

This immense station which is now in course of erection, is a striking example of the great opportunity radio offers you for a successful, secure future. It will be equipped to work simultaneously with five other nations in widely separated and distant parts of the world and will be epoch-making in the field of international communication.

A large number of trained men will be required for its operation and maintenance. A position at this station is the height of every operator's ambition, for it means unlimited opportunity to succeed and progress to higher, more responsible and better paying positions in the radio industry. So far as opportunity goes the successful future of these men is assured.

HOW ABOUT YOU?

Right now, today, radio offers you big opportunities—if you are properly trained. Radio companies need trained executives, engineers, draftsmen, operators and mechanics. Hundreds of positions in the ever-broadening field—from ship operator to general manager—are open to you, if you have the required training. The Radio Institute of America will give you this training, as it has to thousands of others. If you cannot come to the Institute, the instruction will come to you—to your home.

This new home course of radio training, which has been developed for the benefit of those who cannot attend the Institute personally, is the same course used at the Institute. It includes everything from basic principles of electricity and magnetism, to actual operation of commercial radio equipment. It also includes the same textbooks used in the Institute classes, as well as an Omnigraph set of greatly improved design, with a variable automatic transmitter, for code practice.

What Our Former Students Are Doing

Mr. H. Payne, former student, now Assistant Treasurer of the Radio Corporation of America.

Walter E. Wood, Superintendent in charge of the powerful trans-oceanic radio station at Chatham, Mass.

Irving Ellingham has a greatly prized position in his assignment as radio operator on Vincent Astor's yacht "Cristina."

Raymond Blanquet, although only 20 years old, is now a high salaried operator in trans-oceanic service.

Watson Sidney, Manager of the office of the Radio Corporation of America, Savannah, Ga.

Harry Sadenwater, assistant in research in the world-famed radio laboratories of the General Electric Company.

E. N. Pickereil, manager of the Radio Corporation's shore station for the port of New York.

Lee L. Manly, assistant superintendent in the Maintenance Department of the Radio Corporation.

William S. Fitzpatrick, Assistant Marine Superintendent.

The graduates of the Radio Institute of America enjoy a great and exclusive advantage in the close connection existing between the institute and the Radio Corporation of America, world's largest radio manufacturing and commercial radio company. The Radio Corporation employs thousands of men, in its executive departments on ships and at shore stations and in factories and laboratories. A large percentage of these men are graduates of the Institute.

What the Man Who Employs the Operators Says:—

Radio Institute of America,
New York.

Gentlemen—I have known the Radio Institute of America so long and so favorably under its present title and its earlier name, Marconi Institute, that it is difficult for me to conceive that anyone can think of instruction in radio without instantly recognizing its leadership. When employing operators, your students are given preference because several thousand of them have proven their ability to me over a long period of years.

Sincerely yours,
(Signed) J. B. DUFFY,
Superintendent, Eastern Division, Radio Corporation of America

The Radio Institute of America has been an established and successful institution for over fifteen years. The year round average attendance in its classrooms is now 298 students per month. It has trained over 6,000 men, 95% of whom have successfully engaged in this new branch of science and industry. You, too, can be successful in this new field if you properly train yourself by means of the Home Study Course of the Institute. Radio offers an unlimited opportunity for future advancement—why not take advantage of it. Write for our booklet and further details.—NOW.

HOME STUDY DIVISION

RADIO INSTITUTE OF AMERICA

(formerly Marconi Institute)

324 BROADWAY, NEW YORK

Just What You Have Been Looking For!



MARVEL Radio Receiver Model 101

A compact, efficient, simple, radio receiving set. No batteries or other expensive renewable parts needed.

Wavelength range 180 to 2500 meters on small antennae.

It is not necessary to have a high, complicated antenna structure to receive radio signals with this set. Just connect a single aerial wire to the set, ground one terminal, and connect phone to the other terminals and you are all ready to receive all kinds of radio signals: messages from amateur stations, ships, wireless telephone speech and music, time signals, weather reports, press, etc.

Just the set for use on long hikes, in camps, on motor-boats, etc. No parts to break or to be renewed. Weight—only 12 ounces, dimensions 4 x 4 x 3 1/2 in.

"MARVEL" Radio Receiver, Model 101, with instructions and code chart, as illustrated, postpaid.....\$8.00

COMPLETE "MARVEL" Radio Receiving Outfit. Model 105, consisting of a Model 101 "MARVEL" Radio Receiver, 150 ft. antenna wire, 5 porcelain insulators, ground switch, telephone with leather covered headband and telephone cord, instruction book and code charts, all put up in an attractive box, postpaid.....\$15.00

Either of the above sets sent anywhere in the U. S. postage prepaid, upon receipt of money order or check; sets will also be sent via Parcels Post. C. O. D.

LOOK FOR THE REGISTERED TRADE MARK ON EVERY GENUINE "MARVEL" RADIO RECEIVER; OTHERS ARE IMITATIONS.



DEALERS: We are looking for several well established dealers to sell these sets in the various sections of the country. "MARVEL" Radio Sets will be widely advertised, and should prove to be a "best seller" in the fall and around the Holidays.

RADIO MANUFACTURING COMPANY
Executive Offices, 156 Fifth Avenue New York, N. Y.

"CHI-RAD" VARIOMETERS AND COUPLERS

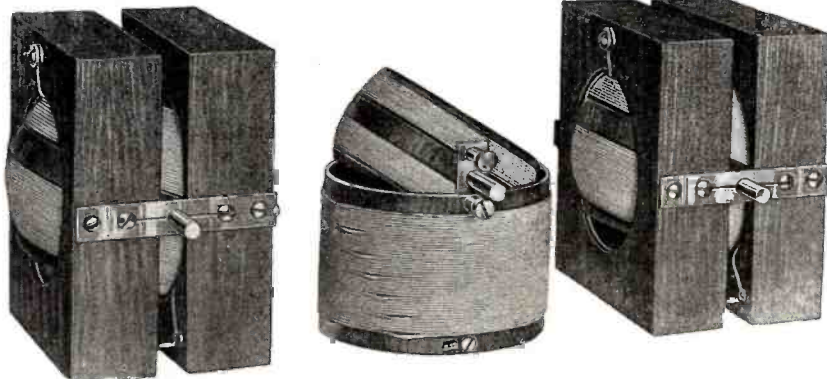

Variometer, P-1 \$5.00 (3 lbs.) Coupler, C-1 \$4.00 (2 lbs.) Variometer, G-1 \$5.00 (3 lbs.)
Prices, completely assembled as shown. Include PP on weight given. Chelsea Dials, \$1.00 each.

SPECIAL KNOCKED DOWN PARTS

The knocked down set includes all parts to make up two variometers and one coupler exactly as shown above. All windings in place, nothing to do but screw on bearings and connect up. Set can be completely assembled in 30 minutes. Price complete only \$10.00. Add PP on 6 lbs. Immediate delivery—the biggest value on the market—order your set today!

Read these specifications:
Variometer forms 4 1/4" sq., 3" wide when assembled. Coupler primary Bakelite, 3/8" Diam. 3 3/4" high. All shafts 3/4" diam. Designed specially for panel mounting—all screws covered by dials when assembled. Range 175-450 meters. Special condenser to shunt across secondary and increase range to 650 meters 35c extra.

CHICAGO RADIO APPARATUS CO., Inc.
508 SO. DEARBORN ST. (Phone Harrison 1716) CHICAGO, ILL.

A REAL BARGAIN

Send your order in today. Cuts approximately full size.



No. 60 binding post, polished nickel with knurled hard rubber top
was 12c now **08c.**



No. 110 switch lever, polished nickel with finely knurled knob. Bushing also furnished with this lever
was 60c now **45c.**

DAVID KILLOCH COMPANY
57 Murray Street New York

The question of the relative values of the output obtained from amplifiers compared to that obtained from oscillators is of some consequence. This question has been raised by Mr. Blatterman in the February, 1921, issue of the RADIO NEWS in an article on "Notes on Modulated Tube Transmitters" and has been answered by him without, however, any supporting argument pointing to his conclusion. There is no question but that the amplifier system is the best one for telephony inasmuch as the problem of modulation is very much facilitated thereby. Also it is the best system for telegraphy when a number of tubes are used in excess of two or three. But when two tubes are used for telegraphy, it seems improbable that the output of the amplifier arrangement is as good as the output of the straight oscillator arrangement.

The output of two tubes oscillating in parallel is 2P, P being the output of one tube. If the amplifier arrangement is used, one tube acts as master oscillator and one as amplifier delivering an output in the antenna. Now in order for the amplifier system to be equal to the oscillator system using two tubes for telegraphy, the output of the amplifier would have to be equal to that of the two tubes oscillating in parallel. Now one of the advantages of the amplifier system is that it permits of better control than the oscillator system, that is, the voltage applied to the amplifier grid can be controlled and adjusted over any range more easily than with the oscillator system. Thus it is possible to work the amplifier at the optimum point on its characteristic curve and so secure the maximum power available from the tube. But even with this advantage it is hardly likely that the amplifier will deliver an output equal to the output of two tubes oscillating in parallel, as Mr. Blatterman seems to suggest. At best the amplifier will deliver a somewhat higher output than an individual oscillator. On a two tube set, therefore, where telegraphy only is used, the operation of the tubes in parallel will give the greater output. Where telephony is concerned there can be no question as to the superiority of the amplifier system. Likewise with telegraphy, when the number of tubes begins to reach figures in excess of two or three, best results from an operational point of view will be obtained with the amplifier system. The controls and adjustments are more easily effected. Also the output of the amplifier system will be greater than that of the corresponding oscillator system.

Reporting the Big Scrap by Radiofone

(Continued from page 97)

It is of the "T" type and consists of four No. 14 stranded fosfor-bronze wires, 450' long with a 250' lead-in. It has a natural period of 740 meters and spreads about 250' above the ground. This antenna was energized by a current of 15 amperes furnished by the transmitter which in Radiofone circuits is considered a great deal of current to radiate in the air. The wavelength to which it was necessary for the Radiofone receiver to tune up to was 1,600 meters.

HOW THE FEAT WAS ACCOMPLISHED

The actual reporting was done in the following manner. Mr. D. Sarnoff, General Manager of the Radio Corporation of America, and Mr. J. A. White were located at the ringside in the press stand and took turns at reporting the most important features over a private telephone wire furnished for the occasion thru the courtesy of the American Telegraph and Telephone Company, leading direct to the Radio room at the Lackawanna terminal. The news was given round by round and incident by incident, and at the other end was typed directly from

Condensite celoron

Makes Good Radio Equipment Better

Insulation is the foundation of all radio. Your equipment can only be as efficient as the insulation you use in its construction. Condensite Celoron is the safest, surest and most successful answer. There are seven salient reasons why.

Condensite Celoron is high in resistivity and dielectric strength, extremely water resistant, immune to atmospheric and climatic conditions, insoluble, infusible, long-lasting and attractive. Read this Bureau of Standard test:



Wave Length Meters	Approximate Frequency Cycles per Second	Phase Difference Degrees	Dielectric Constant—K
373	804,000	2.0	4.7
1,295	231,500	1.8	4.8
3,067	97,800	1.2	4.9

We supply this remarkable material in standard size sheets, rods and tubes ready for all machining purposes—for experts and amateurs. Sold by radio equipment dealers everywhere. If your dealer cannot supply you, write us.

Diamond State Fibre Company

Bridgeport (near Philadelphia), Penna.

Branch Factory and Warehouse, Chicago
Offices in Principal Cities

In Canada, Diamond State Fibre Co.
of Canada, Ltd., Toronto



Licensed
Under the
Original
Armstrong
Patents.

Summertime Radio

NO NEED FOR YOU TO SHUT UP SHOP WHEN SUMMER COMES,
THAT IS, IF YOU OWN A

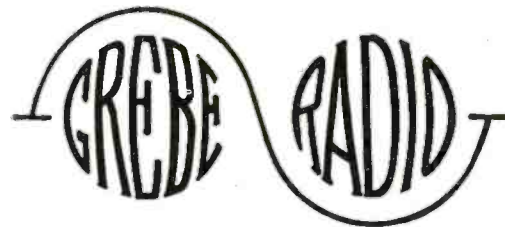

KT-1 PORTABLE

At last here's the outfit that makes Summer radio work a pleasure.

Take it out into the country and send up a few hundred feet of antennae on a Grebe Radio Kite, and surprise yourself at its range.

Find out the range of your home station.

If you live near a body of water, procure a canoe or row boat and you have a ship station that sails under power of your kite.

Then, when Winter comes again, merely replace the CR-5 Regenerative Receiver in its cabinet and use it in your station for *real results*.

See it at your Dealer's, today!

- Bunnell & Co., J. H., New York City.
- Central Radio Company Inc., Kansas City, Mo.
- Continental Radio and Electric Corp., New York.
- Detroit Electric Co., Detroit, Mich.
- Doubleday-Hill Electric Co., Pittsburgh, Pa.
- Electrical Specialty Co., Columbus, Ohio.
- Holt Electric Utilities Co., Jacksonville, Fla.
- Hurlburt Still Electrical Co., Houston, Texas.

- Kelly and Phillips, Brooklyn, N. Y.
- Klaus Radio Company, Eureka, Ill.
- Manhattan Electrical Supply Co., New York, Chicago, St. Louis.
- Leo. J. Meyberg Co., San Francisco, Cal.
- Newman-Stern Co., Cleveland, Ohio.
- F. D. Pitts Co., Inc., Boston, Mass.
- Philadelphia School of Wireless Telegraphy, Philadelphia, Pa.
- Western Radio Electric Co., Los Angeles, Cal.
- Hickson Electric Co., Inc., Rochester, N. Y.

A. H. GREBE & CO., Inc.,

72 Van Wyck Blvd., Richmond Hill, N. Y.

Quality Radio Equipment

New Grebe Portable
Radio Station Type KT-1

Ideal Vacation Outfit

Especially Adaptable and Efficient for
Boy Scouts, Campers and Tourists

Absolutely the newest and neatest combination
Transmitting and Receiving Portable Outfit on
the market. Complete with Grebe CR 5 Receiver,
Transmitter, Vacuum Tubes, Batteries and Head
Set in attractive and durable case. Weight 24 lbs.



\$175.00 Complete

Full line of Radiotron Vacuum Tubes and Access-
ories and other Highest Grade Radio Supplies.

Dealer's Special Proposition—Mail orders promptly filled

DOUBLEDAY-HILL ELECTRIC CO.

715 Twelfth St., N. W., Washington, D. C. Radio Dept.—Desk B 719-21 Liberty Ave., Pittsburgh, Pa.

PEORIA
ILLINOIS

PEORIA RADIO SALESCO....

PEORIA
ILLINOIS

127 So. Jefferson Street

"FIRST TESTED—THEN SOLD"

RETAIL DISTRIBUTORS FOR KLAUS RADIO

NOTE OUR NEW ADDRESS

We have taken over a five story building
to accommodate our increasing business

Get your name on our mailing list.

PHILADELPHIA SCHOOL OF WIRELESS TELEGRAPHY

1533 Pine Street Philadelphia, Pa.



Reg. U. S. Trademark

Labor Saving Table

(Continued from page 116)

2.5447	.8	5.6549	47.7836	.8	24.5044
2.8353	.9	5.9690	49.0167	.9	24.8186
3.1416	2.0	6.2832	50.2655	8.0	25.1327
3.4636	.1	6.5973	51.5300	.1	25.4469
3.8013	.2	6.9115	52.8102	.2	25.7611
4.1548	.3	7.2257	54.1061	.3	26.0752
4.5239	.4	7.5398	55.4177	.4	26.3894
4.9087	.5	7.8540	56.7450	.5	26.7035
5.3093	.6	8.1681	58.0880	.6	27.0177
5.7256	.7	8.4822	59.4468	.7	27.3319
6.1575	.8	8.7965	60.8212	.8	27.6460
6.6052	.9	9.1106	62.2114	.9	27.9602
7.0686	3.0	9.4248	63.6173	9.0	28.2743
7.5477	.1	9.7389	65.0389	.1	28.5885
8.0425	.2	10.0531	66.4761	.2	28.9027
8.5530	.3	10.3673	67.9291	.3	29.2168
9.0792	.4	10.6814	69.3978	.4	29.5310
9.6211	.5	10.9956	70.8822	.5	29.8451
10.1788	.6	11.3097	72.3823	.6	30.1593
10.7521	.7	11.6239	73.8981	.7	30.4734
11.3411	.8	11.9381	75.4296	.8	30.7876
11.9456	.9	12.2522	76.9769	.9	31.1018
12.5664	4.0	12.5664	78.5398	10.0	31.4159
13.2025	.1	12.8805	80.1185	.1	31.7301
13.8544	.2	13.1947	81.7128	.2	32.0442
14.5220	.3	13.5088	83.3229	.3	32.3584
15.2053	.4	13.8230	84.9487	.4	32.6726
15.9043	.5	14.1372	86.5901	.5	32.9867
16.6190	.6	14.4513	88.2473	.6	33.3009
17.3494	.7	14.7655	89.9202	.7	33.6150
18.0956	.8	15.0796	91.6088	.8	33.9292
18.8574	.9	15.3938	93.3132	.9	34.2434
19.6350	5.0	15.7080	95.0332	11.0	34.5575
20.4282	.1	16.0221	96.7689	.1	34.8717
21.2372	.2	16.3363	98.5203	.2	35.1858
22.0618	.3	16.6504	100.2875	.3	35.5000
22.9022	.4	16.9646	102.0703	.4	35.8142
23.7583	.5	17.2788	103.8693	.5	36.1283
24.6301	.6	17.5929	105.6852	.6	36.4425
25.5176	.7	17.9071	107.5182	.7	36.7566
26.4208	.8	18.2212	109.3688	.8	37.0708
27.3397	.9	18.5354	111.2202	.9	37.3850
28.2743	6.0	18.8496	113.0973	12.0	37.6991



New! NEW! New!

Bunnell MULTIPLE RHEOSTAT 28 OHMS

"Bunnell Quality"

Sample by Mail, \$3.00

Get descriptive circular
Send Stamp for Catalog 42 R.N.
We Carry High Grade Radio Goods

J. H. BUNNELL & CO.

32 Park Place New York

LEARN WIRELESS

at the largest radio school
in the Central States
Modern complete equipment
Experienced instructors. Dorm-
itory in connection. Stu-
dents may earn expenses if
necessary. Write today for
catalogue and full informa-
tion.

CENTRAL RADIO SCHOOL
316 E. 14th St. Kansas City, Mo.

PLATE BATTERIES

Always something doing with Eraco Batteries
on your plate.

Eraco No. 503 22½ volts.....\$2.00

Eraco No. 803 36 volts.....3.20

Black Fibre Panels, ¼x30x7.....3.00

Or cut to size .02½ per square inch.

ECONOMY RADIO SUPPLIES CO.,
232 Sanford Street East Orange, N. J.

the telephone and handed to the Radiofone operator in the form of bulletins. The latter immediately spoke into the regular mouthpiece shown on the Radiofone panel, so that hardly a minute was lost between the actual incident and the spoken voice in the air.

Several thousand letters have since been received by the Radio Corporation from amateurs located up to distances of 500 miles from the scene of action, remarking upon the unusually clear voice of the speaker and enthusiastically voicing their approval at the success of the experiment, for it was the first time in the history of Radio that the results of such a boxing match were broadcasted by Radio telephone.

FUTURE EVENTS

Incidentally, this initial success has spurred Radio Corporation engineers to let the apparatus remain intact at Hoboken for some time to come in order to permit experiments designed to further popularize this novel news-reporting device. In fact, it is announced that if the proposed fight between Messrs. Carpentier and Brennan takes place on Labor Day, the details of the bout and its results will likewise be reported in the same modern manner.

In the future, it is proposed to employ the Radiofone to report all events of national and international importance such as elections and big sporting events. Indeed, we are living in the age of miracles and the day is not far off when almost every home will be equipt with its own wireless telephone receiver capable of receiving the news of the day on one wave-length and the latest popular music and songs on another, simply by turning a knob in much the same manner as we operate our Victrolas. As a matter of record, many wireless amateurs thruout the country are doing this very thing now—it is only a matter of spreading the gospel of the Radiofone to the everyday man.

The Radio telephone is capable of very useful service. It has already proven its worth in many ways, and finally reporting weather conditions and agricultural facts to farmers throughout the United States, a proposition which the U. S. Government is actively pursuing.





THE RADIO MAGNAVOX

NOW USES LESS CURRENT (IN THE FIELD)
THAN A VACUUM TUBE

Averaging *Only 1 Ampere* at 6 Volts,
in the field, the Radio Magnavox will repro-
duce amplified signals or speech louder than
any other type of receiver.

The Electro-Dynamic principle has in the past
superseded the Electro-Magnetic principle in al-
most every form of electrical apparatus employed
for the transformation of electrical energy into
mechanical energy—the startling results obtained
with Magnavox Dynamic Receivers indicate that
this type is destined rapidly to supersede all other
forms of electrical sound reproducers.

THE MAGNAVOX IS A TRUE ELECTRO-DYNAMIC LOUD-SPEAKER—RE-
PRODUCES IN PROPORTION TO ITS INPUT—IT CANNOT
CHATTER NOR DISTORT.

Price \$45.00

AT YOUR DEALERS
NO BETTER VALUE EVER OFFERED
TO WIRELESS AMATEURS

THE MAGNAVOX COMPANY

OAKLAND, CAL., or 370 7th Avenue, Penn. Terminal Building, NEW YORK CITY

“INSULATE”

MOULDED COMPOSITION
ON THE MARKET 20 YEARS

ALSO
‘Hi Heet’
SYNTHETIC-PHENOL
Moulded - Compositions



100

Different Style Knobs, Binding Posts,
etc. In Stock in Quantities for
Immediate Shipment.

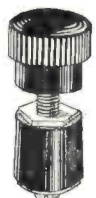

WE SELL THE TRADE ONLY. NO RETAIL ORDERS TAKEN

GENERAL INSULATE COMPANY

999 Atlantic Avenue, Brooklyn, N. Y.

Trade Mark



KEYSTONE WIRE

Wire for every Wireless Purpose

MAGNET WIRE

We are prepared to furnish best grade magnet wire on 1/4 and 1/2 lb. spools at the following revised prices:

PRICE PER 1/4 LB. SPOOL				
B&S Ga.	Single Cotton	Double Cotton	Single Silk	Enameled
No. 22	\$0.56	\$0.68	\$0.62	\$0.45
No. 24	.60	.77	.67	.47
No. 26	.65	.88	.71	.49
No. 28	.75	1.10	.85	.52
No. 30	.85	1.24	.97	.53
No. 32			1.15	.55
No. 34			1.52	.59
No. 36			1.77	.69

Price on 1/2 lb. spools double above list.

All prices are net and include cost of spool and delivery charges via Parcel Post to any Post Office address in the United States; safe delivery guaranteed.

Send for Circular 21-A giving prices on other sizes, insulations and quantities of Magnet Wire. This circular lists "WIRE FOR EVERY WIRELESS PURPOSE."

KEYSTONE WIRE COMPANY

P.O. BOX 120 SCRANTON, PA.

Canadian Radio Experimenters

SPECIAL Radio Storage Batteries

40 Ampere hour, 6 volts	\$32.00
60 Ampere hour, 6 volts	25.00
Baldwin Telephones, Type C	24.75
Brandes Telephone, Superior	12.00
THI	18.00
NHI	21.00
Murdock Telephones, 2,000 ohm	6.00
3,000 ohm	7.20
Lateral Coils to order.	
Inductances for Wireless Telephone.	
Milliammeter and Hot Wire Meters.	
Vario-Couplers and Variometers	4.25
Transmitters for Radio Purposes	3.50
LOOK LOOK LOOK	
1/4 HP 110 volt 25 cycle Menominee Motors	30.00
1/5 HP 110 volt 25 cycle Menominee Motors	25.00
1/10 HP 110 volt 25 cycle Menominee Motors	20.00

Send 5c for 30 page catalogue

J. M. PAQUIN

The Electrical Shop

787 Queen St., West, Toronto, Ont.

\$1.75 LEARNERS SETS \$1.75

With Code and Instructions



60c BUZZERS 60c

Easily tuned; silver contacts; tone adjustments located on top.

\$1.50 SENDING KEYS \$1.50

All brass, lever type, bakelite base and knob all postpaid.

AJAX ELECTRIC CO.

Palmer St. Cambridge, 38, Mass.

STANDARD RADIO EQUIPMENT

AGENTS FOR	
MURDOCK	FEDERAL TEL.
BRANDES	AMERICAN RADIO
BURGESS	AUDIO TRON
GREBE	CHICAGO RADIO LAB.
BENWOOD SPEC.	DUBLIER
DE-FOREST	TRESCO AND OTHERS

U. of I. SUPPLY STORE, Inc.
827-29-31 SOUTH WRIGHT STREET
CHAMPAIGN, ILLINOIS

When Romance Meets Up With Science

(Continued from page 130)

parently made him apprehensive.

Anita's heart sank. But almost simultaneously the blue light darted toward the train, and Anita was dazed to see Mark catch hold of the rail with one foot, then with one hand, and pull the Astral's ladder in close.

"Quick, sweetheart! Grab hold here and come with me!"

The sight of Papa Brown about to open the vestibule door gave Anita a playful courage. She WOULD like to get the best of Papa Brown.

Without hesitation, she acted as Mark directed, and together, at the bottom of the ladder, they swung clear of the train, then up and away, Mark holding her close inside his own hold, so that he formed a sort of human basket for her.

Then they merely held on tight as they soared high thru the cold night air, and the ladder was reeled in from above, lifting its human freight upward, until they were finally inside the ship itself. Then a trap door closed under them.

Safe and happy, but breathless, they sank into the warm cockpit.

Papa Brown had seen enough of the wild performance to know that he had been beaten. When he retreated toward his stateroom, he was in a cold sweat from the fear and rage he had felt at what had taken place before his very eyes.

As he was passing the Radio compartment, Speedy, trying to be solemn, handed him a Radiogram blank.

"You're a fuzzy old frump," it read, "but we love you just the same. Please forgive us."

Some 30 minutes later, Papa and Mama Brown came into the mysterious stronghold of Speedy MacReynold.

The elderly couple were moist-eyed, but, withal, jubilant.

"Can you talk to that there airship with this contraption?" asked Mr. Brown.

Speedy assured him that he could.

"Then send 'em this," said the old gentleman, and he scrawled slowly:

"Your nerve wins. Take good care of the girl, Mark."

It was signed "Papa Brown," which meant to Mark and Anita, flying westward in the Astral, the welcome end of a hard won battle.

Who's Who in Radio

(Continued from page 113)

Ferrié was the Research Laboratory installed in Paris and in which were designed all the modern Radio apparatus which were needed during the war.

General Ferrié is Doctor Honoris Causa of Oxford University, England. He is also Laureate of the French Academy of Sciences. He was awarded, in 1904, the Kastner Boursault prize and in 1912 the Wilde prize. Among the 17 French and foreign decorations awarded to him may be mentioned the American Army and Navy Distinguished Service medals.

The Radio-Controlled Ship "Iowa"

(Continued from page 95)

valves of the main engines, the automatic time clock, the commutator and the electrical control for the steering gear (with the exception of the gyro-compass itself) were furnished by the General Electric Company.

SPECIAL PROCESS PANELS OF NATURAL OAK OR BLACK FINISH.

Treated with a special process made by us. Will not Warp or Shrink and is not affected by Temperature changes Waterproof and possesses High Dielectric properties. Easily machined and will not Crack or BREAK.

Looks much better on your set than Formica or Bakelite and costs considerable Less.

We are prepared to ship promptly and without delay the following standard sizes.

6 x 8 1/4" thick...\$35	6 x 12 x 1/4" thick \$.95
6 x 6 1/4" thick... .50	9 x 12 x 1/4" thick 1.10
6 x 8 1/4" thick... .60	12 x 12 x 1/4" thick 1.50
6 x 9 1/4" thick... .70	12 x 18 x 1/4" thick 2.00
6 x 10 1/4" thick... .80	18 x 22 x 1/4" thick 3.00
Strips 3 1/2 x 6; 3 1/2 x 8; 3 1/2 x 10. \$40 each.	
3 1/2 x 12; 3 1/2 x 18. \$60 each. All 1/4" thick.	

SPECIFY WHAT FINISH. NATURAL OAK OR BLACK.

Add Postage for 1 lb. for above Panels

We will be pleased to quote prices on these panels cut to a different size on receipt of your specifications.

We also carry Tenso C.W. Inductance, Unmounted, \$4.50.

In purchasing your Panels and Radio equipment of us of which we have all standard makes and our prices are the same as advertised we will mount it on any of the above panels you purchase according to your specifications FREE OF CHARGE.

Progressive dealers stock these panels.

TENSO MFG. CO. Marshall, Minn.

Specializing in the construction of Radio sets to your specifications.

SPECIAL PRICE REDUCTIONS

Paragon Control Panel with Radiotron Tube	\$10.50
Audiotron Tube, two filaments	5.50
Radiotron Detector Tube with a combination Grid Leak Condenser	5.00
Murdock 2000 Ohm Wireless Head Sets	4.00
Murdock 3000 Ohm Wireless Head Sets	5.00
Rubber Cap Binding Posts, per doz.	1.00
Ace 22.5 Volt B Battery	.98
Ace 22.5 Volt B Battery, Large Type	1.75
No. 766 Eveready Large B Battery	2.75
Chelsea Dial and Knob with Paragon Rheostat	\$2.50

Marko Storage Batteries

6 Volt 20 to 40 Amp.	\$10.85
6 Volt 40 to 60 Amp., Ford Type	15.00
6 Volt 40 to 60 Amp., Large Type	16.00
6 Volt 60 to 80 Amp., Ford Type	18.50
6 Volt 60 to 80 Amp., Large Type	\$20.00

Prompt Attention Given to Mail Orders. The Above Prices are F.O.B. New York.

Hygrade Electrical Novelty Co.
41 West 125th St. New York

CHALLENGE "A" BATTERY

(JOHNSON PROCESS)



Size of each cell 8 3/4 high x 6 1/2 wide x 2 1/4 long over all.

NONE BETTER

Price in sets of three cells (6 VOLTS) \$11.48

Challenge Battery Co., 16 W. Illinois St. CHICAGO, ILL.

Do You Know Doctor Mu?

AMATEURS

Our stock of CW and Spark Radio apparatus is complete. Send us your order and it will be filled same day it is received.

T & H RADIO CO.
ANTHONY, KANSAS

Using An Inefficient Condenser is Like Carrying Water in a Sieve



The same judgement used in the purchase of radio equipment that you use unconsciously in everyday affairs will invariably lead you to select COTOCO condensers. Users are unanimous in proclaiming them "the best."

This condenser used in conjunction with our inductance units will enable you to build a set that you will be proud to own.

If your dealer cannot supply you with our products, advise us, and send us his name.

COTO-COIL CO., 87 Willard Ave., Providence, R. I.

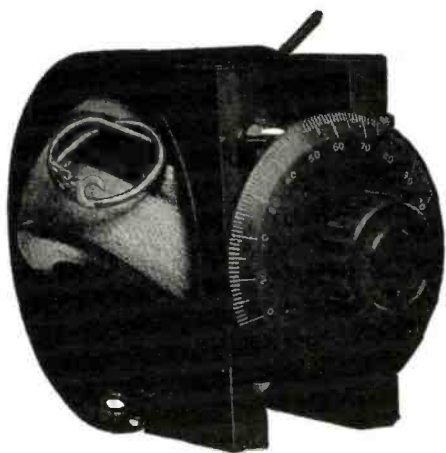

The Variometer

The now famous Z. R. V. Variometer has met with a tremendous sale to thousands of discriminating purchasers who know the quality of Clapp-Eastham products.

Complete with knob and dial . . . \$6.50
 Complete without knob & dial 5.75
 Variocoupler to match, with knob and dial 7.50

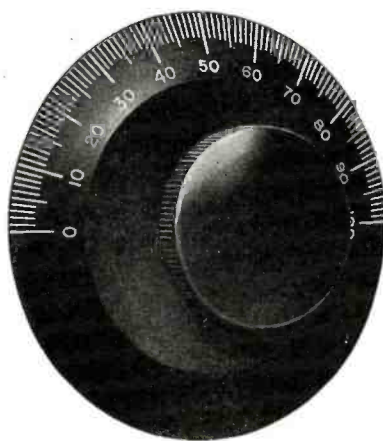

The Dial

This 3" knob and dial is our own product, heavy brass dial, black oxidized finish, composition knob 1 3/8" diameter. Supplied for 3/8" shaft only. This dial can not chip or warp and will run true. Its beauty is in keeping with the best products of the instrument maker.

Price, Dial & Knob F800H complete \$.75
 No. 19 instrument switch to match above 1.00

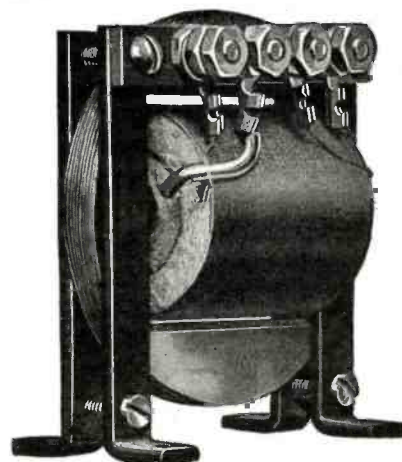

The Amplifying Coil

Our amplifying coils are distinctly different in design and their remarkable power of amplification with the tubes at present on the market can be testified to by several thousand satisfied users. You need not experiment with untried products unless you want to.

Type Q. O. Amplifying coil as illustrated \$4.00

Complete Catalogs Sent for 6c Stamps

Patronize your local dealer: If he won't supply our material your order will receive immediate factory attention.

CLAPP-EASTHAM COMPANY

120 Main Street

Cambridge, Massachusetts

HEADQUARTERS FOR RADIOTRON TUBES. ALL TYPES IN STOCK

ACME AMPLIFYING TRANSFORMER

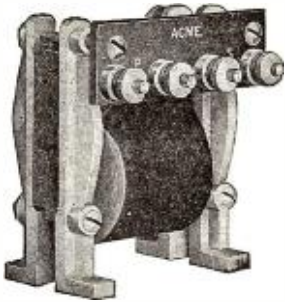

THE PROPER ratio of turns and impedance, exactly suited to the new VTs is an important feature of the transformer shown above.

Our coils are of the paper wound type, thoroughly impregnated. They are provided with strong flexible leads, and contain no soldering flux of any description.

Get an ACME Amplifying Transformer and your transformer needs are cared for *perpetually*.

Electrically, mechanically, and artistically—from every viewpoint an Acme is as good a transformer as can be made. And every instrument is backed by the ACME guarantee.

ACME APPARATUS CO.
188 Massachusetts Ave.
Cambridge, 39, Mass.

*Transformer and radio
engineers and manufacturers*

AMATEURS!

Use the apparatus
8 Z R

uses. The apparatus that makes possible transcontinental transmission.

*Write for a bulletin
describing this apparatus*

**The American Radio Sales and
Service Company**

Great American Bldg. Mansfield, Ohio
Testing Station 8 Z R

WINO BATTERIES

For Use With Radio Apparatus

BUY DIRECT FROM MANUFACTURER

6 Volt—40 ampere hour.....\$13.40
6 Volt—60 ampere hour.....15.58
6 Volt—80 ampere hour.....19.85
War Tax included—Express prepaid.

Fully Guaranteed.

*Send Postoffice or Express Money
Order.*

The Wino Manufacturing Co.
717 Sycamore St. Cincinnati, Ohio

Broadcasting Radio Market News by the Missouri State Board of Agriculture

(Continued from page 105)

intensive and practical manner. The installation of many Radio outfits to connect the various counties with market news headquarters of the State Marketing Bureau will undoubtedly follow in the wake of this means of demonstrating the practicability of connecting the smaller towns and even the farm homes with the outside world by Radiofone.

No let-up in this demonstration work is anticipated by those in charge of the work in Missouri. Connections will be made from time to time between the State Marketing Bureau offices at Jefferson City, and various meetings of farmers and farm organizations, such as Farmers' Week held at Columbia annually, various agricultural conventions held in St. Louis and Kansas City, meetings of Farm Bureaus, Farm Clubs, Granges and Unions.

Both manufacturers and jobbers of Radio equipment are taking a keen and active interest in the Missouri program and will assist it by very substantial and effective means. It offers the first opportunity in the history of Radio for the promoters of the science of wireless communication to assist in a big program of showing the people of any State the value of the wireless telephone and telegraf.

Led by the State Marketing Bureau within the borders of their own State, Missourians, the "show you" folks, are going to be "shown" one of the most remarkable advantages offered by modern science. Other States will undoubtedly follow the example set by that great agricultural State.

Arrangements will be made to invite President Harding to speak from Washington to the Missouri State Fair folks during the two weeks' fair. Governor Arthur M. Hyde also will address the Missouri crowds by Radiofone several times during the Centennial State Fair. Daily market news will be distributed thru the crowds, and Radio concerts will be given during the period of the great Centennial State Fair.

Construction of a 1-KW Arc Converter

(Continued from page 103)

sition, where it may be altered for proper radiation. The moving part is connected to a terminal block thru a flexible three-ply bronze friction contact. The motor-driven worm gear rotates a pinion mounted in the brass standards. The large spur gear engages the pinion.

Two resistance units are included in the circuit while the arc is being started. This is done to prevent overload when the arc is struck. They may be cut from the circuit by closing a single pole switch shunting them after the arc resistance becomes effective. Opening the line switch also opens the starting switch thru an interlocking device, including the resistances automatically for the next operation.

To operate the arc: main line switch is closed. This leaves the starting resistances in circuit, and also starts the rotating motor. The arc length is then adjusted to about one thirty-second of an inch, and the striking knob is then pushed inward and quickly released. Alcohol is then turned on and allowed to drop quite rapidly for a few seconds,—then decreased to about 20 drops per minute. The starting switch is then closed and the arc length again adjusted for the maximum output. The arc length is about three-sixteenths of an inch while operating.

10c CHARGES YOUR BATTERY AT HOME WITH AN F-F BATTERY BOOSTER

and your station will never be closed because of a discharged battery. Is it not gratifying to feel that your filament battery will always be ready when you want it and that you will never have to give up in disgust when working a distant station?



F-F Battery Boosters are automatic and operate unattended. Screw plug in lamp socket, snap clips on battery terminals and see the gravity come up.

The ammeter shows you just the amount of current flowing. The full wave of current is rectified thru adjustable carbon electrodes which maintain a constant efficiency and last for thousands of hours. Everything complete in one compact, self-contained unit.

The F-F Battery Booster is a Magnetic Rectifier for 105-125 Volt 60 Cycle Alternating Current.
Bantam Type 6 Charges 6 Volt Battery at 8 amperes. \$15
Type 16 charges 6 Volt Battery at 8 amperes.... \$24
Type 168 charges 6 Volt Battery at 12 amperes... \$32

Shipping Weights 10, 12 and 15 lbs.
Also Boosters for 12 Volt Batteries at same prices. Order from your dealer or Send Check for prompt Express Shipment. If via Parcel Post have remittance include Postage and Insurance Charges. Will also ship C.O.D. Also F-F Battery Boosters for charging batteries from Farm Lighting Plants, Direct Current Circuits and Direct Current Generators.

For GROUP CHARGING use the Full Wave Automatic F-F ROTARY RECTIFIER of 100 Volt, 36 cell capacity.

Order now or write today for Free Descriptive Bulletin No. 32 or ROTARY Bulletin No. 32A

THE FRANCE MFG. CO. Offices & Works:
Cleveland, Ohio, U.S.A.
Canadian Rep: Battery Service & Sales Co. Hamilton, Ontario

NEW ORLEANS RADIO

**APPARATUS
and SUPPLIES**

ROSE RADIO SUPPLY

604 Gravier St., New Orleans, La.

Send 10c for Latest Catalog



The Midgal "FIVE-IN-ONE" Slide Rule is a combination Mannheim, Log-Log, Add and Subtract, Polyphase and Binary Slide Rule. It will instantly add, subtract, multiply and divide any combination involving whole numbers, fractions, decimals and mixed numbers. Gives every possible root and power of every quantity. The graduations are printed on metal coated with white celluloid and are grease and waterproof. While it is the most versatile calculator ever invented, its operation is simple and easily understood. Diameter 4"

Price with 16-page Instruction Book, \$1.50. Leatherette carrying case 50c extra. Catalog free. Your money back if you are not satisfied. **Gilson Slide Rule Co., Niles, Mich**

Do You Know
Doctor Mu?

CONNECTICUT RADIO EQUIPMENT

Variable Condensers, Transmitters, Head Bands, Panel Switches, Etc.

Connecticut Tel. & Elec. Co., Meriden, Conn.

You can be quickly cured, if you

STAMMER

Send 10 cents for 288-page book on Stammering and Stuttering, "Its Cause and Cure." It tells how I cured myself after stammering 20 yrs. B. N. Bogue, 873 Bogue Bldg., 1147 N. III. St., Indianapolis.

If it's a Radiophone—It's a deForest Invention

De Forest REG. U.S. PAT. OFF. RADIOPHONE

Be Sure it's the deForest Design of Wireless

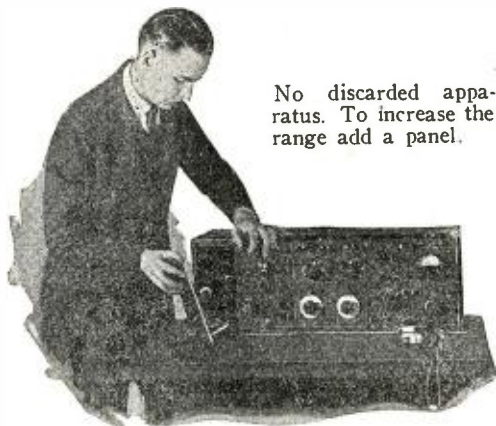

No discarded apparatus. To increase the range add a panel.

FOUR PANEL STATION

- Complete set of four units mounted vertically.
- (1) Complete radio "Midget" transmitter. Phone sending range 30 miles (OT-3).
 - (2) Complete short wave tuner, 150 to 600 meters (MT-100).
 - (3) Complete audion control, especially for gaseous tubes (MP-100).
 - (4) Complete one-step amplifier (MP-200).
 - (5) Any additional step of amplification may be added.

It is better to be sure first than sorry afterwards.

The deForest "Interpanel" system is for amateur and commercial CW telegraph and telephone stations. It is the one design absolutely necessary to get full success of CW transmission, made possible by Dr. deForest's invention of the audion.

Each panel is only 9 inches high.

Each panel mounts a *complete* apparatus.

Each panel gives the exact space best suited to all parts.

Panels may be combined in any relative positions.

Get the "Interpanel Idea"
Send for Catalogue 87

DeForest Radio Tel. & Tel. Co., 1415 Sedgwick Ave., New York City

Inventors, Licensors and Manufacturers of Highest Grade Radio Apparatus

Sole Western Distributors, **PACIFIC RADIO SUPPLIES CO., 638 Mission St., San Francisco, Cal.**

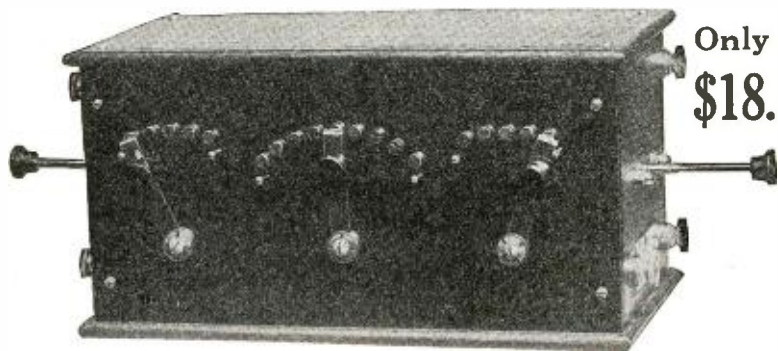

Only
\$18.

Are You Enjoying the Phone Concerts? This Tuner Gets the Radio Phone Stations Fine

It is also very selective and efficient for receiving all 200-600 meter stations. There are switches for varying the wave length of all circuits. It has advantages over many other tuners. For instance, it has a movable secondary and a movable tickler coil which may be placed within, or either side of the primary for tuning in loud clear signals and tuning out unwanted stations. It is enclosed in a handsome quartered oak cabinet with hard rubber panel.

"Mr. Thomas Comstock, Newark, N. Y., says: "Your Short Wave Tuner is a peach. I get phone stations great, and am able to read the amateur stations with the phones off my head."

"Mr. Joseph Briggs, Cortland, N. Y., writes: "I want to thank you for the prompt service in shipping Short Wave Tuner—only forty hours from the time I mailed order until I receive the tuner."

\$25.00 to \$40.00

Long Wave Tuner Now Furnished in Two Sizes 600 to 2,500 and 2,500 to 20,000 Meters

We are now prepared to furnish our Long Wave Tuner Cabinet with inductances which respond to wave lengths from 600 to 2,500 meters. Several of these new tuners were used to receive the Dempsey-Carpentier fight and every one reported fine signals without interference.

- | | |
|---|---------|
| Price 600-2,500 meter tuner in quartered oak cabinet..... | \$25.00 |
| Price with hard rubber panel | 28.50 |
| Price 2,500 to 20,000 meter tuner in quartered oak cabinet..... | 34.50 |
| Price with hard rubber panel | 40.00 |

Mr. Albert Vanderbilt, Newark, N. Y., says: "By using a Baldwin loud speaker with your Long Wave Tuner I have heard W.S.O. 3 houses away, with only one bulb."

Send a 2-cent stamp for bulletins

COLBY'S TELEGRAPH SCHOOL, Auburn, N. Y.

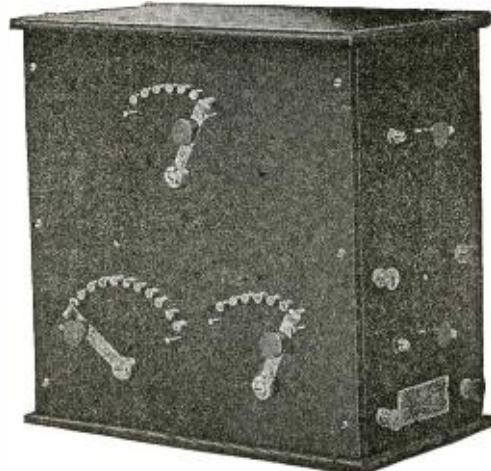

ACE Efficient Equipment at a Reasonable Price

ACE Radio Apparatus will give your station that clean-cut, dignified and business-like appearance so characteristic of the modern Radio Amateur's Installation. We offer below several suggestions:

- Ace Type AVA Variometer Tuner..... \$32.00
- Ace Type AVB Variometer Tuner 45.00
- Ace Type ATC Audion Control Cabinet..... 12.00
- Ace Type A-2 Two Step Amplifier Cabinet... 40.00

We also carry in stock a complete line of high grade, reliable radio accessories.

Send 3c in stamps for Bulletin No. 102.
Mail orders will receive our prompt attention.

Licensed under Arm-
strong Patent No.
1,113,149.

SEE OUR DISPLAY AT THE A. R. R. L. NATIONAL CONVENTION, AT CHICAGO, AUGUST 30th TO SEPTEMBER 3rd.

THE PRECISION EQUIPMENT CO.
2437-2439 Gilbert Avenue Cincinnati, Ohio

"YOU MAY PAY MORE BUT YOU CAN'T BUY BETTER"
MEMBER A. R. R. L. RADIO CALL 8 X B

Dealers and Amateurs have you our proposition?

What is more unpleasant and aggravating than an ill-fitting Battery? Make up your mind once and for all, you will have a battery that will satisfy you and your followers, a battery that does not corrode before the time expires, a battery that has proven to outlast any other make on market. Make up your mind, that this time you will buy a battery that follows the lines of your outfit, that from the very day you connect your wires to the battery it will increase your service and stand up to its test.

SAB-IS-CO batteries combines the three features, that you have been looking for, Battery, Guarantee and Price. Our variable battery observe so closely, the posts that economize and give you the full value for the money.

For the SAB-IS-CO battery, whether variable or plain, large or small, are made of the very best and highest grade material that science can produce. Select your styles and order them by number as follows:

- No. 923 Small, plain \$1.25 each
- No. 923 Small, variable 2.00 each
- No. 925 Large, variable 3.50 each
- No. 925 Large, plain 2.10 each

Dealers have you our proposition—send for your discounts, Amateurs, if you cannot obtain a SAB-IS-CO battery from your dealer, write direct to us for your discounts, and we will send you free of parcel post charge. Your money will be refunded if found not satisfactory. Mention your dealer's name when ordering.

Watch for our advertisement in the August issue.

J. H. SABINSKY & CO.
640 Broadway, New York City

A New Invention

The Parkin .001 mf Variable Condenser (pat. applied for) fills the long felt want for a rugged, low priced, balanced variable condenser for panel mounting. No plates to bend and short circuit. Cannot get out of order. Has very low minimum capacity. Easily mounted, only one small hole being necessary in the panel. Guarantee: All Parkin Condensers are sold subject to return within five days if not fully satisfactory.

- No. 50 .001 mf Unit alone, may be mounted on any shaft, postpaid \$1.50
- No. 51 .001 mf Unit with knob, pointer, etc., as shown, postpaid 2.00
- No. 52 .001 mf Unit with knob, etc., and 3-inch black dial, postpaid 2.50

Write for full description of this new invention
Ask for Catalog No. 5 Dealers: Write for discounts

PARKIN MFG. CO., San Rafael, Calif.

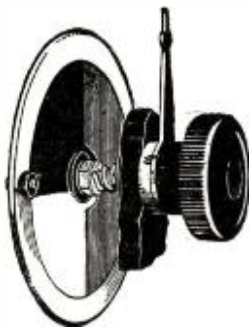

READ the CLASSIFIED ADVERTISEMENTS on PAGES 172-174. YOU'LL FIND MANY GOOD THINGS THERE

A peculiar scream is produced within the chamber while the arc is operating; so that one quickly learns the quality of oscillation being produced by this characteristic sound within the chamber.

An explosion will generally occur after the arc has remained inoperative for a half hour, but seldom takes place after the initial start.

The output of the arc varies considerably with the wave-length and form of circuit. It is difficult to deliver much energy on moderate wave-lengths; but the output will increase somewhat with lower frequencies. With a maximum input of sixteen hundred watts input, the arc delivers an average of three amperes in a closed circuit, and 1 1/2 amperes directly into the aerial circuit. The averages here given cover various tunes and values of resistance effective with them.

Radio in a Country Town

(Continued from page 98)

ter. He will deliver the goods, I know, for he has been building a troop with quiet, efficient persistence during the past five years. The operator is found also. He is a veteran of the world war, still suffering from foggy, terrifying nights among the submarines and mines in foreign waters, but he is so interested in boys and in radio that he has offered his apparatus and his time. He will pick up the broadcasts and relay them to the boys at a speed that they can copy. By gradually increasing the speed from week to week he can make himself a sort of professor in a code school, finally graduating some real speed artists.

I pointed out to these gentlemen that Canton has the opportunity of being the first country town in America to make full use of the information which the Government is putting into the air for the benefit of all every day. So far as I know, no town at present is receiving the full service and making use of it. The first town that does this will go down in history.

So I have prepared the ground and sowed the seed. What will come of it? That depends upon Canton and upon your radio manufacturers and dealers who read this. The development of interest in radio is my job, but the commercial exploitation of that interest is not.

I hope and expect that Canton will establish and maintain a radio station such as I proposed, and her public-spirited Scoutmaster and veteran operator assumed responsibility for. Beyond a doubt there will soon be many homemade receiving sets constructed. The boys were sending for catalogs and mailing orders before I had been in town a week.

But the system will not develop of its own accord. The Scoutmaster works long hours in the postoffice and he has to promote many Boy Scout activities besides radio. The operator is in charge of a railway signal tower from 11 P. M. to 7 A. M. He has to sleep some time during the day. Who is going to keep an eye on Canton and give the friendly boost now and then that will make it an expanding spot on the radio map?

The man who passes up this small town proposition as something which can be brot into line, or left out of the consideration without being felt in the business, is as blind as a week-old kitten. Canton, it is true, has but 2,500 of the hundred and ten million inhabitants of the United States who know little or nothing about radio, but listen!

As a kid I saw the building, stock and tools of Gleckner, the village harness maker, go up in smoke. Today he and his boys have a factory that it took me half a day to inspect, right there in the old home town. Swayze, the paper box man, started as a country job printer on \$50, borrowed

use A-P tubes for efficiency

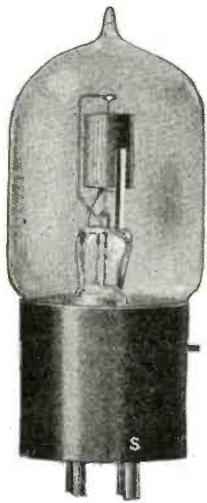

**THE A-P VT
AMPLIFIER-
OSCILLATOR**

—the amplifier used
by the U. S. Navy.
“Use the tube the
Navy uses.” Price \$7.



**THE A-P
ELECTRON
RELAY**

—the most sensitive
detector of spark sig-
nals known to the
radio art. Price \$6.

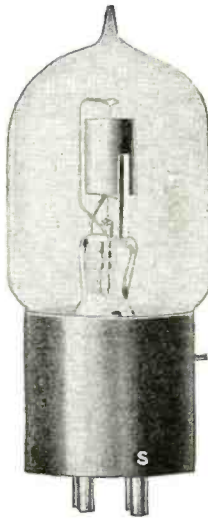

**THE A-P
TRANSMITTER
TUBE**

—an efficient un-
damped wave trans-
mitter for use in radio
telephony. Price \$7.50.

A-P Tubes are licensed by the Radio Corporation of America under the DeForest Audion and Fleming patents for amateur and experimental use in Radio communication.

Order from your dealer or write direct to

The Atlantic Radio Supplies Co., 8 Kirk Place, Newark, New Jersey
The Pacific Radio Supplies Co., 638 Mission St., San Francisco, Cal.

Distributors for Moorhead Laboratories, Inc.

**“the best I
ever tried”**

“The last vacuum tube you gave me I find that it works the best I ever tried, it also oscillates fine, and sure can hear C.W. and spark stations loud and clear. It uses less filament current than any other tube I tried.”—Signed Stephen F. Pitoniak, 12 Valley Rd., Albion Pl., April 25, 1921.

Use A.P. Tubes and you will be equally enthusiastic. Use A.P. Tubes for efficiency, use A.P. Tubes for sure results, use A.P. Tubes for better results. There is an A.P. Tube for every purpose. Use **only** A.P. Tubes.

And for the best book on Radio, ask your dealer for “Elements of Radioteleg-raphy,” by Lieut. Ellery W. Stone, U. S. N.

P A R A G O N

MEANS

“A PERFECT MODEL OF EXCELLENCE”

AND IT IS FOUND ONLY ON

RHEOSTATS
RECEIVERS
V. T. CONTROLS

CONDENSERS
VARIOMETERS
DIALS

DETECTORS
KNOBS
SOCKETS

SWITCHES
AND OTHER
SPECIALTIES

Manufactured by

ADAMS-MORGAN CO.

No. 70 Paragon V. T. Control

A compact control panel consisting of a standard socket, rheostat, grid condenser, grid leak and nine binding posts mounted on a moulded condensite panel. Polished nickel metal parts. A high-grade inexpensive instrument that will do as good work as the highest priced cabinet.

Price - - - \$6.00

No. 25 Paragon Rheostat

For either panel or table mounting. Moulded condensite base. Resistance six ohms. Smooth operation. Capacity 1½ amperes. The highest grade rheostat on the market.

Price - - - \$1.75

MOST ENTERPRISING DEALERS CARRY PARAGON PRODUCTS AS REGULAR STOCK.

Illustrated Bulletins will be mailed upon receipt of a two cent stamp. Send us your dealers name.

ADAMS-MORGAN CO.

UPPER MONTCLAIR

NEW JERSEY

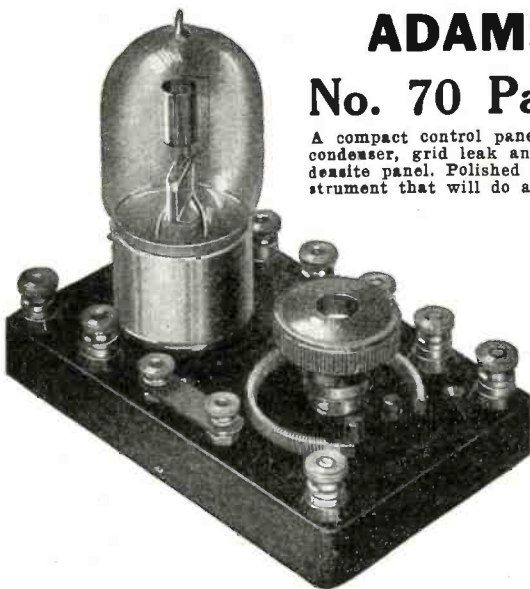

RADIO
KLAUS
D I O

RADIOTRONS

and

CW ACCESSORIES

We carry a full line of CW equipment. Circuits and instructions furnished free to our patrons. Immediate deliveries. Safe arrival guaranteed.

Send 8c for our Bulletins

KLAUS RADIO CO.
Eureka, Ill.

Canadian Amateurs

ATTENTION

It will save you \$\$\$\$ to keep in touch with us.
We give you **QUALITY, SERVICE,** and a **SQUARE DEAL.**

Brown's Famous Receivers

used by, The Admiralty, Air Force, Foreign and Colonial Armies and Navies. Tests lately made show an efficiency of three times that of any other telephonic head gear.

4000 Ohm	\$19.25
8000 Ohm	20.50

Shipping weight 2 lbs.
Send .05c for our list

THE VIMY SUPPLY CO.
567 College Street TORONTO, ONT.

QUALITY SERVICE ACCURACY

Do you know who we are? If you don't, let our catalog introduce us. It lists and illustrates the only "QSA" line of Radio Equipment on the market. We both lose money if you haven't our catalog.

Send 10 cents for it TODAY and you will learn why.

INDEPENDENT RADIO SUPPLY CO.
3716 W. Douglas Blvd. CHICAGO, ILL.
"Better Results With Less Effort"

Do You Know Doctor Mu?

capital. When he moved to larger quarters he could not pay the rent due on the ones he moved out of. Last month among other orders he had one for thirty million cartons, for which he will receive over \$100,000 much of which will be disbursed right there in Canton. Marble, who started making coat hangers on a bench in a back lot shack, now keeps two tractors busy hauling huge trailer loads of his product to the freight station. On his farm just outside the boro he and his wife have developed a fruit-growing and preserving plant, which is making agricultural history. Louis McFadden, who came off the farm at sixteen to be office boy in the bank, was cashier at twenty-two, president of the Pennsylvania State Bankers' Association a few years later and then Representative in Congress; now he is chairman of the Committee on Banking and Finance in the United States House of Representatives.

Do these facts mean anything to you? Could a man who has built a million dollar business out of nothing be of any use to you if he went around the country bragging about how his kids were keeping the village up-to-date with their wireless station? Would the country banker in a commanding position in the United States House of Representatives be helpful in radio legislation, if thru a successful demonstration back home he could be led to install radio-phones to handle his daily communications between Washington and Canton? Remember as you answer these questions that there are 26 Cantons in the United States and 35,000 other good towns—all ripe for radio.

Will they spend money? Man, they give it away when someone gets them organized and pulling together. I sat in at a concert in Canton given by an orchestra from an orphan asylum. So many people came that the poor kids had to fiddle their way thru two whole programs, for when they played the opening number, there were as many outside as there were inside. It was a free concert, but the youngsters went home with a bag containing \$500 in voluntary contributions. The church where the concert was given is a perfectly good church, but the people have just given \$35,000 to tear it down and build a bigger one. Get people like that together and let them hear a sermon, hymns and anthems by radiofone some Sabbath when the preacher is away at a Conference, and will they kick about contributing to put in a good station for the town?

The country high school meets more than the usual number of problems because its pupils have too few contacts to put big meaning into the facts of geography, chemistry, physics and languages. Would it be difficult to interest the principal and school board in radio if you showed them how every step in a boy's progress in radio coordinates with the curriculum, from the designing of the base for his tuning coil to the reception of messages from lands which he may never see except on maps?

The set with which I kept a procession of visitors wearing out my mother's parlor carpet refused to bring in any spark station distinctly except NAA. That and the big arc stations were all I had to offer. I could not hear a single radiofone station, not even KDKA. Imagine what an impression could be made with two steps of amplification and a loud speaker.

It would do no good to merely go in and sell Canton a lot of radio apparatus. A business could be built there, but not by stopping with the securing of orders. According to the wisdom with which the situation is handled, radio there may come to be known as a fad that boys squander money on, as an interesting feature for an occasional exhibition or as a necessity like the railroad and the water works. Within 30 days, the farmers can be receiving market reports which will put them on an equal footing with the produce buyers; the week-

RADIO SUPPLIES 4th DISTRICT

We have a complete line of radio apparatus of standard makes, Acme, Amrad, Chelsea, Clapp-Eastham, Eveready, Federal, General Radio, Murdock, and Radio Corporation of America.

FORMICA PANELS

6 x 12 x 3/16 in.....	\$1.35
6 x 18 x 3/16 in.....	2.00
9 x 12 x 3/16 in.....	2.00
12 x 18 x 3/16 in.....	3.85

RADIOTRON TUBES

UV-200 Detector.....	\$5.00
UV-201 Amplifier	6.50
UV-202 5 Watt transmitting	8.00
UV-203 50 Watt transmitting	30.00
UV-712 Amplifying Trans-	
former	7.00
PR-536 A. Bat Potentiometer.	2.00
677B Battery 22½ V. 5 taps..	3.00

Write for complete price list of Material Carried in Stock.

CARTER ELECTRIC CO. RADIO DEPT.
63 Peachtree St. Atlanta, Ga.

"Praco Cabinets Lead Again"

We have especially designed a Praco Cabinet for the new Remler Detector Panel.

Quality—The same high-grade materials and workmanship characteristic in all Praco apparatus.

Finish—Same as our standard Cabinets, stained, filled, shellacked, varnished two coats, hand rubbed.

Wood—Genuine African Mahogany, ¾ inch thick.

Size—The exact size for a Remler Detector Panel—just slide panel into Cabinet.

Price—Within the reach of all—\$4.00 postpaid.

We would like you to see this little cabinet, may we send you one today? Don't send any money; just pay the postman when it arrives. Your money back if not satisfied.

We carry the Remler Detector Panel in stock, and will be glad to mount same in one of our Cabinets, free of charge and send you the complete outfit, postpaid, for \$12.00.

If you don't have one of our Cabinet Catalogs—write us.



PENN RADIO APPARATUS CO., Inc.
Dept. RCI Reading, Pa.

THE VICTOR

TYPE 2 V. T. SOCKET

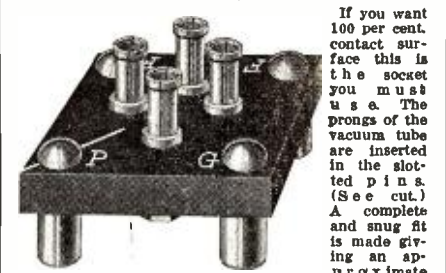

If you want 100 per cent. contact surface this is the socket to use. The prongs of the vacuum tube are inserted in the slotted pins. (See cut.) A complete and snug fit is made giving an approximate conducting surface of ¾" by ¾". Compare with others. Pins of bronze alloy selected for everlasting tension. Impossible to burn out your tube. Filament and plate leads fused. Lettered in white F-F-G-P. White Guide line for insertion of tube. Bakelite base, Nickel plated standards and screws. Pins natural finish. If you want 100 per cent efficiency from your receiving set and your 5 watt C.W., this socket will give it to you. Use this socket and forget about that microphonic tone, heating effect and all vacuum tube troubles. By mail postpaid 75 cents.

V. H. LAUGHTER
P. O. Box 78 Memphis, Tenn.

PLUGS

Cut from solid stock, not moulded, Nickeled inserts forced in. Can be used for repairing old or making new mountings.

65c

A. K. LAING, RADIO SUPPLIES PELHAM MANOR NEW YORK





The Last Word in "B" Batteries

Introducing the
New Ace 627—45 Volt Variable "B" Battery at \$3.50

Made of the same high grade material and workmanship as all our Ace types. This Battery will absolutely fulfill any B Battery requirements. The special size cell construction guarantees from 75 to 100% more service than any small size "B" Battery. Thirty voltage readings from 1 1/2 to 45 volts obtained. Size 5 3/4 x 4 3/4 x 2 3/4. Weight 3 1/2 lbs.

Another important feature is the shelf-life depreciation, which is guaranteed against more than 10% in 9 months.

For other type "B" Batteries and Dealers, see our ad on page 134

44 Court Street, Brooklyn, N. Y. **ACE BATTERY MFG. CORP.,** (Phone Main 8379)

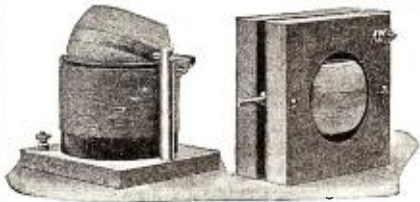

Variometers Couplers \$3.75 each

These instruments embody finest workmanship and best materials, all wooden parts genuine mahogany, coupler primary wound on formica tubing. Metal parts of brass. Wound for maximum results on short wave work. Money back if they fail. With Chelsea Dial \$1 extra.

Send for Bulletin Describing Unwired Regenerators

FREDERICK WINKLER, JR.
304 Columbus Ave., New York City, N. Y.

3000 Ohms \$8 POST-PAID



"RED HEADS"

The Accepted Standard in Radio Receivers.
At the new price of \$8.00 (formerly \$12.50) "Red Heads" are unquestionably the best wireless phone value in the world. Increased production, decreased costs and a sincere desire to promote lower prices prompt this remarkable saving.

SPECIFICATIONS: Aluminum back type with genuine bakelite ear caps, government type head band, extra fine 6 ft. cord with strain loops. Each receiver 1500 ohms (3000 ohms per pair). Sold on a money back guarantee basis and shipped prepaid anywhere on receipt of price. Dealers: Write for complete information.

THE NEWMAN-STERN CO.
Newman-Stern Bldg., Cleveland, Ohio

ly paper can be posting the Navy press daily; the jewelers can be checking up their time at noon and 10 P. M.; the constable can be picking up cars stolen in New York and reported in the police broadcasts; the Boy Scouts can be doing the most useful service of their lives in distributing the information to those who want it; a hundred boys can be acquiring in spare time a profession which means travel, education and financial competence; leaders can be organizing local contests and tournaments which will add spice to the radio activities; Canton can be in touch with her neighboring villages and with the world.

From such a start she can proceed to embellish and enliven her system with radio concerts, bringing in the voices of high-priced artists who visit only the larger cities; with radio dances, taking her choice of a dozen orchestras; with lectures brot from afar. Thru organization she and thousands of other towns could secure connection with almost any stage, platform or pulpit within a thousand miles, and even be address by President Harding himself on great occasions.

She will need only a little encouragement, an occasional visit from a man who knows, the efficient service of radio dealers in Elmira and Williamsport, the nearest cities, and of larger houses at a greater distance. Her library and school will need to be supplied with magazines and books on radio. When things refuse to work, some interested person will need to lend a hand without making a "bugbear" of upkeep.

Chautauquas which operate in small towns will have to be informed as to the value of popular lectures and demonstrations concerning radio. I wrote to one of the largest organizations of this kind about it, and I doubt if they even looked in the dictionary to see what it meant. In their reply they carefully avoided any mention of it. "Farmers' Weeks" and Grange conventions

THE THIRD EDITION OF THE CONSOLIDATED RADIO CALL BOOK

Very Greatly Enlarged — 192 Pages 32 pages more than 2nd edition, better paper, stiff covers, etc.

READ WHAT SOME OF THE PURCHASERS SAY

S.S. Newton April 26, 1921.
Claremont, Va.

Gentlemen:—Rec'd your new call book yesterday. It is fine. Many thanks. Sincerely,
T. T. Scholey, Rdo, Elec.

Mattituck, N. Y.
Dear Sirs:—Received my call book to-day and it is well worth the waiting I did for it. Thanks.
Yours truly, Louis C. Gilderselevs.
April 28, 1921.

Buckhannon, W. Va., April 25, 1921.
Gentlemen:—I have received my copy of the Call Book Third Edition and I want to thank you for it. I must say that it is wonderful and I would not want to be without a copy. Yours truly,
W. M. Oliver.
P. O. Box 127.

Some of the special information contained in the new book: Radio rate sheet (charges to and from vessels, etc.); Cable rates; Table for finding cable charges to various points; Weather reports and hydrographic reports of the world; Time signal section of the world; American, French, British and Canadian radio compass stations; General information section; International abbreviations; High power radio stations of the world; Press schedules of spark stations.

The only book in print officially listing all the Radio calls as issued by the Bureau of Commerce. Every vessel and land station in the world is listed alphabetically, according to names of vessels or land stations, and according to call letters; Revision of American coastal stations under U. S. Naval control, and their new calls.

Every New Amateur Call Is Listed

SPECIAL—Wireless Map of the World in Colors Given FREE With Each Copy

Price \$1.50 Prepaid

Either Direct from us or for sale by the following responsible Dealers:

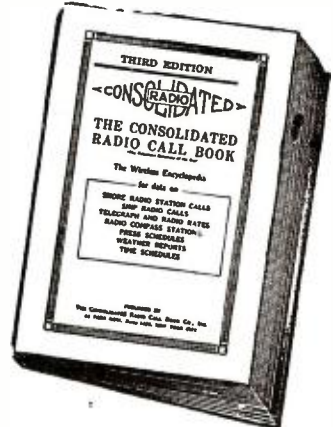

- American Electro Tech. Appliances Co., New York City
- American Hardware Stores, Bridgeport, Conn.
- Atlantic Radio Co., Boston, Mass.
- Bamberger & Co., Newark, N. J.
- Benwood Specialty Co., St. Louis, Mo.
- Brodie Electric Co., Los Angeles, Cal.
- Bunnell & Co., New York City
- California Electric Co., San Francisco, Cal.
- Catton, Neill & Co., Honolulu, T. H.
- Central Radio Co., Independence, Mo.
- Chicago Radio Apparatus Co., Chicago, Ill.
- Continental Radio & Electric Corp., New York City
- Cutting & Washington Radio Corp., Detroit, Mich.
- Detroit Radio Laboratories, Detroit, Mich.
- Dewey Sporting Goods Co., Milwaukee, Wis.
- Doubleday-Hill Electric Co., Pittsburgh, Pa.
- Electro Importing Co., New York City
- Findley Electric Co., Minneapolis, Minn.
- Fuller Co., Boston, Mass.
- Gurd & Co., London, Canada
- Hico Wireless Supply Co., Jacksonville, Fla.
- Holt Electric Utilities Co., New Bedford, Mass.
- Jenkins, Lester I., Trenton, N. J.
- Katzenbach & Co., Worcester, Mass.
- Kendall Co., New York City
- Killoch Co., Los Angeles, Cal.
- Kluge, Arno A., Detroit, Mich.
- Krause & Co., Philadelphia, Pa.
- Lehigh Radio Co., Philadelphia, Pa.
- Linze Electrical Supply Co., Philadelphia, Pa.
- McCarthy Bros. & Ford, Philadelphia, Pa.
- McClurg & Co., A. C., Philadelphia, Pa.
- Manhattan Electric Supply Co., New York City
- Meter Electrical Construction Co., New York City
- Meyberg Co., Leo, New York City
- Mohawk Electrical Supply Co., New York City
- New Era Shop, New York City
- Newman-Stern Co., New York City
- Nola Radio Co., New York City
- Noll & Co., E. P., New York City
- Northwest Radio Service Co., New York City
- N. S. W. Bookstall Co., New York City
- Pacent Electric Co., New York City
- Paramount Radio Supply So., New York City
- Parks, Henry Francis, New York City
- Pearlman's Book Shop, New York City
- Penn Radio Apparatus Co., New York City
- Pennsylvania Marconi Wireless School, Philadelphia, Pa.
- Philadelphia School of Wireless Telegraphy, Philadelphia, Pa.
- Piedmont Electric Co., Philadelphia, Pa.
- Pioneer Electric Co., Philadelphia, Pa.
- Pitts Co., F. D., Philadelphia, Pa.
- Post Office News Co., Philadelphia, Pa.
- Precision Equipment Co., Philadelphia, Pa.
- Radio Distributing Co., Philadelphia, Pa.
- Bethlehem, Pa.
- St. Louis, Mo.
- Buffalo, N. Y.
- Chicago, Ill.
- New York, Chicago
- Oshkosh, Wis.
- San Francisco, Cal.
- Syracuse, N. Y.
- Milwaukee, Wis.
- Cleveland, Ohio
- New Orleans, La.
- Philadelphia, Pa.
- Seattle, Wash.
- Sydney, Australia
- New York City
- Butte, Mont.
- Washington, D. C.
- Reading, Pa.
- Philadelphia, Pa.
- Philadelphia, Pa.
- Ashville, N. C.
- St. Paul, Minn.
- Boston, Mass.
- Chicago, Ill.
- Cincinnati, Ohio
- Newark, N. J.
- Radio Electric Co., Philadelphia, Pa.
- Radio Equipment Co., Philadelphia, Pa.
- Radioelectric Shop, Philadelphia, Pa.
- Ray-Di-Co., Philadelphia, Pa.
- Reuter Electric Co., Philadelphia, Pa.
- Riverside Laboratory, Philadelphia, Pa.
- Rose Radio Supply, Philadelphia, Pa.
- Saunders Co., Geo. S., Philadelphia, Pa.
- Schmidt & Co., Rudolph, Philadelphia, Pa.
- Sears, Roebuck & Co., Philadelphia, Pa.
- Service Radio School, Philadelphia, Pa.
- Shafers', Philadelphia, Pa.
- Shotton Radio Mfg. Co., Philadelphia, Pa.
- Smith Bros., Philadelphia, Pa.
- Smith Novotoy Electric, Inc., Philadelphia, Pa.
- Southern Electrical Supply Co., Philadelphia, Pa.
- United Radio Telegraphers' Assoc., Philadelphia, Pa.
- Western Radio Electric Co., Philadelphia, Pa.
- Whitall Electric Co., Philadelphia, Pa.
- White Co., The, Philadelphia, Pa.
- White & Boyer Co., Philadelphia, Pa.
- Williamson Electric Co., H. F., Philadelphia, Pa.
- Wilmington Electrical Specialty Co., Philadelphia, Pa.
- Wireless Mfg. Co., Philadelphia, Pa.
- Wireless Press, Philadelphia, Pa.
- Young & McCombs, Philadelphia, Pa.
- Young Men's Christian Assoc., Philadelphia, Pa.
- Zamolski Co., Jos. M., Philadelphia, Pa.
- Pittsburgh, Pa.
- Boston, Mass.
- Cleveland, Ohio
- Chicago, Ill.
- Cincinnati, Ohio
- Milwaukee, Wis.
- New Orleans, La.
- Boston, Mass.
- Rochester, N. Y.
- Chicago, Ill.
- Washington, D. C.
- Norfolk, Va.
- Scranton, Pa.
- Sarnia, Ont., Canada
- Charlotte, N. C.
- San Diego, Cal.
- Baltimore, Md.
- Los Angeles, Cal.
- Westerly, R. I.
- Columbus, Ga.
- Washington, D. C.
- Seattle, Wash.
- Wilmington, Del.
- Canton, Ohio
- New York City
- Rock Island, Ill.
- Los Angeles, Cal.
- Baltimore, Md.

Consolidated Radio Call Book Co., Inc., 98 Park Place, New York City

throughout the country will have to be provided with snappy demonstrations of radio. Last year in Vermont I heard a woman demonstrating a fonograf in a public school and I went in to see how she closed the deal. She showed the teachers how to use the machine for marching, folk dancing, and in developing appreciation of music. Incidentally she showed them how to save 80 per cent. of their needles by turning each needle a little after each record and using it five or six times. After the demonstration she answered a lot of questions and then, just as I was wondering who was to be the victim, she calmly packed up her outfit and went away.

It was the cleverest salesmanship I ever saw. I learned that she does the same thing the year round and gets big money for it. It sells more goods than any direct method. You see the country man goes on the defensive immediately when he meets a salesman. He has been stung too many times. His idea of a corporation is an octopus with a thousand arms, with an efficient blood sucker on the end of each one. When a corporation sends a representative to his town and this representative teaches him how to make the best use of what he has, how to save money instead of spending it, he listens guardedly and keeps repeating "No" under his breath to keep in practice. When the agent goes away without showing an order book or naming price or terms, it disarms the suspicious one entirely. In a day or two he is looking around the town for someone who can order one of them things for him.

If any dealer who reads this article says to himself: "There is a chance to sell goods," either I have failed or he is too dense to see the point. What I am trying to tell you is that in American country towns there is an opportunity to render public service from which big business will flow as naturally as water flows from a glacier when the summer sun shines upon it.

Radio Apparatus for Amateurs

(Continued from page 100)

the primary requisite for the use of such circuits, following is a description of another piece of apparatus which was recently built; this is a vacuum tube detector and two-stage amplifier.

Fig. 4 illustrates the exterior of this instrument and Fig. 5 shows an interior view of it. The connections will be understood by referring to Fig. 6.

The detector amplifier provides for one detector tube and two amplifier tubes, mounted on a strip of micarta and supported by a rubber shock-proof mounting. Access to the tubes is obtained thru the hinged door in the top.

The amplifying transformers, the determining factor in the efficiency of any amplifier, are of new design, embodying the good points of both the Army and Navy types.

Two rheostats provide for the control of the filament current, one being in series with the detector tube filament, and the other being connected in series with the two amplifying tubes.

Standard telephone jacks mounted on the front of the micarta panel make provision for connecting the telephone headset to either the detector tube alone, or to the first stage or second stage of the amplifier.

As in the tuner, all terminals are placed at the back of the instrument, and are arranged in such a way that the terminals on the two instruments which are to be connected together are adjacent, thus simplifying in the extreme the problem of connections. Each terminal is neatly engraved with its designating name, and it is practically impossible even for the novice to wire up the instrument incorrectly.

Station Type

In handsome mahogany cabinet, as shown.

\$30.00

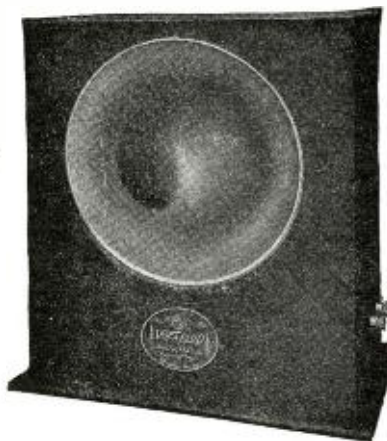

Laboratory Type

Mounted on metal base, adjustable height

\$25.00

The

VOCALLOUD

THE IDEAL loudspeaker. Requires no batteries, no adjustments, no extra equipment whatever. Just hook VOCALLOUD right on to your receiving apparatus

and listen to your signals, —QSA all over your house! Uses genuine Baldwin reproducer,—equally good for telephone and telegraph. Your order shipped at once!

CORWIN'S improved SWITCH LEVER

Sure contacts, smooth operation, handsome appearance—all are characteristics of this improved switch. Many switches give their manufacturers more profit—none give their users more satisfaction. Try a Corwin Switch. As good as it looks!



Send your order today!

PRICE:
90 cents,
Postage,
5 cents.

Composition knob, identical with knobs used on standard No. 67 Corwin Dial. Brass shaft is moulded right into knob — it can never come loose. Blade, bushings, etc., nickel-plated brass. Contact radius, 1/4 inch.

Universal-Coil Mounting Plugs

For Radisco and all hand wound coils. No bending, no filing, they fit exactly in the first place.

80 cents postpaid

All orders for apparatus not listed as postpaid must be accompanied by postage charges.

CORWIN'S 1921 CATALOG 10c

Send for your copy today!

New Radisco Vario-Coupler

Accurate to the .002 part of an inch. Moulded base, Formica tube, all metal parts brass.

\$7.50 postpaid

Remember Corwin's reputation for shipping mail orders promptly and in perfect condition.

A. H. CORWIN & CO.

Dept. B2, 4 W. Park St., Newark, N.J.

HOW ABOUT THAT CW SET?

Here are the units required for a complete CW transmitter that will put 10 or 20 watts into the antenna with 2 or 4 UV 202 power tubes. Operates entirely from 110 volts A.C. You may order the complete set or any units separately.

Acme Power Transformer	\$20.00
Northern Electric Oscillation Transformer (a real CW unit)	8.00
UV 202 Power Tube (2 or 4 required), each	8.00
Ward Leonard Grid Leak (5,000 ohms)	2.50
Dubilier Plate Circuit Condenser (2 required), each	2.00
Dubilier Grid Condenser	2.00
Shramco Filament Rheostat	2.00
Murdock Moulded Socket (2 or 4 required), each	1.00
General Radio Radiation Meter (0 to 2 amperes)	7.75

For maximum range with power tubes, the Northern Electric ROTARY MODULATOR should be used. It gives a pure clear note. Price complete without motor, \$10.00. Get our latest bulletins describing this modulator as well as our other CW units.

A complete blueprint of connections for this set is furnished with each order of \$2.00 or more. Notice that the above units are all standard, reliable makes. Take advantage of NORTHERN ELECTRIC CW service and send your inquiries to us. Our Engineering Department is ready to furnish technical data for all types of CW stations. This service is free.

Our apparatus is used in the better class of stations where real results are obtained. It costs no more to have YOUR station in this class.

NORTHERN ELECTRIC COMPANY, P. O. Box 371 Schenectady, New York

Miraco Radio Parts

We have the parts for that set you are building
Prices in Tune with the Times

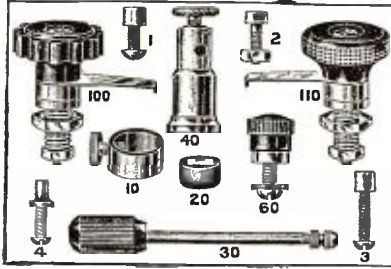

No. 1	1/4" x 1/4" contact point.....	.04
2	1/2" x 1/4" contact point.....	.05
3	7/32" x 7/32" contact point.....	.06
4	Switch stop.....	.06
10	Crystal detector cup, 5/8" diam.....	.35
20	Tested Galena in Woods alloy.....	.40
30	Detector rod with chuck.....	.35
40	Detector binding post.....	.35
60	Binding post with hard rubber top.....	.12
100	Switch lever, heavily knurled knob.....	.60
110	Switch lever, finely knurled knob.....	.60

All above parts polished nickel

Postpaid Immediate delivery

CATALOGUE FREE

MIDWEST RADIO COMPANY
3423 Dury Ave., Dept. A, Cincinnati, Ohio

A SMASHING HIT

The CROSLY V-T SOCKET 60c "BETTER—COSTS LESS"



This Socket is made of porcelain—the ideal material for the purpose. Our own special design makes possible the use of this material. Has many advantages over other types of sockets in addition to moderate price. Suitable for either panel or base mounting. If your dealer does not handle them, order direct and send us his name.

Watch for our announcement of new \$1.00 riable Condenser. We are also manufacturers of cabinets, CROSLY MAG-FON, and other radio apparatus. Write for circular matter.

DEALERS—It will pay you to handle our line. Write for full particulars.

CROSLY MANUFACTURING CO.

Dept. R.N. No. 2 CINCINNATI, OHIO

A BETTER "B" BATTERY for your Radio Set

CYCLONE BATTERIES World's Best "B" Batteries Variable and Plain

American products. Contains highest grade materials and best workmanship. Guaranteed to give the fullest and best satisfaction.

The best inducements for dealers.
Write for catalog.

Ask your dealer for Cyclone "B" Batteries or write direct to us.

Standard Electric Novelty Co.
182 Lafayette St. New York City

SPECIAL

One Omnigraph, 1000 ohm phone with headband, and buzzer, complete, for \$17.00. Short wave regenerative set, wave length range, 150-650 meters \$82.00.

Please include postage.

DREYFUSS SALES CORP.
179 GREENWICH ST. NEW YORK

Radio at New York Stock Exchange

(Continued from page 104)

when not actually in use, a transformer feeding a second transformer and an aerial and ground system.

As you have probably observed, there are no vacuum tubes, no condensers, no "B" batteries, no variable inductances, no complicated circuits or adjustments, such as generally are to be found when recourse is made to radio telephony. A few moments may be well spent in considering this simple system, in its application.

HOW IT WORKS

In the transmitting circuit, the primary of the first transformer is in series with the transmitter (microphone) and the 12-volt battery. When the operator desires to transmit, he merely pushes the button on the handle of the transmitter and talks into it. When he pushes the button, a current from the battery flows thru the circuit of the primary of the transformer, which is proportional to the resistance of the microphone circuit. The resistance of the microphone is changed by the voice waves to correspond to them and there is, therefore, a current flowing thru the primary of the transformer corresponding to the voice waves of the speaker. The secondary of this transformer furnishes the current for the primary of a second transformer, of somewhat the same formation as a telephone repeater coil and the secondary of the second transformer is connected to the aerial and ground. It will be readily seen that the fluctuations in the aerial and ground of the system will be of similar modulation to those in the microphone circuit, and will depend for their frequency and wave form upon the voice waves of the operator.

The aerial is made of enameled copper wire of about No. 18 B. & S. gauge and is supported by small, flat, fibre insulators and follows the balcony used by the chalkers, from end to end. There are three wires in use at present and they afford results which are entirely satisfactory. The author is firmly convinced of this, for, in company with Mr. Robert Lacault, Associate Editor of RADIO NEWS, he put the system thru a number of rather severe tests.

The ground has been made by covering the floor directly before the boards with galvanized iron sheeting, upon which the chalkers walk and the capacity effect of their bodies is made use of by connecting one side of the receiving set to their wrists by means of a spring bracelet, made from a clock spring. Some tests were made in which it was not even necessary to use the galvanized sheet ground, and the voice was distinctly heard by merely standing on the wood floor. The accompanying photos and diagrams show very clearly how the complete system is made and how it works, so that further description is unnecessary.

A FEW SHORT CUTS TO RICHES

The speed in getting sales on the boards in places of this character determines, to a great extent, whether or no a man is to make money or lose it, so we may well spend a moment in seeing how this radiofone is going to increase that speed. All the machines, which surround the boards and which may be found in the various brokerage and similar offices thruout the city are controlled by that single operator in the center of the floor of the exchange and it is impossible for him to send out information any faster than he can punch the keys on the automatic transmitter which he operates. Suppose that many sales of various stocks have been made in a comparatively short space of time and all the slips are piled up before him, the report of the last sale will not be made until he has been



NEW YORK BOSTON

Offers a thorough course in all branches of wireless telegraphy. Radio Operators earn at the start \$125.00 per month, and first class board, etc., free.

Our school prepares you for your license in three to four months. Positions guaranteed to first grade licensed operators. Also MORSE TELEGRAPHY.

Day and evening classes.

The leading Nautical School in U. S. A. Established 1804.

CAPTAIN F. E. UTTMARK, Principal

Write, call or phone for illustrated booklet.

8 STATE ST., NEW YORK, N. Y.

Facing Battery Park, N. Y.

Telephone, Bowling Green 8079

UTTMARK'S for Nautical Education



TELMACO goods are our own make. They are better in quality—lower priced—and will satisfy you always.

Our service is the very best. That is why we have three TELMACO stores, now open, to supply the big demand for our TELMACO brand as well as standard line of goods. We can serve you, too—by mail—equally well. Try us.

Attractive Proposition to the trade

MAGNAVOX DISTRIBUTORS
Maximum Discount Allowed Dealers
Prompt Deliveries

Our New Catalog "N" will be sent gratis. Write for YOUR copy today.

Radio Supplies Division

TELEPHONE MAINTENANCE CO.

17 N. LaSalle St., Chicago, Ill.

Meet us at the National A. R. R. L. Show, Booth No. 24.

Do You Know Doctor Mu?

ALKALINE STORAGE "B" BATTERIES

In oak cabinets, gives years of service without expert attention. Are not harmed from overcharging, short circuiting, or standing idle. Plain with clips, for single cell control, including rectifier, chemicals and directions. Thirty-two volts \$8.00; fifty volts \$10.00; sixty-eight volts \$12.00. Add 25% for batteries with control switches mounted in neatly engraved hard rubber panels. Pictures upon request.

KIMLEY ELECTRIC COMPANY
No. 280 Winslow Ave., Buffalo, N. Y.

STILL BETTER RADIO SERVICE

A postcard puts you on our mailing list for all literature.

EMPYREAN RADIO CO.
Masonic Temple — Chicago, Illinois

able to punch out all the others, and the relay, which obviously accompanies this method of getting the results on the tickers, may mean the loss of thousands of dollars to some of the traders. Then the men at the tickers shout the results to the men at the boards who in turn chalk them up.

Speech is very much more rapid than typewriting or punching out the results on the automatic transmitting machine, and with the wireless fone the men at the boards merely have to wait to hear one or more of the stocks they have charge of slating, and can put the figures upon the board immediately the reports of the sales reach the man at the transmitting set.

In addition to the use directly made of the radiofone system in use in the exchange, it will afford live brokers an opportunity to get a jump on the market, while others throuth the city are waiting for the results to come over the ticker. In all probability the ticker will remain in use for that purpose for many years and direct wires on the telephone mean delay from various circumstances, with which every user of it is familiar. By having an antenna swung from the ceiling of the building in which the trading is done the news of trade may be sent out simultaneously to the chalkers and those brokers who have their offices equipt with receiving sets.

There are brokers, having their offices in the immediate neighborhood of the exchange, who desire immediate information on certain stocks and by simply running a wire to a point somewhere near the outside of the exchange building they will be able to take advantage of this instantaneous reporting, and will sometimes have the reports several minutes before they would have them if they waited for the ticker. By special arrangement it will be possible to improve on the present radiofone system, so that such brokers will be able to transmit orders to their representatives on the floor, who will be equipt with these simple receiving sets, so that it will sometimes be possible for them to buy or sell before the determining information reaches the broker who, depending upon the ticker alone, has received it. The speed and accuracy of this system, as well as its entire simplicity, make it a very desirable adjunct to the stimulation of the big business where time means money.

I Want to Know

(Continued from page 126)

A. 2. Yes, this amplifier is suitable for arc, spark and fone as well.

Q. 3. What is the probable range in wave-lengths of the circuit?

A. 3. The range of wave-length depends upon the design of the radio frequency transformers. The signal corps instrument was designed to have the greatest efficiency between 100 and 1,100 meters.

SIMPLE RADIOFONE AND C. W. SET.

(245) Robert Buchert, of Westerville, Ohio, asks for information:

Q. 1. What kind of bulb is used in the C.W. hook-up on page 707, of the April, 1921, RADIO NEWS?

A. 1. If less than 100 volts are used on the plate, amplifying tubes may be used, and if the voltage is higher, a Radiotron U.V. 202, or a Moorhead transmitting tube should be used.

Q. 2. Could a modulation transformer and microphone be used instead of a key in this circuit?

A. 2. Yes. See hook-up on this page.

Q. 3. How many 45-volt batteries are necessary and what would be the average range for such a set?

A. 3. The range depends largely upon the aerial and ground and the surroundings. If in an open space, the range, under good conditions, may be two or three miles or more, using 90 to 100 volts on the plate and a V.T. detector at the receiving station.



Learn Telegraphy

(Wireless or Morse)

The **EASIEST, QUICKEST, CHEAPEST** WAY

AT HOME

In Half the Usual Time

WITH THE OMNIGRAPH

"Just Listen—The Omnigraph will do the teaching"

The Omnigraph is an *Automatic Transmitter* that teaches you both the Wireless and Morse Codes, at home, without any expense except the cost of the machine itself. Merely connect to battery and your Buzzer, or Buzzer and Head Phones, or to your Sounder and the Omnigraph will send unlimited messages by the hour, at any speed you desire.

USED BY THE U. S. GOVERNMENT

The Omnigraph is used by the Government in testing all applicants applying for a Radio License. It is also used extensively by the large Universities, Colleges and Telegraph Schools throughout the Country for teaching Wireless and Morse. Hundreds of the Army's skilled operators who served during the war learned with the Omnigraph.

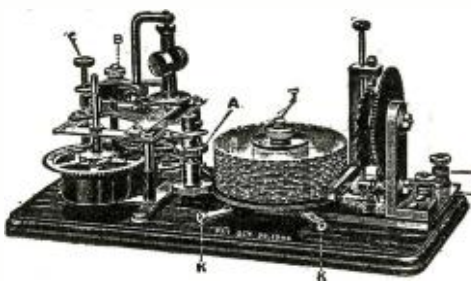

Let The OMNIGRAPH Teach You Wireless

For a few dollars you can have a complete outfit that will make you an experienced operator in the shortest possible time. No hard, laborious work—just learn by listening. The Omnigraph is adjustable so you can start receiving messages slowly, gradually increasing the speed as you become proficient.

You'll be surprised how quickly you will attain speed. Even if you are already an operator the Omnigraph will help you. It will make you more proficient, more accurate and more confident. Thousands of Omnigraphs are in use today and thousands of operators owe their success to them.

Write for Free Catalog

Send for a catalog today, showing the 3 different models, \$14 to \$30, or purchase through your Electrical Dealer. Every Omnigraph is sold with the absolute guarantee that you must be satisfied or your money back for the asking. Mail the coupon today—the catalog will come to you by return mail.

The Omnigraph Mfg. Co.
26 F Cortlandt St.,
New York City

Gentlemen:—

As per your ad in RADIO NEWS please mail me your free catalog of Omnigraphs.

Name

Address

City..... State.....

The Omnigraph Mfg. Co.
26 F. Cortlandt St., New York City

Chelsea Variable Condensers

(DIE CAST TYPE)

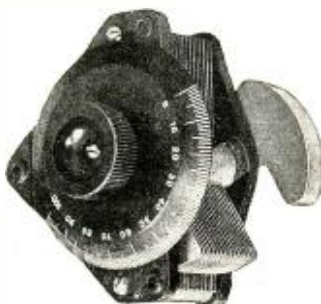

No.	Capacity	Type	Size	Weight	Price
1	.001m.f.	Mounted	4 1/4 x 4 1/2 x 3 1/4	1 1/2 lbs.	\$5.00
2	.0006m.f.	Mounted	4 1/4 x 4 1/2 x 2 1/2	1 1/4 lbs.	4.50
3	.001m.f.	Without Dial	4 1/4 x 3 x 4	2 lbs.	4.75
3	.001m.f.	Without Dial	4 1/4 x 3 x 4	2 lbs.	4.35
4	.0006m.f.	Without Dial	4 1/4 x 3 x 3 1/2	1 1/4 lbs.	4.25
4	.0006m.f.	Without Dial	4 1/4 x 3 x 3 1/2	1 1/4 lbs.	3.85

Top, bottom and knob are genuine bakelite, shaft of steel running in bronze bearings, adjustable tension on movable plates, large bakelite dial reading in hundredths, high capacity, amply separated and accurately spaced plates.

Unmounted types will fit any panel and are equipped with counter-weight.

Purchase from your dealer, if he does not carry it, send to us. Bulletin sent upon request.

CHELSEA RADIO CO., 17 Fifth St., Chelsea, Mass.

Manufacturers of Radio Apparatus and Moulders of Bakelite

OPPORTUNITY AD-LETS

Follow these advertisements every month. Reliable advertisers from all over the country offer you their most attractive specials in these columns.

Classified advertising rate six cents a word for each insertion. Ten per cent discount for 6 issues, 20 per cent discount for 12 issues. Name and address must be included at the above rate. Cash should accompany all classified advertisements unless placed by an accredited advertising agency. No advertisement for less than 10 words accepted.

Objectionable or misleading advertisements not accepted. Advertisements for the October issue must reach us not later than September 10.

THE CIRCULATION OF RADIO NEWS IS OVER 42,000

EXPERIMENTER PUBLISHING CO., INC., 233 and 236 Fulton Street, New York, N. Y.

Automobiles.

Automobile Owners, Garagemen, Mechanics, Repairmen, send for free copy of our current issue. It contains helpful, instructive information on overhauling, ignition troubles, wiring, carburetors, storage batteries, etc. Over 120 pages, illustrated. Send for free copy today. Automobile Digest, 528 Butler Bldg., Cincinnati.

Automobile Accessories.

Auto Motors Supplies—Buick, Michigan, Stoddard-Dayton, E. M. F., Cadillac, Overland, Continental and Buda Motors. All types, \$50 each and up. New Dixie magnets, \$20; Splittorf high tension magnets, \$10; Kellogg pumps \$3.50; Auto-Lite generators, new, \$10; air gauges, 65c; Remy ignition coils, new, \$3; electric and gas headlamps, coils, distributor heads, air compressors, etc. Write for catalog. Motor Sales Dept., 16 West End, Pittsburgh, Pa.

Motorcycles—Bicycles.

Don't Buy a bicycle motor attachment until you get our catalog and prices. Shaw Mfg. Co., Dept. 1608 Galesburg, Kans.

Used Parts for all motorcycles. Schuck Cycle Co., 1922 Westlake, Seattle, Wash.

Motors, Generators and Dynamos

Special Garage Motors—Manufactured by the General Electric Co.: 1 H.P., \$78.50; 2 H.P., \$110; 3 H.P., \$128.50; 5 H.P., \$168.50. All sizes both single and polyphase motors for immediate delivery. Special charging generators, all voltages. Write for catalog. Motor Sales, Dept. 16, West End, Pittsburgh, Pa.

Agents Wanted.

Big Money and fast sales. Every owner buys gold initials for his auto. You charge \$1.50; make \$1.35. Ten orders daily easy. Write for particulars and free samples. American Monogram Co., Dept. 133, East Orange, N. J.

We want Representatives, to sell radio station, household necessity. Radio Amateurs and Students given preference. Let us Pay for that set or Your Way through School. If you mean business send 50c for samples and territory proposition otherwise do not waste your money or our time. Box 612, Wellington, Ohio.

Books.

What? "Wireless Telegraphy and Telephony Simply Explained," by Alfred P. Morgan, 154 pages, 156 engravings, price, \$1.50. "Radio Hook-ups," by M. B. Sleeper, price 75 cents. "Design Data for Radio Transmitters and Receivers," by M. B. Sleeper, price 75 cents. "Radio Time Signal Receiver," by Austin C. LeScarboura, price 35 cents. "Construction of a Trans-Atlantic Wireless Receiving Set," by L. G. Pacent and T. S. Curtiss, 36 pages, 23 illustrations, price 35 cents. Complete your radio library. Radio Distributing Co., Abilene, Kansas.

We Buy and Sell back issues of Radio Amateur News and Electrical Experimenter. Boston Magazine Exchange, 109 Mountfort St., Boston, Mass.

Concordia Magazine, Quarterly, 9 Water, York, Penna. prints essays, stories, current events, poetry, formulas and plans. Send \$1 for three-year subscription.

Business Opportunities.

Substantial Manufacturing Corporation wants capable men to establish branch and manage salesmen; \$300 to \$2,000 necessary. Will allow expenses to Baltimore as explained. Address Mr. Clemmer, 603 N. Eutaw St., Baltimore, Md.

Correspondence Courses.

Dollars Saved—Used correspondence courses of all kinds sold, rented and exchanged. List free. (Courses bought.) Lee Mountain, Pisgah, Alabama.

Chemistry

Learn Chemistry at Home.—Dr. T. O'Connor Sloane, noted educator and scientific authority, will teach you. Our home study correspondence course fits you to take a position as chemist. See our full page ad on page 91 of this issue. Chemical Institute of New York, 150 Nassau Street, N. Y. City.

Electrical Supplies and Appliances.

New Idea.—Weld, Melt, Cut, Fuse conductors or non-conductors any size. Inexpensive. Very Simple Printed Sketch and details 54c money order. Be early before price advances. George Sabol, 47 Mitchell Ave., Clairton, Pa.

Storage Batteries for automobiles. We furnish all parts and moulds for making them. Sample plate, 40c. Foreign countries, 50c. Windsor Specialty Co., 5419 Windsor Ave., Chicago, Ill.

Electricians—Wiremen, linemen, send your name and address for descriptive literature of our modern blue print chart method of electrical wiring. Over 350 practical diagrams. Electrical Wiring Diagram Co., Box C-173, Altoona, Pa.

For Men.

Tested Razors sent on free trial. Zitka, Fairview, Mass.

For Advertisers.

Don't Wait for Business.—Advertise and get it. We will help you. Jacobus Service, 41 Bruen, Irvington, N. J.

For Inventors.

Model Making and Experimental Work of every description. Manufacturing. Lamson Model & Experimental Works, 625 W. Jackson Blvd., Chicago.

Formulas.

Formulas—Guaranteed correct. Absolutely any subject desired. No lists, 50c each. Van Martin, Ft. McArthur, Calif.

Help Wanted.

Detectives Earn Big Money. Excellent opportunity. Travel. Great demand everywhere. Fascinating work. Experience unnecessary. Particulars free. Write, American Detective System, 1968 Broadway, New York.

Earn \$25 Weekly, spare time, writing for newspapers, magazines. Experience unnecessary; details free. Press Syndicate, 5665, St. Louis, Mo.

Be a Mirror Expert. \$3-\$10 a day; spare time home at first; no capital; we train, start you making and silvering mirrors, French method. Free prospectus. W. R. Derr, Pres., 579 Decatur St., Brooklyn, N. Y.

Radio Operators—Amateur radio operators wanted to form a communication division 1st Battalion Naval Militia and U. S. N. R. F. Practical work and instruction radio and radio telephones. Many Summer advantages. Week-end and fifteen-day cruises in Eagle boats to West Indian ports. Retainer pay while serving, full pay when cruising. No interference with civilian duties. Inquire any Monday evening, Communication Officer, U. S. S. Granite State, foot W. 97th St. (via 96th St. and Broadway), North River, Manhattan.

Health.

Tobacco or Snuff Habit Cured or no pay; \$1 if cured. Remedy sent on trial. Superba Co., SB, Baltimore, Md.

Pyorrhea (Riga's disease—bleeding or swollen gums)—hundreds have been helped by "Pyorrdin" the successful home pyorrhea treatment. Purifying, healing, preventative. Full month's treatment, consisting of a very beneficial massage paste and an antiseptic tooth-cleansing paste to be used in place of your ordinary dentifrice, together with full directions for treatment, \$1 postpaid. Or write for free booklet "R." Pyorrdin Mfg. Co., 439 Seventh St., Brooklyn, N. Y.

Instruction.

Mathematics Taught By Mail—Spare time home study course, including arithmetic, geometry, algebra, and trigonometry. J. A. Harding, 76 Brighton Ave., Highland Park, Mich.

Learn Chemistry at Home.—Dr. T. O'Connor Sloane, noted educator and scientific authority, will teach you. Our home study correspondence course fits you to take a position as chemist. See our full page ad on page 91 of this issue. Chemical Institute of New York, 150 Nassau Street, N. Y. City.

Motion Pictures

Movie Projector, \$5 to \$25. Films 250 feet, \$2 postpaid. Werner Brothers, High Ridge, Mo.

Novelties.

Genuine Indian Baskets. Wholesale catalogue, Marion Gilhams, Kelseyville, Calif.

Patent Attorneys.

Patents—Send for free book. Contains valuable information for inventors. Send sketch of your invention for free opinion of its patentable nature. Prompt service; twenty years' experience. Talbert & Talbert, 440 Talbert Bldg., Washington, D. C.

Patents Secured. Prompt service. Avoid dangerous delays. Send for our "Record of Invention" form and Free Book telling How to Obtain a Patent. Send sketch or model for examination. Preliminary advice without charge. Highest references. Write today. J. L. Jackson & Co., 133 Ouray Bldg., Washington, D. C.

E. T. Brandenburg (former patent expert, Ordnance Division, War Department), Attorney-at-law and Solicitor of Patents, 927 Loan and Trust Bldg., Washington, D. C. Send sketch and description, or model of your invention for careful investigation at Patent Office and unbiased report as to patentability.

Millions Spent Annually for Ideas. Hundreds now wanted! Patent yours and profit! Write today for free books—tell how to protect yourself, how to invent, ideas wanted, how we help you sell, etc., 301 Patent Dept., American Industries, Inc., Washington, D. C.

News Correspondents

Earn \$25 Weekly, spare time, writing for newspapers, magazines. Experience unnecessary; details free. Press Syndicate, 566 St. Louis, Mo.

Phonographs.

Build a genuine Choraleon phonograph and save over half. Fine profits building and selling. We furnish motors, tone arms and necessary parts. Send for our catalog and free blueprint offer. Choraleon Phonograph Co., 821 15th St., Elkhart, Indiana.

Photo Developing.

Get Acquainted Offer—Mail us 20c with any size film or six negatives for development and six velvet prints. Twenty-four hour service. Fine work. Roanoke Photo Finishing Co., 324 Bell Ave., Roanoke, Va.

Your film and 25c brings you prints made with attractive border designs. Something new. New England Photo Service, Box 1202, Boston, Mass.

Printing.

Your name on 100 cards with case, 60c postpaid. Log Cabin Printer, 289 So. Bayview Ave., Freeport, Long Island.

Labels, 60c per 1,000 up. Irvin J. Wolf, Station E, Philadelphia.

Everything Printed.—Long run specialists. Samples. Quality Printery, Marietta, Ohio.

Stamps and Coins.

Stamp Collection, 2500 diff. in Modern Album. Cat. \$30. Prepaid, \$8.50. Ernest J. Hanson, Delavan, Wis.

1000 Different Stamps, \$3; 500, \$1.25; 200, 25c; 100, 12c. Approvals. Michaels, 5602 Prairie, Chicago.

Stamps—100 different, 11c; 200, 21c; 50 U. S., 10c; 1000 mixed U. S., 18c. Robert Mosher, 323 New St., Newark, N. J.

50 Different Stamps, best packet we ever offered. Austria, Estonia, Germany, Hungary, Liechtenstein, Serbia, Turkey. All for 10c. catalog value over \$1.50 sent to applicants for approvals only. Lakewood Stamp Company, Dept. R, Lakewood, Ohio.

Song Writers.

Song Writers!—Learn of the public's demand for songs suitable for dancing and the opportunities greatly changed conditions offer new writers, obtainable only in our "Song Writers' Manual and Guide," sent free. Submit your ideas for songs at once for free criticism and advice. We revise, poems, compose music, secure copyright and facilitate free publication or outright sale of songs. Knickerbocker Studios, 319 Galety Bldg., New York.

Scenery for Hire.

Settings for all operas and plays. Catalog. Amella Grain, Philadelphia.

Stammering.

Stammerers.—You can be permanently cured by my course of private individual lessons. Interesting booklet free. Samuel I. Robbins, 246 Huntington Avenue, Boston.

St-Stu-t-t-tering and Stammering cured at home. Instructive booklet free. Walter McDonnell, 121 Potomac Bank Bldg., Washington, D. C.

Telegraphy.

Memorize Continental Code in one hour. Qualify quickly for amateur license. No instrument. See our ad on page 132, this issue. C. K. Dudge.

Wanted to Buy

Send to Cleveland by mail or express any old or broken watches, false teeth, old or broken jewelry, brooches, bracelets, old gold, silver, platinum, diamonds, magneto points, platinum wire, contact points or crucibles, mercury, and anything valuable. We pay the highest prices in cash by return mail. Goods returned in ten days if you're not satisfied. The Ohio Smelting & Refining Company, 207 Lennox Bldg., Cleveland, Ohio.

Exchange.

Selling out, used but not abused receiving apparatus. Variable condensers, rheostats' sockets, honeycomb coils, etc., write me for bargains. Ralph G. Roesch, 2924 Portmann Ave., Cleveland, O.

For Sale.—Proudfoot detector and 2 step amplifier, new \$18; Montgomery Ward regenerative receiver, new, \$18. Send for list of more A-1 condition apparatus, cheap. Wesley Robinson, Jr., St. Mary's, Georgia.

(Exchange continued)

Bargains.—RLC 3S21 Mignon 10,000 meter receiving cabinet, new. \$60 will sell for \$30; $\frac{1}{4}$ K. W. Thordarson, \$9; 2 in. coil with electrolytic interrupter. \$8; send stamp for list and particulars. Milton Ehlers 515 Garfield Ave. Milwaukee, Wisconsin.

For Sale.—Mignon RC2. \$14; Tron Detector with bulb, one filament good, \$8; DeForest audion bulb, \$4; Murdock 55 Headset, \$3.75; Brandes Superior, with cord, \$5; Murdock 23 plate HV Condenser, \$3.75; Thordarson 1 K. W. Flexible Transformer, \$20; Rotary Gap, \$15; Oscillation Transformer, \$5; 3 sections RTS Condenser, \$6; Key, \$2; B Battery described page 517 Feb. Radio News, complete, \$15; Materials for 275 ft. aerial, \$15; Telegraph instruments, etc. Will ship C. O. D. Write for complete list and descriptions. Harry Boyce, Mt. Vernon, Indiana.

Grab's Type Short Wave Regenerative set forty-five dollars. Detector and two step amplifier with jacks and plugs, forty-five dollars. Storage battery, six volts; eighty amperes. fifteen dollars. Redhead phones four dollars. First one hundred dollar money order only takes everything. Will throw in tube and B battery to boot. Clevelanders invited up. Three-quarter kilowatt Thordarson transformer. Eighteen dollars. Harry Bernbaum, 673 E. 91st St., Cleveland, O.

Trade—One twin cylinder Indian motorcycle engine with Bosch magneto for good wireless transmitter. Donald Beeth, Tucumcari, New Mexico.

Sell DeForest two step receiver and 16 coils \$220 information on request. Richard Brown, Monessen, Pa.

Radio Magnavox, brand new in original shipping crate. First money order for \$35, gets it. Herman Rinkinberger, Bradford, Ill.

For Sale.—Western Electric Induction Motor, A. C., 1/6HP., \$10. Universal Crystal detector, \$4; Hamilton Beach, A. C. 7000 R. P. M., \$10; Marconi type oscillation transformer, 1 K. W., \$8; Pancake OT $\frac{1}{2}$ K. W., \$4.50; Mignon RLC5 special long wave receiver, cost \$150, sell \$30; Blitzen short wave receiver, \$15; Brandes superior phones, \$5; two stage amplifier, second transformer missing, \$20; crystal detector No. AA, \$2.50. That Lab at Baton Rouge, La., 645 Mills Ave.

Trade 8 Vol. Library of Practical Elect. new by Croft for wireless apparatus. Geo. W. Healy, R2 Box 218, Olympia, Wash.

All kinds of radio instruments, cheap. Homer Hudelson, Durrelth, Indiana.

Storage Battery.—6v. 60 amp., new. \$12; 43 plate Clapp-Eastham condenser, \$4.50; potentiometer, \$1.50; 15000-15,000 meter loading coil, \$3.50; home made glass plate transmitting condenser run a 2 in. coil, \$2. Everything guaranteed. Milwaukee Radio Lab., 910 Third St., Milwaukee, Wis.

Sell Murdock Condensers.—Fine condition. 2-43's, \$3.25; 1-23, \$2.25, postpaid. Rex Reinhardt, 60 Rivoli St., San Francisco Calif.

Sell small 6 volt storage battery celluloid casing \$7; \$15 movie machine automatic reinder with film. \$6. Wm. Reith, 4913 Ogden St., Philadelphia.

For Sale.—Long wave and short wave regenerative set, with phones and B battery, \$50; short wave regenerative, \$30; panel transmitter, \$8; pocket receiver, \$5. Haskhoff, 35 Grosvenor, Springfield, Mass.

Wireless Apparatus.—Cheap. Receivers, tuner, etc. Stitt, Thief Falls, Minn.

Exchange.—A portable pool and billiard table, 36 x 72 inches in A-1 condition. Will trade for two-step amplifier or \$30 cash. Wm. Theesefeld, Windom, Minn.

For Sale.—Radio 9CA spark and CW cheap. write for list. Walter Taylor, Minonk, Illinois.

For Sale.—One stage amplifier using Western Electric transformer has standard tube socket and clips for Meyers Tube. base but no cabinet, \$12; Western Electric V. T. 1, \$5; Century buzzer, \$1; DeForest tube socket, \$1; Chelsea oscillator, \$2; Universal detector with mounted Ferroncrystals, \$2.50; one section Murdock moulded condenser, \$2. E. Winquist, 106 Wilkinson Ave., Jersey City, N. J.

Sell Short wave variometer receiver. \$35; Honeycomb tuner with honeycombs, \$50; detector and two step amplifier, \$35; detector and two step with regenerative tuner, \$75. Want magnavox. Write F. Mann, 327 4th Ave., New York City.

Sell—1 set of drawing instruments, \$6.50; good condition; 1 pair motorcycle tires, \$2.50 (used). Send for list. Mele, 39 Foxon, East Haven, Conn.

For Sale.—Tresco long wave tuner, Colby's short wave tuner, Navy type coupler, amplifying transformer, Marconi Class II bulb, rheostats, vacuum tube sockets, condensers. Write for list and prices. James Parker, 33 Holland Ave., Ardmore, Pa.

For Sale.—Murdock coupler, \$4.50; audion control RORH Grebe, \$10, practically new. John Pearce, 6227 Ingleside Ave., Chicago, Ill.

Audion Panel, five dollars; Amplifier, ten dollars, no junk. J. Francis, 6553 Woodward, Detroit.

Exchange Radioson, loading inductance, variable, prefer Spider-Web coils. Foster, 5LC, Muldoon, Texas.

Bargain.—Front and Rear motorcycle wheels with good casings, \$7.50 each; 1 and 2 cylinder Bosh H. T. magnets, \$15 each. saddle, \$3.50. Eclips belt clutch, \$5; chain roller, \$1.25; block, \$1; Stevens Favorite, \$4.75. Money talks. Glenn Ellis, Francistias, Texas.

DeForest Honeycomb coils for sale Cheap. Alex Ellsworth, Fowlerville, Mich.

For Sale.—Complete wireless set including antenna. Write Theo. Elliott, Wilmoit, Kans.

Selling.—Complete $\frac{1}{2}$ kilowatt sending and audion receiving set or parts. Stid. goods. Get complete list, Exzleton, 1527 Addison Rd., Cleveland, O.

Sell—Receiving transformer six dollars; control panel, eight dollars; Murdock Con., four dollars; detector, two dollars; $\frac{1}{2}$ K. W. transformer, nine dollars. All new but last. Chas. Dill, Hamilton, Mont.

Sell or Swap.—Complete wireless outfit, cheap. Also bicycle. Write, A. Drill, Wheeler St., Woodstock, Ill.

For Sale.—Complete portable movie outfit (in Kansas City). High power British telescope. Prismatic compass; Smith motor wheel, camera, plate. Will exchange for long wave length radio equipment or what have you. C. B. Lewis, Profit, Vir.

(Exchange continued)

Sell.—64-B Spencer microscope. In perfect condition. Also chemical laboratory. Walter Kiohr, Towson, Md.

Bargains!—W. E. Vt. 2 power tube, \$10.50; W. E. Vt 1 tube, \$7; 2 filament tubes, \$3.50; C. E. 43 plate condenser, \$3.50; DeForest 90° condenser with leak, \$3.50; wireless shop, 63 plate, \$4.75; W. S. 43 plate condenser, \$3.50; Detector set in gum wood cabinet with E. R. tube, \$10; Baldies, \$14; W. E. tubes, new, rest used 2 months or less. H. Jones, Ferndale, Wash.

17 Plate Variable Condenser, postpaid, \$1.25. Geo. Jurok, 2642 Ballou St., Chicago.

For Sale.—2000 M loose coupler, \$4.50; Helix, \$1.50; key, \$1; 6V. 60A. storage battery, \$6.50; 2 $\frac{1}{2}$ " spark coils, \$1.50 each. Gulon Hall, 327 W. Pearl St., Jack-son, Mississippi.

For Sale.—Hy-Rod rotor with electrodes, \$8; Thordarson oil immersed condenser, \$15. Joe Hill, 1572 Virginia St., Charleston, W. Va.

Sell.—Mignon RCl tuner, 200-5000 M., \$13.50 good condition. Mignon BD1 detector, less tube, \$9.50; Murdock's 55's, \$2.50; 4v. 50a storage battery, guaranteed, \$9. Galen Baker, Clay City, Ind.

Sell.—Audiotron control cabinet with the tube and "B". Honeycomb control cabinet with 2 .001 VC's and coils, \$70, or what am I offered? Donnell, Hampton, N. H.

Regenerative Receiver with detector unit; first money order for \$45 gets outfit. W. G. Conger, Independence, Mo.

For Sale.—New 5 dial omnigraph. Bargain, \$10. R. Carlson, Franklin Hotel, Chicago.

Sell.—3,500 meter crystal receiving outfit, Murdock phones, \$18; signal short wave receiving transformer, new, \$10; detector and one-step amplifier, \$15; regenerative receiver, \$11. George Brown, 13 Prince St., Pawtucket, R. I.

Sell.—2 unused, high-grade variometers; 1 coupler, \$16. M. O. A. Benesowitz, Hibbing, Minn.

For Sale.—Grebe CR-6, \$85. Wanted: Paragon RA-6 cheap, must be genuine. Barrett, 3150 Central Ave., Indianapolis, Indiana.

Brand New Turney Spiderweb inductance, \$5.50. Ash-ton Godley, Wallingford, Pa.

Bargain.—15 dial omnigraph for 15 dollars. New, works perfect. Harold Gould, 344 Fifth St., South Boston, Mass.

Nearly New. \$30 White Cross Vibrator outfit with case. For sale at \$15. Albert W. Griffin, Linesville, Pa.

Western Electric 4400 Ohm fones, \$10; Murdock 3000 Ohms, \$4.50; 90 V. D. C. generator, \$6; E.E's Feb. 1918 to date, 25c each. L. Arthur, 3428 Evergreen Terrace, Baltimore, Md.

Four Federal amplifying transformers, new, \$3 each. Add postage. H. Butterworth, 331 Quincy St., Brooklyn, N. Y.

Sell.—\$55 CRL 2 step like new, \$29; R74 DeForest audion, \$4; 43 plate variable, \$3; Navy coupler, \$10; Century buzzer, 75c; Murdock condenser and detector, 75c; DeForest 101 amplifier, \$2; VT socket, 85c; satisfaction or refund. H. J. Burhop, Manitowoc, Wis., 92L.

For Sale.—Cheap, radio apparatus. Call or write. S. Boyar, 281 Brook Ave., Bronx, New York City.

For Sale.—3 Radisco coils. No. 325-3, \$1.25 each; 1 rotary gap, \$14. F. Brautlecht, Yardley, Pa.

Bargains.—Triple honeycomb receiver and detector on bakelite panel in Mahogany cabinet complete with B battery, condensers, coils mounting rheostat tube mounting, etc., \$45; $\frac{1}{2}$ K.W. arc set operates on 110 D.C. includes radiation meter, arc, microphone, rheostat, condenser, choke, etc., complete for phone or C. W. work, on bakelite panel, \$55. Shore wave regenerative receiver, oak cabinet, bakelite panel complete with variometers, varicoupler, rheostat, tube mounting, etc., \$30. Photos and descriptions on request. Myron Brown, East Marlon, N. Y.

Sell DeForest 14 panel set, phones, B battery, tubes, \$85. Hawkins guides, \$8. Harold Richey, 328 Harrison Ave., Vandergrift, Pa.

Desk Telephones.—Guaranteed good working condition—prepaid, \$3.50. Durant Rice, 1321 So. 35th Ave., Omaha, Nebr.

Amateurs.—To introduce our Star Cabinets will sell a limited number of them, size 8 x 5 x 6 in., at \$1.50 each. These cabinets are just the size for a roomy audion control panel. Made of $\frac{1}{4}$ inch oak. Unfinished. Satisfaction or money refunded if returned 3 days after receipt, in good condition (include postage for 3 lbs. parcel post). Star Cabinet Shop, 7th & Chestnut Sts., Lansdale, Montgomery Co., Pa.

Bargain.—Audion detector and two stage amplifier, in cabinet, jack control, \$25. Joseph Smith, 1290 Velvidere Ave., Detroit, Mich.

Want to Buy.—Baldwin phones cheap. Alex Serna, Ada, Okla.

Amateurs.—Cabinets made to your specifications. Give us a trial. Write for estimate. Star Cabinet Shop, 7th & Chestnut Sts., Lansdale, Montgomery Co., Pa.

Sell.—No. 13 single cotton magnet wire 40c lb., fine for aerials, etc., postage extra. A. C. Uish, Box 350, Marion, Ohio.

First money order takes Signal R-37 tuner, \$35. Klitzen variometer in case, \$8; Mesco buzzer, \$2; Solar gas lamp, \$3.25; Perfection rheostat, \$1.25; large key, \$2.50; compass, 65c; Expo watch camera, \$2; Weedon horizontal steam engine, \$2.75. All A-1 condition. Herbert Mayer, Route 5, Plymouth, Wis.

First money order for \$25 takes two good Western Electric VT1 tubes, four burnt out Moorhead and one burnt out Western Electric VT1. One DeForest unit panel crystal detector and a plain gap. Purchaser pays transportation charges. Winthrop High, 58 Newfield St., East Orange, N. J.

For Sale.—Complete wireless telegraph and telephone set including new A and B batteries. Price fifty dollars. Write for description. R. S. Hope, Denmark, S. C.

Library, Practical Electricity, twenty-one dollars. Thomas Hughes, 236 Piano St., Newark, New Jersey.

(Exchange continued)

Must Sell Quick.—Famous CRL Paragon with AGI detector and amplifier; Westinghouse receiver with detector and two step, cost \$125; Young and McCombs receiver and detector, uses DeForest coils, cost \$37; DeForest mounting, cost \$13; Acme quarter, half and one k.w. transformers; Acme cw transformer, two hundred watt; Acme modulation transformer and amplifiers; vocoolud cost \$25; Saco detector and two step amplifier cost \$75; NoStax paris, cost \$10; Barr-Mercury cup detector; Modern loud speakers, cost \$15; Midcut Ammeters; above goods all new, cash offers considered first. Have good used Universal regenerative receiver, cost \$100. Benwood gap cost \$30; consider trades. Sell new radio magnavox, never opened, \$34.75; magnavox tone arm, \$28.50; F-F bantam battery boosters, \$13.65; two tube radio-phones, radiates 1 amp. or more, with c.w. transformer, ready to hook to ac. except tubes, and variable, \$115. First come first served. V. Hicks, Marion, Illinois.

Selling out.—Grebe CR3—A-1 condition, \$45; $\frac{1}{4}$ K.W. quenched, \$33.50. Everett Decker, 2100 Richmond Terrace, Port Richmond, New York City.

Selling Out.—Model of Grebe CR6 automatic filament control and grounding shield with three tubes, \$90; 90V B battery, \$3.75; phones and plug, \$4.75; loud speaker, \$9.50; 250 amp. Hr. Edison, \$38. E. Diemer, 7702 Edgewood Ave., Swissvale, Pa.

Wireless.

Generator 350 watt 500 volt DC for CW work. Bargain, \$30. Chas. McNary, Washington, Pa.

Stop! Look! and Act! V.T.'s. With each radiotron u.v. 200 V.T. detector or A-P Moorehead V.T. detector or radiotron u.v. 201 V.T. Amp. or A-P Moorehead V.T. amp., we will supply free of charge your choice of either a Murdock V.T. socket improved contact type, or a Remler Bakelite smooth running rheostat latest type, or a Chelsea bakelite grid condenser with clear India mica dielectric, or a 3/4 in. Chelsea Bakelite knob and dial complete. Radiotron u.v. 200, \$5. Radiotron Amp. V.T. u.v. 201, \$6.50; Moorhead A-P detector, \$6; Moorhead A-P Amp. V.T., \$7; Remler Bakelite Rheostat latest type, \$1; Murdock V.T. socket, \$1; Chelsea India mica grid condenser, 75c; Chelsea Bakelite dial and knob, \$1; Paragon Rheostats, \$1.75; Paragon V.T. control panels, \$6; Federal amplifying transformers, \$7.50; Radio Corporation of America's latest amplifying transformer u. v. 712, magneto shield, especially designed by General Electric Co. for use with Radiotron V.T.'s, \$7; Remler control panels, \$8; Burgess B batteries, largest size, 2 1/2 volts with 1 year life, \$3.50. We absolutely guarantee the foregoing apparatus. Only new and high grade equipment carried in stock. All orders are filled within twelve hours and shipped postpaid and insured, thereby saving time and money. Remember us, The Kehler Radio Laboratories, Dept. R, Abilene, Kansas.

Just Think! new short wave regenerative. Selective, no capacity effect, no dead end, 150 to 750 meters, only two controls (three hands not needed), easy to tune, and compact (5x5x9). Price \$25. Write for foto. Satisfaction or money refunded. Port Arthur Radio Laboratories, 2048 Fifth St., Port Arthur, Texas.

Oak Cabinets 7" x 18" x 6" finished light or dark oak, \$3.50; other sizes in proportion; Litz one and one-half cents per foot; vocooluder variometer balls 70c No. 22 DCF 30c quarter pound. Meade Bakelite Radio Apparatus, 522 Central Ave., Brooklyn, N. Y.

Special Sale of Parts for Radio Apparatus.—In order to liquidate a large stock we are offering at practically half price the following sets of complete units ready for assembly. This is an excellent opportunity to make a start in wireless. We have the following ready for immediate shipment by parcel post prepaid, on receipt of remittance. Receiving tuner, 600: 2000 meter loose coupler, \$2; Variable condenser, 6000 M.F., \$3; Crystal detector, 70c; No. 14 antenna wire, 100 ft. coil, 60c; transmitting helix, \$2; $\frac{1}{2}$ " spark coil (complete assembly), \$3.50; zinc spark gap with polished bakelite base, 70c; hand key, 50c; $\frac{1}{2}$ KW radio transformer, \$8; 1000 ohm head phones, single, \$2; 2000 ohm head phones, double, \$3.75; strain insulators, 8c each; mica transmitting condensers .002 mfd., \$2.50. No catalogues. Send orders immediately. Kilbourne & Clark Mfg. Co., Seattle, Wash.

Ford Spark Coils, primary, secondary and core, complete, 50c. Eugene Grossman, 14 E. Read St., Baltimore, Md.

Aluminum Condenser Plates, 5 cents. Washer 5 cents dozen, 10 cents for samples. Gravenstede, Great Kills, Staten Island, N. Y.

A Real Set, range 150 to 3000 meters. The most efficient and inexpensive set manufactured. It uses one bulb and varicoupling. It eclipses all other sets of its wave length in sensitiveness. This set is sold complete for \$50 by Scott R. Copp'ng, Princeton, Ill.

New Stock.—Marconi V. T. bulbs, \$5 each. Cyco Radio Co., 1608 Blue Island Ave., Chicago.

Southwestern Radio Amateurs.—We have a complete line of radio apparatus and represent over 35 radio manufacturers. We sell only high grade standard apparatus. We make immediate shipments. The Alamo Radio Electric Company, 608 W. Evergreen St., San Antonio, Texas.

Special Offer.—Until August 15 we are offering the Turney Spiderweb Short Wave Regenerative Set (150 to 400 meters). List price \$8 at \$5. Radio Distributing Co., Abilene, Kansas.

Slab Inductances.—Set of eight, tuning with .001 MFD condenser from 300 to 30,000 meters. Forward money order, \$4, made payable at Atlantic Road, Brixton to Perry 9 Jelf Road Brixton, London, England, and secure a set post free by return.

Audion Detector and Amplifier, V.T., 50 cents. Flancom coil mountings, 25 cents. Rack mounted rheostats, 40 cents. Composition for molding your own knobs, panels, etc. 35c pound. Send stamp for particulars. Palmers Electrical Equipment Co., Palmers, Minn.

Radio apparatus built to order. If you know what you want but haven't the time or equipment to build it write for estimate. R. Pringle, 1098 Ryde St., St. Paul, Minn.

Orders filled in 12 hours. The Kehler Radio Laboratories.

(Continued on page 174)



**FOUR
COLOR
COVER**

**100
PAGES
or MORE**

The Undisputed Authority on Simplified Science and Mechanics

SCIENCE & INVENTION is just chock full of interesting articles and illustrations that appeal to everyone. It will hold your interest from cover to cover because it contains everything new in the field of science, invention and mechanics. Quoted by hundreds of newspapers and magazines all over the world every month.

Its editorial contributors constitute the brains of the scientific world. Just a few of the regular contributors to Science and Invention include such prominent men as

- | | | |
|----------------------------|-----------------------------|-----------------------------|
| Thos. A. Edison | Prof. Jean Baquerel | Dr. A. O. Rankine |
| Nikola Tesla | Prof. Quirino Majorano | Prof. H. E. Austin |
| Dr. Lee DeForest | Maj. Gen. Geo. O. Cotton, | Dr. H. A. Cotton, Medical |
| Rogers D. Rusk, M.A. | Chief Signal Officer, U. S. | Director, N. J. State Hos- |
| James H. Rogers, Ph.D. | Army | pital |
| Isabel M. Lewis, of the U. | Dr. Robert H. Goddard | John J. Furia, M.A. |
| S. Naval Observatory | Hon. Jas. D. Hartness, Gov- | Hereward Carrington, Ph.D. |
| Prof. T. O'Connor Sloane, | ernor State of Vermont | Prof. H. F. Richards, Ph.D. |
| Ph.D., LL.D. | Dr. C. S. Brainin, Ph.D. | William M. Butterfield |
| Prof. Augustus Trowbridge | Prof. F. L. Darrow | G. L. Hoadley, M.E. |
| Dr. Alfred Gradenwitz | Dr. A. W. Hull, Ph.D. | Dr. E. Bade |

Exclusive Radio Articles A Special Feature

Every issue of Science and Invention contains an entire section of exclusive feature radio articles, written by the highest authorities on this timely subject. Profusely illustrated and treated in an entirely different manner than those in any other magazine. This Radio Section is one of the most popular features of Science and Invention.

OTHER REGULAR DEPARTMENTS

- "How to Make It"—a department devoted to stimulate experimenters towards accomplishing new things with old apparatus or old material. Three money prizes are offered each month for the most useful, practical and original ideas submitted.
- "Wrinkles, Recipes, Formulas"—a section containing interesting information about chemical experiments.
- "Latest Patents"—a most interesting department containing illustrations and articles describing the very latest patents.
- "Scientific Humor"—this department contains a collection of jokes contributed by our readers for which a money prize is offered each month for the best.
- "The Oracle"—a department devoted for the sole benefit of scientific experimenters where questions are answered every month for our readers.
- "Motor Hints"—containing many hints of vital interest to the chauffeur and owner alike, together with illustrations. Three money prizes are offered each month to the contributors of the best articles for this department.
- "Home Mechanics"—this section contains numerous articles, together with illustrations, showing how to make useful articles for the home from old or unused material.
- "Home Electrics"—a most hintful department by G. L. Hoadley, M.E., with its many articles and illustrations showing how one may take advantage of electricity as a labor-saving device, at the minimum possible cost.
- "Practical Chemical Experiments"—a department by Professor Floyd L. Darrow, in which he shows by plain wording and illustrations how to make simple food tests.
- "The Constructor"—this section contains hintful and practical ideas by H. Johnstone on how the amateur may build or construct useful things in a quick, cheap manner.
- "Popular Astronomy"—by Isabel M. Lewis, the well known author on astronomy.
- "Fortunes From Little Things"—Charles Frederick Carter writes this department, in which he gives some startling information—how inventors have been made rich quick by inventing simple but useful articles.

**ON SALE AT ALL NEWS STANDS—
25c THE COPY**

Subscribe for a year and save 50c. Get the twelve big interesting issues delivered monthly to your door by mail without further trouble to you. Use the coupon.

**Experimenter Publishing Company
231 Fulton Street New York**

Special Offer for 'Short Time' Only

Gentlemen:

Please enter my subscription for *Science and Invention* for the term of one year for which I enclose herewith \$2.50 (add 50c for postage outside of United States.)

Name..... Town.....

Address..... State.....

(Continued from page 173)
(Wireless continued)

Radiotron Power Tubes. Do We? Yes. We supply free of charge with each Radio Corporation of America 5 w.at power tube u.v. 202 a 5000 ohm, size M grid leak with midtap at 3500 ohms, especially designed to be used with it, and with each 50 watt tube U.V. 203, a special 5000 ohm size B grid leak with mid tap at 2500 ohm size M grid leak, \$1.10; size B grid leak, \$1.65. Specifications of u.v. 202. Power tube: Filament voltage 7.5 v. filament current 2.35 amperes. Normal plate voltage 350 v. normal plate current .045 amperes. Normal output 50 watts, price \$8. U.V. 203 power tube, filament voltage 10 v. filament current 6.5 amperes. Normal plate voltage 1000 v. Normal plate current .35 amperes. Normal output 50 watts, price \$40. R. C. Standard rheostat, Model P.R. 535, designed for u.v. 202, \$3. R. C. Standard rheostat, Model P. T. 537, designed for u.v. 203, \$10. R. C. Standard porcelain socket, Model U. R. 542, for U.V. 202, \$1. R. C. Standard porcelain socket, Model U.T. 541, for radiotron U.V. 203, \$2.50. Kinotron rectifier u.v. 210-20 watt (for 5 w.at radiotron), \$7.50. Kinotron rectifier u.v. 217-150 watt (for use with 50-watt radiotron), \$36.50. Power transformer U.P. 1016-750 watts for tube sets, \$38.50. Power transformer U.P. 1368-325 watt, \$25. Anti-hum box for kinotron rectifier sets. Filter condenser, filter reactor. Magnetic modulator for radio telephony u.p. 1367 100 watt. U.P. 1357/10-20 watt. Microphone transformer Y-414, \$7.25. Reactor-plate circuit, 5 watt tube sets, Y-415, \$5.75. Sending key U. Q809 for tube sets, \$3. Antenna ammeters U.M. 533, 0-5 amp., \$6.25. U.M. 530, 0-2.5 amp., \$6. Grid condenser and plate circuit by-pass condenser No. 577, \$2. Special antenna series condenser No. 580 for tube sets, three capacities .0003, .0004, .0005 M.F.D., \$5.40. Oscillation transformer U.L. 1008 for tube sets, \$11. The foregoing apparatus is designed and manufactured for the radiotron power tubes by the General Electrical Co. whose world-wide reputation insures high grade workmanship. We absolutely guarantee their products. Orders supplied with operating instructions, are filled within 12 hours and are shipped postpaid and insured. Remember us! The Kehler Radio Laboratories, Dept. R, Abilene, Kansas.

Stop! Look! But Don't Read.—Audion control panels. Detector, \$5.50; amplifier, \$10; detector has grid condenser, leak, variable "B" battery switch, etc. Send stamp for circular "A". Watch for our ad next month. Devore Radio Supply Co., Gibson City, Illinois.

Orders filled in 12 hours. The Kehler Radio Laboratories.

Blue Prints—We put your favorite hook-up on tracing cloth, 9 x 12 inches for 50 cents, three for \$1.25. You can then make all prints you want. Have you obtained our VT diagrams for receiving and phone sets? They are making a hit. 50 cents for either set of 12 separate sheets. Full range of circuits at your finger tips. We prepare drawings, carrying out your ideas for any kind of apparatus. Fine drafting at dirt cheap rates. Cabinet sets planned. Send stamp. Fine wall print of Continental Code, 6 by 28 inches, 25 cents. Reable 30 feet. No stamps with orders. The Plan Bureau, 1929 McCausland Ave., St. Louis, Mo.

Costs too much? Oh, no! On Sept. 30 we shall give everyone a chance to buy a reliable amplifying transformer of correct design at the lowest price on the market. We are offering the Clapp-Eastham Amplifying Transformer, which gives results second to none (same as illustrated in recent issue of Radio News), list price \$4, at \$3.45 postpaid. Immediate delivery. Guaranteed. Subject to return if not satisfied. The Radio Distributing Co., Abilene, Kansas.

Oh, Boy! Grebe Special—Type CR-3. The Grebe special—short-wave regenerative receiver type CR-3 (150 to 350 meters, with stunt capacity, 250 to 680 meters), recognized as the standard among all professional amateurs, will, for a limited time, be sold in a combination offer. With each set purchased from us we will supply free of charge your choice of one of the following: Paragon vacuum tube control, \$6; Radiotron u.v. 200 V.T. detector, \$5; Moorhead A-P V.T. detector, \$6; pair of Murdock 2000 ohm phones, \$4.50; Type CR-3, price \$65. Was illustrated in May issue of Radio News. Only new and high grade apparatus carried in stock. All goods subject to return after five days trial if not satisfied. Orders filled in twelve hours. The Kehler Radio Laboratories, Dept. R, Abilene, Kansas.

Unit Receiving Inductances assure satisfactory, efficient, and unparalleled long distance reception of all forms of radio transmission. For long wave work our Bi-Lattice coils (duo-lateral) need no introduction. For short wave reception a set of single layer coils compares favorably with the best regeneratives; and the cost is but a fraction of the regular regenerative receiver. Send 3c for bulletin. Our prices and service will surprise you. P. J. Stockwell, Box 157-C, Reading, Mass.

Sacrifice large cabinet set, tube detector, one stage amplifier, B batteries, 6v. 80 amp. Battery table, baldwin phones and transmitting set all mounted on white marble panel having washing basket full of miscellaneous, all for \$100. Also amateurs and millimeters celebrating set. Call or Write, R. Strauss, 1381 Avenue A, between 73d and 74th St., New York.

Radiophone Concerts.—Would you like to tune in easily and clearly the radiophone concerts in the ether and on the other hand be able to transmit them yourself with practically no more apparatus or power than used to receive them? If so, it will pay you to get acquainted with the Electrical Specialty Regenerative Receiver and Radiophone (150 to 600 meters). This set although designed for radiophone and C. W. reception brings in spark signals as clearly and loudly as the best on the market. The secret lies in the construction of the variometers and variocoupler with bakelite framework throughout and with capacity reduced to nil, thereby permitting very sharp and close tuning. In addition to its use as a regenerative receiver the Esco regenerative receiver may be used as a radiophone. By actual experiment a hook-up has been discovered whereby with the use of a microphone and a simple detector unit, distances of from 10 to 40 miles have been covered with the Esco receiver. The human voice and all kinds of music have already been transmitted in this manner. The hook-up and full instructions for its use are available to every purchaser of an Esco set. Wiring diagram, full instructions for operation and wave-length chart are furnished with each receiver, price \$50. Bulletin on request. As a further inducement we will supply for a limited time free of charge with each set your choice of a Paragon V.T. control unit, a pair of Murdock 1000 ohm phones, a radiotron U.V. 200 V.T. detector or a Moorhead A-P V.T. detector. Only new and high grade apparatus carried in stock. Orders filled within twelve hours. Unsatisfactory goods subject to return in five days. The Kehler Radio Laboratories, Dept. R, Abilene, Kansas.

Make A Visit to Radio Wonderland—

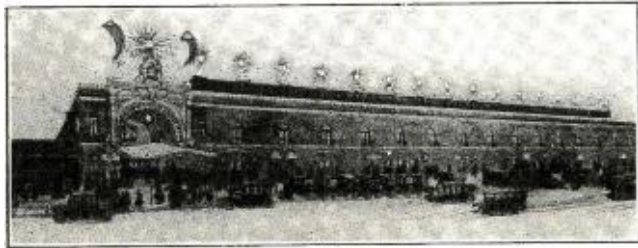

Broadway Armory
Broadway at Thorndale
Chicago, Illinois

The First National Radio Show

in conjunction with the

National A. R. R. L. Convention

Chicago

Aug. 31, Sept. 1, 2 & 3, 1921

The A. R. R. L. Convention



YOU stand upon the threshold of a modern wonderland—a spectacle of the progress in the science of radio communication.

As you step onto the floor of that immense Broadway Armory, you will at once be filled with awe by the marvelous exhibits that greet you. It will indeed be a sight to behold such as has never before been witnessed in radio circles. All arranged in model booths and finely decorated in one accord, it will equal in splendor any of the successful motor shows.

Come by all means, and bring your friends and relatives, for such a display as this will prove of great interest to every member of the family. Take the surface, elevated or motor bus line to Broadway and Thorndale, Chicago.

The radio exposition will be open August 31st to September 3rd inclusive from ten A. M. until midnight.

Mr. Manufacturer and Mr. Dealer, Everywhere, U. S.: have you arranged to have an exhibit at this first national show which marks the opening of a more active radio season? If not, you are probably overlooking the fact that your immediate competitor is going to be there to convince the thousands of radiomen from every part of the country, there assembled, that he has a superior product and will proceed to land their order right then and there.

It is an opportunity of a lifetime. Take advantage of it now by writing or telegraphing for show space to the show director

N. E. WUNDERLICH

4533 No. Sawyer Avenue,
Chicago, Illinois



THRU the many years of amateur radio there has developed an increasing desire to meet the other fellows that are, like yourself, interested in radio communication either as a pastime or business. And now comes a time when your wishes shall be gratified.

For, in Chicago on August 30, 31, September 1, 2 and 3, 1921, the American Radio Relay League will hold a First National Convention and Radio Show, which everyone is cordially invited to attend.

Chicago is itself a wonderful summer resort, offering every opportunity in any sport or diversion. You will never regret having spent part of your vacation here. The details of the convention are exceedingly comprehensive and every minute of the convention will be taken up with interesting and educational conference and lectures, being in all a most complete and co-ordinated program. Mornings, afternoons and evenings are fully arranged for, so that you will remember this convention as some of the most enjoyable days of your life.

There will be people that you know and many that you do not know that will be present from every district and city in this great United States. Probably the most important feature of the convention will be the huge banquet on the night of September 3rd, and there should be none failing to attend. Everybody from the Young Squirt up to President Harding will be there to pass you the sugar and tell you what a record station he or she is going to have this season.

The first day will be given over entirely to the arrival, registration and locating of the many delegates. The program will start promptly at ten A. M., August 31st, so you should arrange to be in Chicago some time during the previous day, August 30th.

We have arranged to accommodate you at the finest hotels in the city, very close to all activities, at rates from two dollars per day up.

From the moment that each delegate arrives, and they should not forget to bring the ladies, until their departure, the utmost of consideration will be devoted to their safety, comfort and pleasure.

Convention delegates will be admitted to the meetings, lectures, sportive expeditions and the Radio Show without any charge.

Banquet charges will be five dollars per plate, and reservations should be made immediately with convention reservation manager,

N. C. BOS

118 No. LaSalle Street
Chicago, Illinois

(Make all remittances payable to Chicago Executive Radio Council)

UNDER ADMINISTRATION OF THE CHICAGO EXECUTIVE RADIO COUNCIL

FADA Radio-fax

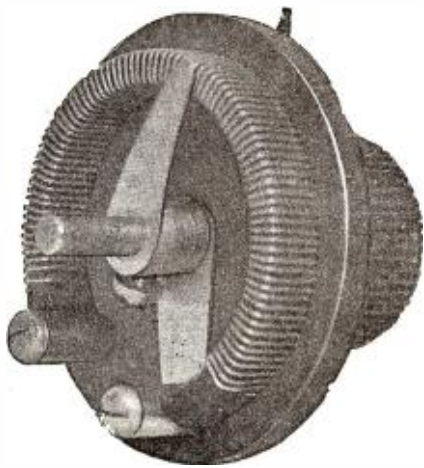

FADA PANEL MOUNTING RHEOSTAT

Facts—that's what every advertisement of FADA radio products contains. With a dictionary to pick from it's easy to describe any kind of apparatus in beautiful sounding language that doesn't mean anything to *you*. To keep down to facts and make every FADA instrument and part live up to such specifications is our accomplishment as manufacturers.

FADA panel-mounting RHEOSTATS

are the best that you can get for only \$1.25—it's a fact. The heat resisting Thermoplax base, small dimensions ($2\frac{1}{8}$ " dia.), fine appearance and the fact that it can be smoothly adjusted has made it popular among amateurs. Buy them from your electrical or radio dealer or post paid for only

\$1.25 each

FADA VACUUM TUBE DETECTORS and AMPLIFIERS

include these four instruments:

Detector Control Panel	\$17.50
Detector and One Stage Amplifier.....	45.00
Detector and Two Stage Amplifier.....	65.00
Two Stage Amplifier.....	50.00

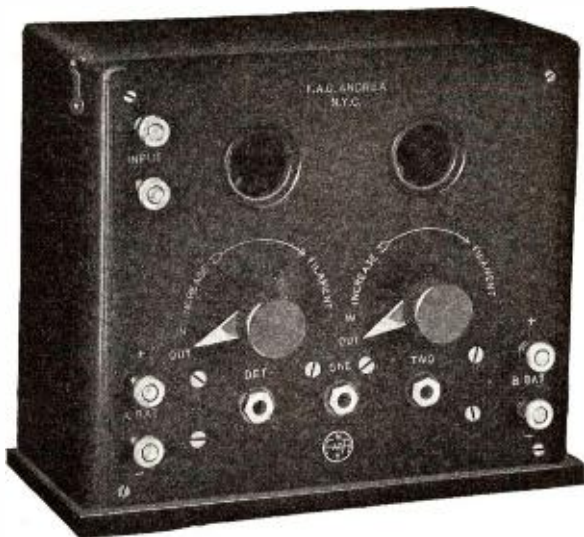

ABOVE—FRONT OF TWO-STAGE AMPLIFIER

Facts about their design and quality are: Panels: Genuine Bakelite XX, $\frac{1}{8}$ " thick, milled edges and hand grained finish. Cabinets: Quartered oak, beautiful ebony finish, with hinged covers. Tube Sockets: Bases of Bakelite XX. Contact strips of phosphor bronze and set into milled slots. Amplifying Transformers: The new Federal transformers are used having correct windings for the impedance of the tubes now on the market. Automatic Filament Control: Telephone jacks provide automatic filament control which saves your batteries and the life of the vacuum tube. Binding Posts: FADA non-removable top binding posts are used. Blueprints: A blueprint of the connections on the cover of every cabinet. Engraving: Finest machine engraving filled in with a pure white enamel. Wiring and General Appearance: The wiring is most carefully done on the bus-bar plan. Assembly work just as good and the appearance of a completed instrument proves our ability as workmen. Operation: Careful tests under actual working signal conditions given every instrument.

RADIO EQUIPMENT DEALERS: *Facts for you too, Mr. Dealer. FADA instruments and parts are fast moving merchandise. If you desire to sell the highest quality goods at prices the buyer gladly pays, write me your plans and get mine.*

FRANK A. D. ANDREA

Manufacturer of FADA Radio Instruments

1882-A Jerome Avenue

New York City

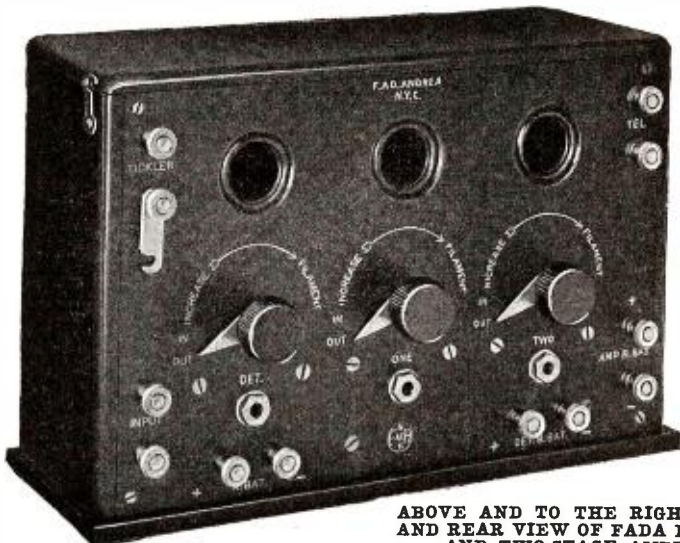

ABOVE AND TO THE RIGHT—FRONT AND REAR VIEW OF FADA DETECTOR AND TWO-STAGE AMPLIFIER

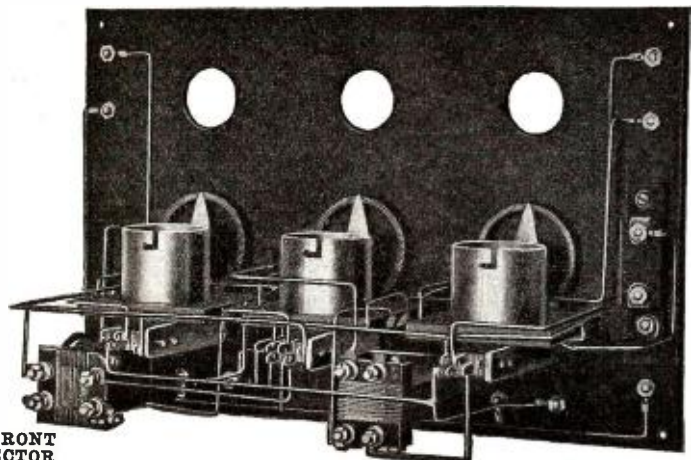

IF EDISON ASKED YOU

(These) Electrical Questions - How Many Could You Answer?

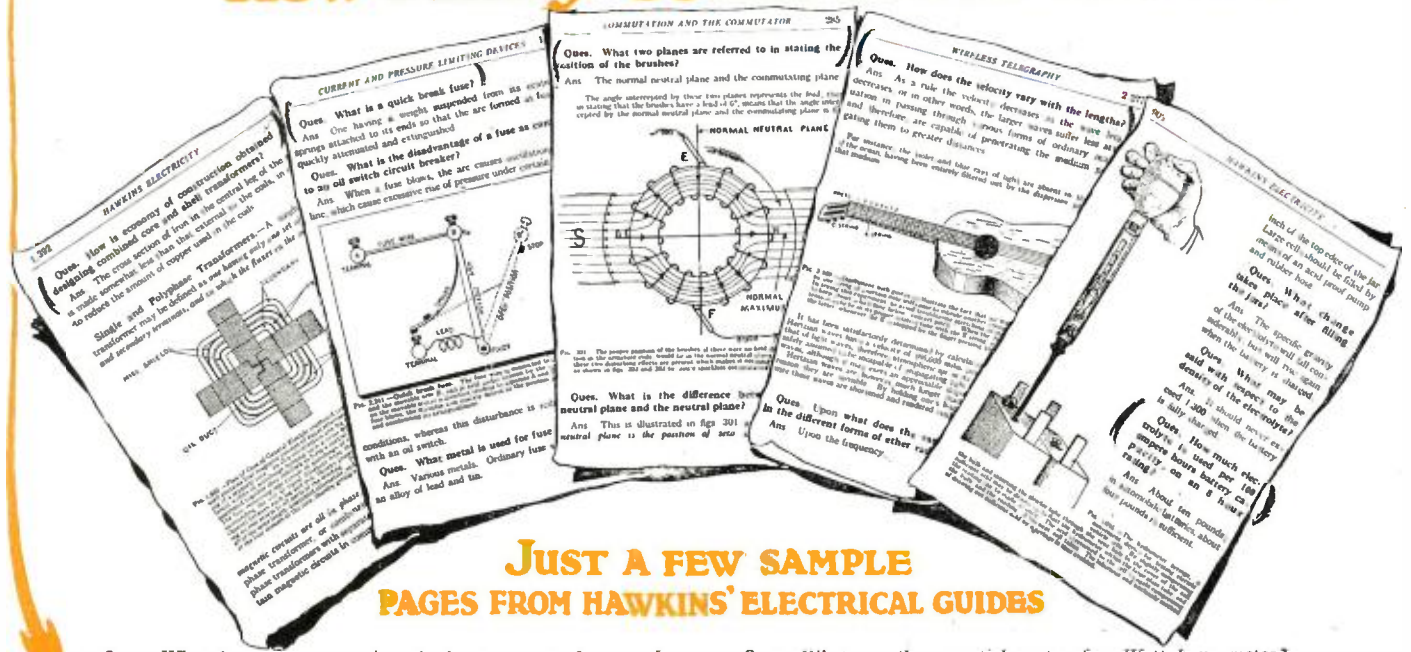

JUST A FEW SAMPLE PAGES FROM HAWKINS' ELECTRICAL GUIDES

- Ques. What form of core requires the least amount of copper for the field magnetizing coils and why? (For answer see Guide No. 1, Page 207)
- Ques. What error is introduced in measuring the pressure of a battery with an ordinary voltmeter? (For answer see Guide No. 2, Page 467)
- Ques. What is a kick box? (For answer see Guide No. 3, Page 776)
- Ques. What is a compositely excited alternator? (For answer see Guide No. 4, Page 1191)
- Ques. What is the character of the constructions of three phase transformers? (For answer see Guide No. 5, Page 1439)
- Ques. What are the essential parts of a Watt hour meter? (For answer see Guide No. 6, Page 1801)
- Ques. What kind of current is used to ring party bells? (For answer see Guide No. 7, Page 2148)
- Ques. (In radio telegraphy) How do the wave lengths of different forms of radiant energy emitted by ordinary matter vary? (For answer see Guide No. 8, Page 2274)
- Ques. How is a wire supported in the single catenary construction? (For answer see Guide No. 9, Page 2624)
- Ques. (In electro-plating work) What is stripping? (For answer see Guide No. 10, Page 3145)

Hawkins' Electrical Guides

Flexible Covers—Handy Pocket Size Volumes. 10 Volumes—3500 Pages—4700 Pictures \$1 per Volume—\$1 per month

THESE guides are not only a complete Course in Electricity in Question and Answer Form, but an invaluable reference library that every electrical man should have. Ten volumes, Pocket size, flexible covers, handsomely bound, 3,500 Pages, 4,700 Illustrations.

These books will give you a complete electrical education. Hawkins' Electrical Guides will teach you electricity. With them the student is lead progressively and in such a way that he easily grasps not only the simple fundamentals, but also the more complex problems that will come up in his future work. Thousands of successful electrical men acquired their electrical education from these books.

If you are already a practical electrical man, the Hawkins' Guides are absolutely essential to your success.

WE WILL SHIP THE COMPLETE LIBRARY FREE for YOUR INSPECTION

It will cost you nothing to receive these books—to look them over—ask them all the questions you can think of—use them in your work—study them—pick up some information that will increase your earning ability. We will ship you the entire set of 10 volumes entirely FREE.

This is a sign of our confidence in the guides. Pure gold does not object to being tested. Keep them for seven days and if you do not decide that you can't get along without them, return them to us and owe us nothing.

When you decide to keep them you only have to pay \$1.00 down and remit the balance of \$9.00 on the easy payment of \$1.00 a month till paid for.

Use this coupon to get the books. It will pay you many times over.

THEO. AUDEL & CO.

72 Fifth Ave. New York, N. Y.

Theo. Audel & Co.
72 FIFTH AVENUE
NEW YORK

Please submit me for examination Hawkins' Electrical Guides (price \$1 each). Ship at once, prepaid, the 10 numbers. If satisfactory, I agree to send you \$1 within seven days and to further mail you \$1 each month until paid.

Signature.....
Occupation.....
Employed by.....
Residence.....
Reference.....

R. N. Aug. 21



Do Amateurs Realize the Wireless Opportunities that Await Them?

How the President of the National Radio Institute Answered this Question When It Was Put Up to Him. What Would You Have Said? Is the World's Fastest-Growing Field Actually Going to Slip Away From Those Best Able to Cash In Big On It? These Are Questions Which Will Interest Every Radio Amateur.



Mr. James E. Smith, President National Radio Institute

THAT was one of the questions recently put up to me by a well-known authority visiting Washington. "In your opinion," he said, "do amateurs realize the wireless opportunities that await them?" For a moment I was stumped! Then I replied, "Yes, with just one 'but.' I think that amateurs are well aware of the tremendous expansion of wireless that is daily going on. They realize that it is sweeping the world like wild-fire. BUT I do not think that they realize what this means to *them*—they do not realize that they can easily get the 'plums' that the field offers. They 'have the jump' on everyone else, and they should realize now

that 'the fastest-growing field in the world' besides being a fascinating hobby is a wonderful, opportunity-filled field offering splendid present advantages—and growing so rapidly that the future is beyond estimation!"

I wonder if many amateurs have ever considered the fact that what is to them a fascinating hobby is also a fascinating profession, filled with big opportunities that they can easily share whenever they are ready to do so. It's only a short step for them now to a splendid field that they can put their hearts into—and offering a bigger future than older businesses which are overcrowded.

Big Opportunities Are Knocking—Are Some of Us Saying "Please Go 'Way and Let Me Sleep?"

After the caller who started me thinking about this matter had left, I jotted down on my pad some of the items which I had recently noted regarding wireless expansion. On land and on sea big opportunities are opening, and even greater uses for wireless are being found every day. No doubt you too have read these items, but I am going to have them printed here because I want to impress upon you what this tremendous expansion can mean to you.

When I read every day how wireless expansion is sweeping over the world I often say to myself, "Big opportunities are knocking—I wonder if amateurs realize that they can cash in big on this growing field. While opportunities knock, I wonder if some aren't saying, 'Please go 'way and let me sleep.'" Of course, they aren't sleeping by any means, but I want *all* of them to know just how easy it is to fully qualify for a field which is undeniably filled with greater advantages than most others in the world today.

Easy to Qualify In Spare Time At Home

I want to tell you—without obligation to yourself in any way—more about wireless opportunities and how you can take advantage of them. I would like to tell you about our Institute, which

is officially recognized by the U. S. Dept. of Commerce and whose name heads the list of the schools recommended by the U. S. Shipping Board. This National Radio Institute was the original and is today the oldest and largest school in America teaching wireless by

mail. The government allows our graduates five to ten points credit when taking First Grade Government License examinations. We have graduates in almost every part of the world who have quickly qualified through the special method through which we make Wireless amazingly easy for anyone to learn completely at home in spare time.

These are some of the main points about this Institute and I am sorry I haven't room to tell you all of them. I should like to tell you more about our wonderful new methods of teaching, about our remarkable new invention, the "Natrometer," which each student gets free, and which almost cuts in half the time necessary to learn Wireless thoroughly. Then too I'd like to tell you about our free Post-Graduate Course and about "Dots and Dashes," about our Diploma, our Relay League, Employment Service, and about our special easy-payment plan. But there is not enough room here to tell you about all these things so I am going to ask you to write me for a new interesting booklet we have gotten up.

Write Me For Booklet

A little coupon is being put here so that you can save yourself trouble in sending for this illustrated booklet, "Wireless, the Opportunity of Today." By mailing this coupon you will not be obligating yourself in any way and no solicitor will call upon you. But the coupon *will* bring you some mighty interesting facts about Wireless Opportunities and about how you can quickly and easily qualify for them—at home and in your spare time.

Won't you mail this little coupon at once? Whether you are a junior Radio Amateur and want to learn all about Wireless or whether you are anxious to fully qualify so as to enter the wireless profession now in one of the fine opportunities open on land or on sea—write me for this booklet. All that I ask is that you write as soon as possible. And—since there is no obligation—why not write me today!

P. S.—By the way, we are making a special short-time offer, for a strictly limited time, in which we are giving all new students, our complete new course in Wireless Telephony FREE. Mail the coupon direct to me, today, and let me tell you about it by return mail. Mr. James E. Smith, President, The National Radio Institute, Dept. 18, Washington, D. C. Residence Schools in Washington and Baltimore.

What I Jotted Down

Here are the items I jotted down on my pad, showing how Wireless is growing by leaps and bounds all over the world. Let me tell you what this world-wide sweep of wireless expansion means to you and to your future.

A \$20,000,000 American corporation has been formed to establish wireless stations in every part of the globe.

The U. S. Merchant Marine operates over 30,000 vessels. Wireless is now a necessity on ships.

The Chicago Tribune now receives foreign news by wireless. Other papers are calling upon Wireless too.

Huge wireless stations are springing up all over the world. Saint Assise, France; Bordeaux, Ville Juif, and Lyons, France; Peking, China; Geneva, Switzerland; Shanghai, China; Fiji Islands; Warsaw, Poland—and these are but a few.

Many railroads are calling upon wireless to dispatch trains and carry on communication. The Lackawanna, The Louisville & Nashville, The Canadian-Pacific, The Nashville, Chattanooga & St. Louis, are some of them.—New York, Cleveland, Chicago and Detroit are connected by an inter-city wireless service.

Criminals are being intercepted by wireless through the Police Department of New York, Dallas, Chicago, and other cities.

Brokers, Bankers, Merchants, Manufacturers and other business concerns are calling upon wireless. John Wanamaker, Goodyear Rubber Co., Standard Oil Co., New York Stock Exchange, are only a few.

Farmers are getting Market and Weather reports daily by wireless in all sections of the country.

New wireless stations are springing up in every part of America. Belfast, Maine; Cape May, N. J.; East Pittsburgh, Pa.; San Francisco, Cal.; Helena, Montana; Seattle, Washington; Mobile, Alabama—these are but a few.

The Aerial Mail Service of the Post Office Department already has 12 radio stations in operation.

The Japanese are constructing a powerful station in the Orient.

A big new wireless service is being established between England and France.

The Federal Telegraph Co. is establishing a complete chain of stations on the Pacific Coast.

Messages are sent from the Philippine Islands to Washington (10,000 miles) in 3 minutes.

Daily wireless service between the United States and Japan is in full operation.—St. Johns, New Foundland, is operating a large service.

Danzig, in Europe, is carrying on large wireless operations.

Three tremendous stations are operating on Long Island at Easthampton, Port Jefferson, and East Moriches.

South America is planning to establish a chain of stations at Rio de Janeiro, Asuncion, Buenos Aires and Montevideo.

One single American concern offers wireless communication between the United States and France, England, Germany, Norway, Denmark, Sweden, Finland, Poland, Honolulu and Japan.

And these are only a few of the examples showing how Wireless expansion is spreading over the whole earth. It brings you amazing opportunities—and you can now easily grasp them.

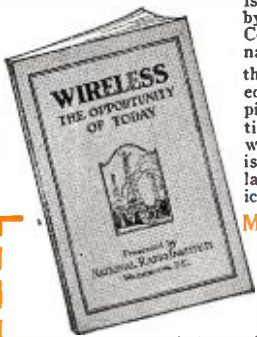

MAIL THIS COUPON TODAY

Mr. James E. Smith, President, National Radio Institute, Dept. 18, Washington, D. C. Send me your FREE book, "Wireless, the Opportunity of Today." Tell me about your Institute and your special short-time offer.

Name

Age

Address

City

State

I am interested in a sea position.

I am interested in a land position.